

Serie 55000

RACCORDI AUTOMATICI IN TECNOPOLIMERO

CARATTERISTICHE TECNICHE



Norma di Riferimento

1907/2006
REACH

2011/65/CE
RoHS

PED
2014/68/UE

ISO
14743:2020

SILICON
FREE

1	Corpo in ottone nichelato
2	Spintore sgancio tubo resina acetalica
3	Capsula in ottone nichelato
4	Pinza d'aggraffaggio in acciaio inox aisi 301
5	Anello di posizionamento in tecnopolimero
6	Guarnizione sagomata in nbr
7	Guarnizione filetto in nbr
8	Basetta Filettata in Ottone Nichelato
9	Corpo in tecnopolimero PA
10	Guarnizione in nbr

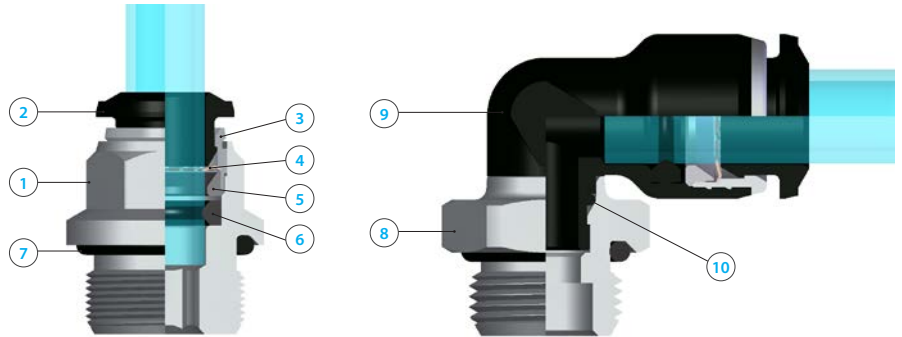

UNIVERSAL SHORT

La filettatura conica "UNIVERSAL SHORT" è progettata per soddisfare le seguenti caratteristiche:

- ridurre la lunghezza d'ingombro;
- ridurre la chiave rispetto ad alcuni raccordi con filettature cilindriche;
- consentire l'accoppiamento con diversi standard di filettature femmina sia coniche che cilindriche.

Consentire una completa tenuta anche su superfici non perfettamente piane, concave, convesse o inclinate, con diversi smussi o raggi.

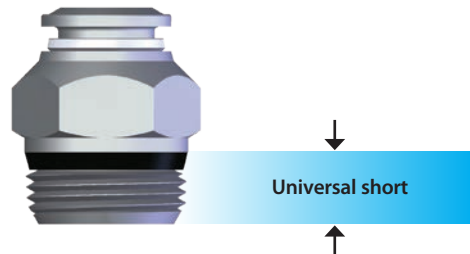

NPT Conica
NPTF



ISO 7 Cilindrica
BSPP



ISO 7 Conica
BSPT
PT



ISO 228 Cilindrica
BSP
PF

Inclinate



Concave



Convesso





Coppia di serraggio

I valori di rottura possono variare in base all'articolo

ISO 228

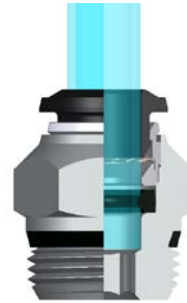
Misura	Coppia consigliata nm	Coppia di rottura nm
M5	0,8	3,2
M7	3	8
M8	3	8
1/8	3	8
1/4	9	30
3/8	10	60
1/2	12	50

"UNIVERSAL SHORT"

Misura	Coppia minima consigliata nm	Coppia massima consigliata nm
1/8	5	7
1/4	5	7
3/8	5	7
1/2	5	7

FLUIDO

Aria Compressa, Vuoto, Acqua

TEMPERATURA

 -20 °C
+80 °C

PRESSIONE

 - 0,99 bar (-0,099 MPa)
20 bar (2,0 MPa)

TUBI DI COLLEGAMENTO

Tubi in materiale plastico:

PA6, PA11, PA12, Polietilene, *Poliuretano, PTFE, FEP.

*Utilizzo da 90 a 98 Shore, per la massima prestazione è consigliato 98 Shore A.

FILETTATURA

Gas conica "UNIVERSAL SHORT".

Gas conica conforme ISO 7.1, BS 21, DIN 2999.

Gas cilindrica conforme ISO 228 Classe A.

Metrica conforme ISO R/262.

Vantaggi

1. La pinza in acciaio inox garantisce il perfetto aggraffaggio di tubi di qualsiasi materiale senza danneggiarne la superficie. Il collegamento tra tubo e raccordo assicura una tenuta totale anche in condizioni di urti e vibrazioni.
2. La particolare geometria della guarnizione permette inoltre l'utilizzo dei raccordi anche con il vuoto.
3. Tutte le filettature di questa serie sono state dotate di elementi di tenuta che permettono l'immediato utilizzo dei raccordi riducendo notevolmente i tempi di installazione.
4. Tutti i raccordi dritti possono essere montati anche con chiave esagonale ed è possibile utilizzarli anche in spazi molto ridotti.

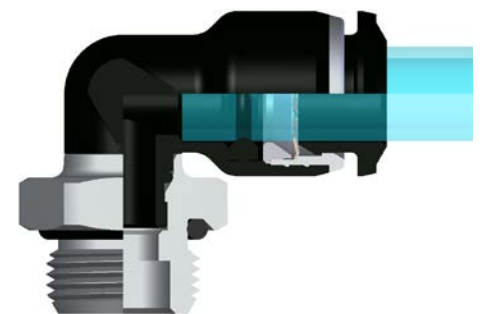
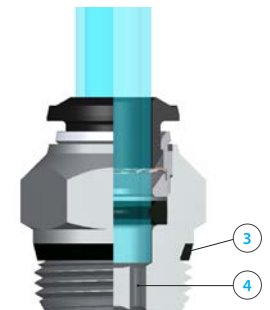
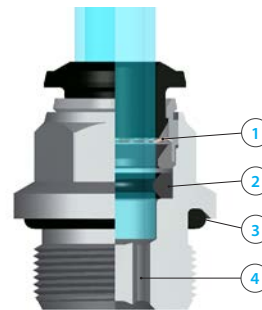

50020N

 RACCORDO DIRITTO MASCHIO
CILINDRICO

55000

 RACCORDO DIRITTO MASCHIO
"UNIVERSAL SHORT"

55010

 RACCORDO DIRITTO MASCHIO
ESAGONO INCASSATO

50010N

 RACCORDO DIRITTO MASCHIO
CILINDRICO ESAGONO
INCASSATO

50015N

 RACCORDO DIRITTO MASCHIO
CILINDRICO ESAGONO
INCASSATO

Tubo	Filetto	Code	Code	Code	Code	Code
3	M5	50020 00 N21	-	-	50010 00 N08	-
5/32 (4)	M3	50020 00 N34	-	-	-	-
5/32 (4)	M5	50020 00 N01	-	-	50010 00 N01	-
5/32 (4)	1/8	50020 00 N02	55000 00 001	55010 00 001	-	-
5/32 (4)	1/4	50020 00 N22	55000 00 013	-	-	-
5/32 (4)	3/8	50020 00 N41	-	-	-	-
5	M5	50020 00 N18	-	-	-	-
5	1/8	50020 00 N19	55000 00 002	-	-	-
5	1/4	50020 00 N36	55000 00 003	-	-	-
6	M5	50020 00 N20	-	-	50010 00 N07	-
6	1/8	50020 00 N03	55000 00 004	55010 00 002	-	50015 00 N03
6	1/4	50020 00 N04	55000 00 005	55010 00 003	-	-
6	3/8	50020 00 N27	55000 00 014	-	-	-
6	1/2	50020 00 N28	55000 00 015	-	-	-
5/16 (8)	1/8	50020 00 N05	55000 00 006	55010 00 004	-	50015 00 N04
5/16 (8)	1/4	50020 00 N06	55000 00 007	55010 00 005	-	-
5/16 (8)	3/8	50020 00 N07	55000 00 008	-	-	-
5/16 (8)	1/2	50020 00 N29	55000 00 016	-	-	-
10	1/8	50020 00 N30	-	-	-	-
10	1/4	50020 00 N08	55000 00 009	-	-	50015 00 N12
10	3/8	50020 00 N09	55000 00 010	-	-	-
10	1/2	50020 00 N31	55000 00 017	-	-	-
12	1/4	50020 00 N32	55000 00 011	-	-	-
12	3/8	50020 00 N11	55000 00 012	-	-	-
12	1/2	50020 00 N23	55000 00 018	-	-	-
14	3/8	50020 00 N24	55000 00 019	-	-	-
14	1/2	50020 00 N25	55000 00 020	-	-	-
16	3/8	50020 00 N42	55000 00 021	-	-	-
16	1/2	50020 00 N43	55000 00 022	-	-	-
5/32 (4)	M6X1	50020 00 N46	-	-	-	-
5/32 (4)	M7X1	-	-	-	50010 00 N09	-
5/32 (4)	M8X1	50020 00 N33	-	-	-	-
6	M6X1	-	-	-	50010 00 N11	-
6	M8X1	50020 00 N37	-	-	-	-
6	M10X1	50020 00 N38	-	-	-	-
6	M12X1	50020 00 N12	-	-	-	-
6	M12X1,25	50020 00 N13	-	-	-	-
6	M12X1,5	50020 00 N14	-	-	-	-
5/16 (8)	M8X1	50020 00 N39	-	-	-	-
5/16 (8)	M10X1	50020 00 N40	-	-	-	-
5/16 (8)	M12X1,5	50020 00 N17	-	-	-	-

50030N

RACCORDO DIRITTO FEMMINA

55116

 RACCORDO A L ORIENTABILE
MASCHIO CILINDRICO

55106

 RACCORDO A L ORIENTABILE
FEMMINA

55111

 RACCORDO A L ORIENTABILE
MASCHIO "UNIVERSAL SHORT"

55126

 RACCORDO A L ORIENTABILE
PROLUNGATO MASCHIO
CILINDRICO

Tubo	Filetto	Code	Code	Code	Code	Code
5/32 (4)	M3X0,5	50030 00 N07	55116 00 001	-	-	-
5/32 (4)	M5	50030 00 N08	55116 00 002	-	-	55126 00 002
5/32 (4)	M7X1	-	55116 00 003	-	-	-
5/32 (4)	1/8	50030 00 N01	55116 00 004	55106 00 001	55111 00 001	55126 00 004
5/32 (4)	1/4	50030 00 N09	55116 00 005	55106 00 002	55111 00 002	-
5/32 (4)	3/8	-	55116 00 006	-	-	-
5	M5	-	55116 00 007	-	-	-
5	1/8	50030 00 N06	55116 00 009	-	55111 00 003	-
6	M5	-	55116 00 011	-	-	55126 00 008
6	M7X1	-	-	-	-	55126 00 025
6	M7	-	55116 00 029	-	-	-
6	M10x1	-	55116 00 030	-	-	-
6	M12x1	-	55116 00 031	-	-	-
6	1/8	50030 00 N02	55116 00 013	55106 00 003	55111 00 004	55126 00 009
6	1/4	50030 00 N03	55116 00 014	55106 00 004	55111 00 005	55126 00 024
6	3/8	-	55116 00 015	-	55111 00 006	-
6	1/2	-	55116 00 016	-	55111 00 007	-
5/16 (8)	M10x1	-	55116 00 032	-	-	-
5/16 (8)	M12x1	-	55116 00 033	-	-	-
5/16 (8)	1/8	50030 00 N04	55116 00 017	55106 00 005	55111 00 008	55126 00 013
5/16 (8)	1/4	50030 00 N05	55116 00 018	55106 00 006	55111 00 009	55126 00 014
5/16 (8)	3/8	50030 00 N10	55116 00 019	55106 00 007	55111 00 010	55126 00 015
5/16 (8)	1/2	-	55116 00 020	-	55111 00 011	-
10	1/8	-	55116 00 034	-	-	-
10	1/4	50030 00 N11	55116 00 021	55106 00 008	55111 00 012	55126 00 016
10	3/8	50030 00 N12	55116 00 022	55106 00 009	55111 00 013	55126 00 017
10	1/2	50030 00 N13	55116 00 023	-	55111 00 014	55126 00 018
12	1/4	-	55116 00 024	-	55111 00 015	55126 00 019
12	3/8	50030 00 N14	55116 00 025	-	55111 00 016	55126 00 020
12	1/2	50030 00 N15	55116 00 026	-	55111 00 017	55126 00 021
14	3/8	-	55116 00 027	-	55111 00 018	-
14	1/2	-	55116 00 028	-	55111 00 019	-
16	3/8	50030 00 N16	55116 00 035	-	55111 00 020	-
16	1/2	50030 00 N17	55116 00 036	-	55111 00 021	-

55170

 RACCORDO ORIENTABILE A 45°
MASCHIO "UNIVERSAL SHORT"

55175

 RACCORDO ORIENTABILE A 45°
MASCHIO CILINDRICO

55211

 RACCORDO A T ORIENTABILE
MASCHIO "UNIVERSAL SHORT"

55216

 RACCORDO A T ORIENTABILE
MASCHIO CILINDRICO

55223

 RACCORDO A T ORIENTABILE MASCHIO
LATERALE "UNIVERSAL SHORT"

Tubo	Filetto	Code	Code	Code	Code	Code
5/32 (4)	M5	-	55175 00 002	-	55216 00 002	-
5/32 (4)	1/8	55170 00 001	55175 00 004	55211 00 001	55216 00 004	55223 00 001
5/32 (4)	1/4	-	-	55211 00 002	55216 00 005	55223 00 002
5	M5	-	-	-	55216 00 007	-
5	1/8	-	-	55211 00 003	55216 00 009	55223 00 003
6	M5	-	55175 00 011	-	55216 00 011	-
6	1/8	55170 00 004	55175 00 013	55211 00 004	55216 00 013	55223 00 004
6	1/4	55170 00 005	55175 00 014	55211 00 005	55216 00 014	55223 00 005
5/16 (8)	1/8	55170 00 008	55175 00 017	55211 00 008	55216 00 017	55223 00 008
5/16 (8)	1/4	55170 00 009	55175 00 018	55211 00 009	55216 00 018	55223 00 009
5/16 (8)	3/8	55170 00 010	55175 00 019	55211 00 010	55216 00 019	55223 00 010
10	1/4	55170 00 012	55175 00 021	55211 00 012	55216 00 021	55223 00 012
10	3/8	55170 00 013	55175 00 022	55211 00 013	55216 00 022	55223 00 013
10	1/2	55170 00 014	55175 00 023	55211 00 014	55216 00 023	55223 00 014
12	1/4	55170 00 015	55175 00 024	55211 00 015	55216 00 024	55223 00 015
12	3/8	55170 00 016	55175 00 025	55211 00 016	55216 00 025	55223 00 016
12	1/2	55170 00 017	55175 00 026	55211 00 017	55216 00 026	55223 00 017
14	3/8	-	-	55211 00 018	55216 00 027	55223 00 018
14	1/2	-	-	55211 00 019	55216 00 028	55223 00 019
16	3/8	-	-	55211 00 020	55216 00 029	-
16	1/2	-	-	55211 00 021	55216 00 030	-

55226

 RACCORDO A T ORIENTABILE
MASCHIO LATERALE CILINDRICO

55320

 RACCORDO A Y ORIENTABILE
MASCHIO "UNIVERSAL SHORT"

55325

 RACCORDO A Y ORIENTABILE
MASCHIO CILINDRICO

55340

 RACCORDO MULTIPLO A Y ORIENTABILE
MASCHIO "UNIVERSAL SHORT"

55345

 RACCORDO MULTIPLO A Y
ORIENTABILE MASCHIO CILINDRICO

Tubo	Filetto	Code	Code	Code	Code	Code
5/32 (4)	M5	55226 00 002	-	55325 00 002	-	-
5/32 (4)	M7X1	-	-	-	-	-
5/32 (4)	1/8	55226 00 004	55320 00 002	55325 00 003	55340 00 001	55345 00 001
5/32 (4)	1/4	55226 00 005	55320 00 007	55325 00 009	55340 00 002	55345 00 002
5	M5	55226 00 007	-	-	-	-
5	1/8	55226 00 009	-	-	-	-
6	M5	55226 00 011	-	55325 00 004	-	-
6	1/8	55226 00 013	55320 00 003	55325 00 005	55340 00 003	55345 00 003
6	1/4	55226 00 014	55320 00 004	55325 00 006	55340 00 004	55345 00 004
5/16 (8)	1/8	55226 00 017	55320 00 005	55325 00 007	-	-
5/16 (8)	1/4	55226 00 018	55320 00 006	55325 00 008	-	-
5/16 (8)	3/8	55226 00 019	55320 00 008	55325 00 010	-	-
10	1/4	55226 00 021	55320 00 009	55325 00 011	-	-
10	3/8	55226 00 022	55320 00 010	55325 00 012	-	-
10	1/2	55226 00 023	55320 00 011	55325 00 013	-	-
12	1/4	55226 00 024	-	-	-	-
12	3/8	55226 00 025	55320 00 012	55325 00 014	-	-
12	1/2	55226 00 026	55320 00 013	55325 00 015	-	-
14	3/8	55226 00 027	-	-	-	-
14	1/2	55226 00 028	-	-	-	-

55230

RACCORDO A T INTERMEDIO

55130

RACCORDO A L INTERMEDIO

55140

 RACCORDO A L CON CODA
LISCIA CORTA

55150

 RACCORDO A L CON CODA
LISCIA LUNGA

55160

 RACCORDO A 45° CON CODA
LISCIA CORTA

Tubo	Tubo	Code	Code	Code	Code	Code
5/32 (4)	5/32 (4)	55230 00 002	55130 00 002	55140 00 001	55150 00 001	55160 00 001
5/32 (4)	6	55230 00 019	-	55140 00 002	55150 00 002	-
5	5	55230 00 003	55130 00 003	-	-	-
6	6	55230 00 004	55130 00 004	55140 00 005	55150 00 005	55160 00 005
6	5/32 (4)	55230 00 009	-	55140 00 006	55150 00 006	-
6	5/16 (8)	55230 00 018	-	55140 00 012	-	-
5/16 (8)	5/16 (8)	55230 00 005	55130 00 005	55140 00 007	55150 00 007	55160 00 007
5/16 (8)	5/32 (4)	55230 00 021	-	-	-	-
5/16 (8)	6	55230 00 010	55130 00 009	-	-	-
5/16 (8)	10	55230 00 015	-	55140 00 008	55150 00 008	-
10	6	-	55130 00 012	-	-	-
10	10	55230 00 006	55130 00 006	55140 00 009	55150 00 009	55160 00 009
10	5/16 (8)	55230 00 011	55130 00 010	-	-	-
10	12	55230 00 017	-	55140 00 010	55150 00 010	-
12	12	55230 00 007	55130 00 007	55140 00 011	55150 00 011	55160 00 011
12	10	55230 00 012	55130 00 011	-	-	-
14	14	55230 00 008	55130 00 008	-	-	-
14	5/16 (8)	55230 00 016	-	-	-	-
14	10	55230 00 013	-	-	-	-
14	12	55230 00 014	-	-	-	-
16	16	55230 00 020	55130 00 013	-	-	-

55180

RACCORDO INTERMEDIO A 45°

55235

 RACCORDO A T CON
ADATTATORE LATERALE

55237

 RACCORDO A T CON
ADATTATORE CENTRALE

55240

 RACCORDO A T ORIENTABILE CON
CODA LISCIA CORTA

55310

RACCORDO A Y INTERMEDIO



Tubo	Tubo	Code	Code	Code	Code	Code
5/32 (4)	5/32 (4)	55180 00 002	55235 00 002	-	55240 00 001	55310 00 002
5/32 (4)	6	-	55235 00 009	-	55240 00 002	-
6	6	55180 00 004	55235 00 004	-	55240 00 005	55310 00 004
6	5/32 (4)	-	-	55237 00 009	55240 00 006	55310 00 008
6	5/16 (8)	-	55235 00 010	-	-	-
5/16 (8)	5/16 (8)	55180 00 005	55235 00 005	-	55240 00 007	55310 00 005
5/16 (8)	5/32 (4)	-	-	-	-	-
5/16 (8)	6	-	-	55237 00 010	-	55310 00 009
5/16 (8)	10	-	55235 00 011	-	55240 00 008	-
10	10	55180 00 006	55235 00 006	-	55240 00 009	55310 00 006
10	5/16 (8)	-	-	55237 00 011	-	55310 00 010
10	12	-	55235 00 012	-	55240 00 010	-
12	12	55180 00 007	55235 00 007	-	55240 00 011	55310 00 007
12	5/16 (8)	-	-	-	-	55310 00 011
12	10	-	-	55237 00 012	-	-

55360

RACCORDO MULTIPLIO DI RIDUZIONE ORIENTABILE MASCHIO "UNIVERSAL SHORT"



Tubo	Tubo	Filetto	Code
6	5/32(4)	1/8	55360 00 001
6	5/32(4)	1/4	55360 00 002
5/16(8)	5/32(4)	1/8	55360 00 003
5/16(8)	5/32(4)	1/4	55360 00 004
5/16(8)	6	1/8	55360 00 005
5/16(8)	6	1/4	55360 00 006
10-6	6	1/4	55360 00 007
10-6	6	3/8	55360 00 008
10	5/16(8)	1/4	55360 00 009
10	5/16(8)	3/8	55360 00 010

55365

RACCORDO MULTIPLIO DI RIDUZIONE ORIENTABILE MASCHIO CILINDRICO



Code
55365 00 001
55365 00 002
55365 00 003
55365 00 004
55365 00 005
55365 00 006
55365 00 007
55365 00 008
55365 00 009
55365 00 010

55500

ANELLO ORIENTABILE A L



Tubo	Filetto	Code
5/32 (4)	M5	55500 00 001
5/32 (4)	M6	55500 00 002
5/32 (4)	1/8	55500 00 003
5/32 (4)	1/4	55500 00 018
5	M5	55500 00 004
5	M6	55500 00 005
5	1/8	55500 00 006
5	1/4	55500 00 007
6	M5	55500 00 008
6	M6	55500 00 009
6	1/8	55500 00 010
6	1/4	55500 00 011
6	3/8	-
5/16 (8)	1/8	55500 00 012
5/16 (8)	1/4	55500 00 013
5/16 (8)	3/8	55500 00 014
10	1/4	55500 00 019
10	3/8	55500 00 015
12	3/8	55500 00 016
12	1/2	55500 00 017

55510

ANELLO ORIENTABILE A T



Code
55510 00 001
-
55510 00 003
-
-
-
55510 00 006
55510 00 007
-
-
-
55510 00 010
55510 00 011
-
55510 00 012
55510 00 013
-
-
-
-
-
-
-

55520

ANELLO ORIENTABILE A Y



Code
-
-
55520 00 001
55520 00 002
-
-
-
-
-
-
-
55520 00 003
55520 00 004
55520 00 005
-
55520 00 006
55520 00 007
-
55520 00 008
-
-

55410
 VITE CAVA SINGOLA

55420
 VITE CAVA DOPPIA

55430
 VITE CAVA TRIPLA

55440
 VITE CAVA SINGOLA MASCHIO – FEMMINA



Tubo	Code	Code	Code	Code
M5	55410 00 01 B5 NB	-	-	-
M6	55410 00 01 B8 NB	-	-	-
1/8	55410 00 01 02 NB	55420 00 01 02 NT	55430 00 01 02 NT	55440 00 01 02 NB
1/4	55410 00 01 03 NB	55420 00 01 03 NT	55430 00 01 03 NT	55440 00 01 03 NB
3/8	55410 00 01 04 NT	55420 00 01 04 NT	55430 00 01 04 NT	55440 00 01 04 NB
1/2	55410 00 01 05 NT	55420 00 01 05 NT	55430 00 01 05 NT	

ESEMPIO :
ESEMPI DI ASSEMBLAGGIO DELLE VITI CON ANELLI ORIENTABILI SINGOLI E DOPPI

Vite cava singola

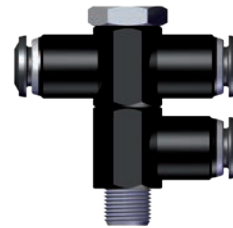

Vite cava doppia



Vite cava tripla

50900N

RIPARTITORE IN ALLUMINIO A 5 VI



Tubo	Filetto	Code
4	1/8	50900 00 001
6	1/8	50900 00 002
6	1/4	50900 00 003
8	1/4	50900 00 004

50600

ADATTATORE MASCHIO CILINDRICO



Tubo	Filetto	Code
4	M5	50600 00 001
4	1/8	50600 00 002
5	M5	50600 00 012
5	1/8	50600 00 013
5	1/4	50600 00 014
6	M5	50600 00 015
6	1/8	50600 00 003
6	1/4	50600 00 004
8	1/8	50600 00 005
8	1/4	50600 00 006
8	3/8	50600 00 007
10	1/8	50600 00 016
10	1/4	50600 00 008
10	3/8	50600 00 009
10	1/2	50600 00 017
12	1/4	50600 00 010
12	3/8	50600 00 011
14	1/2	50600 00 018

50610

TAPPO IN POLIAMIDE



Tubo	Code
3	50610 00 31 X0 RO
4	50610 00 31 X1 RO
5	50610 00 31 X3 RO
6	50610 00 31 X4 RO
8	50610 00 31 X7 RO
10	50610 00 31 X9 RO
12	50610 00 31 Y1 RO
14	50610 00 31 Y3 RO
16	50610 00 31 Y5 RO

55620

TAPPO TERMINALE



Tubo	Tubo	Code	Code
4	-	-	55625 00 31 X1 NE
6	-	-	55625 00 31 X4 NE
8	-	-	55625 00 31 X7 NE
10	-	-	55625 00 31 X9 NE
12	-	-	55625 00 31 Y1 NE
14	-	-	55625 00 31 Y3 NE
4	10	55620 00 002	-
6	12,5	55620 00 004	-
8	14	55620 00 005	-
10	17	55620 00 006	-
12	20	55620 00 007	-
14	21	55620 00 008	-

55625

GIUNZIONE DOPPIA

55700

RIDUZIONE



Tubo	Filetto	Code	Code
4	6	-	55705 00 001
6	4	55700 00 001	-
6	8	-	55705 00 002
8	4	55700 00 008	-
8	6	55700 00 002	-
8	10	-	55705 00 003
10	6	55700 00 011	-
10	8	55700 00 003	-
10	12	-	55705 00 004
12	6	55700 00 013	-
12	8	55700 00 007	-
12	10	55700 00 010	-
14	8	55700 00 014	-
14	10	55700 00 015	-
14	12	55700 00 012	-

55705

RIDUZIONE

50980

CLIP DI SICUREZZA



Tubo	Code
5/32 (4)	50980 00 32 X1 RO
1/4 (6)	50980 00 32 X4 RO
5/16 (8)	50980 00 32 X7 RO
3/8 (10)	50980 00 32 X9 RO
1/2 (12)	50980 00 32 Y1 RO

50990

LEVA SGANCIO ADATTATORI



Code
50990 00 001

LEGENDA

Regolazione a cacciavite



Regolazione manuale

REGOLATORI DI FLUSSO MINI
56900

REGOLATORE UNIDIREZIONALE ORIENTABILE PER CILINDRO FILETTO CILINDRICO

56910

REGOLATORE UNIDIREZIONALE ORIENTABILE PER VALVOLA FILETTO CILINDRICO

56920

REGOLATORE BIDIREZIONALE ORIENTABILE FILETTO CILINDRICO



Tubo	Filetto	Code	Code	Code
4	M5	56900 00 001	56910 00 001	56920 00 001
6	M5	56900 00 002	56910 00 002	56920 00 002

56935

REGOLATORE UNIDIREZIONALE ORIENTABILE PER CILINDRO FILETTO CILINDRICO

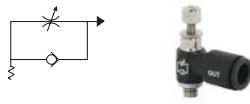
56945

REGOLATORE UNIDIREZIONALE ORIENTABILE PER VALVOLA FILETTO CILINDRICO

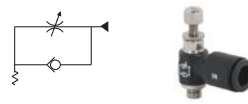
56955

REGOLATORE BIDIREZIONALE ORIENTABILE FILETTO CILINDRICO



Tubo	Filetto	Code	Code	Code
4	M3	56935 00 006	-	-
4	M5	56935 00 001	56945 00 001	56955 00 001
4	1/8	56935 00 003	56945 00 003	56955 00 003
6	M5	56935 00 002	-	56955 00 002
6	1/8	56935 00 004	56945 00 004	56955 00 004

REGOLATORI DI FLUSSO
55902

REGOLATORE UNIDIREZIONALE ORIENTABILE PER CILINDRO FILETTO CILINDRICO, REGOLAZIONE A CACCIAVITE

55912

REGOLATORE UNIDIREZIONALE ORIENTABILE PER VALVOLA FILETTO CILINDRICO, REGOLAZIONE A CACCIAVITE

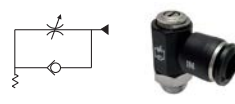
55922

REGOLATORE BIDIREZIONALE ORIENTABILE FILETTO CILINDRICO, REGOLAZIONE A CACCIAVITE



Tubo	Filetto	Code	Code	Code
4	1/8	55902 00 003	55912 00 003	55922 00 003
6	1/8	55902 00 008	55912 00 008	55922 00 008
6	1/4	55902 00 009	55912 00 009	55922 00 009
8	1/8	55902 00 010	55912 00 010	55922 00 010
8	1/4	55902 00 011	55912 00 011	55922 00 011
8	3/8	55902 00 012	55912 00 012	55922 00 012
10	1/4	55902 00 016	55912 00 016	55922 00 016
10	3/8	55902 00 013	55912 00 013	55922 00 013
12	3/8	55902 00 014	55912 00 014	55922 00 014
12	1/2	55902 00 015	55912 00 015	55922 00 015

55906

REGOLATORE UNIDIREZIONALE ORIENTABILE PER CILINDRO FILETTO CILINDRICO, REGOLAZIONE MANUALE



55916

REGOLATORE UNIDIREZIONALE ORIENTABILE PER VALVOLA FILETTO CILINDRICO, REGOLAZIONE MANUALE



55926

REGOLATORE BIDIREZIONALE ORIENTABILE FILETTO CILINDRICO, REGOLAZIONE MANUALE



Tubo	Filetto	Code
6	1/4	55906 00 009
8	1/8	55906 00 010
8	1/4	55906 00 011
8	3/8	55906 00 012
10	1/4	55906 00 016
10	3/8	55906 00 013
12	3/8	55906 00 014
12	1/2	55906 00 015

Tubo	Filetto	Code
6	1/4	55916 00 009
8	1/8	55916 00 010
8	1/4	55916 00 011
8	3/8	55916 00 012
10	1/4	55916 00 016
10	3/8	55916 00 013
12	3/8	55916 00 014
12	1/2	55916 00 015

Tubo	Filetto	Code
6	1/4	55926 00 009
8	1/8	55926 00 010
8	1/4	55926 00 011
8	3/8	55926 00 012
10	1/4	55926 00 016
10	3/8	55926 00 013
12	3/8	55926 00 014
12	1/2	55926 00 015

REGOLATORI DI FLUSSO IN LINEA

55940

REGOLATORE IN LINEA UNIDIREZIONALE TUBO - TUBO



55945

REGOLATORE IN LINEA UNIDIREZIONALE PER CILINDRO MASCHIO "UNIVERSAL SHORT" - TUBO



55950

REGOLATORE IN LINEA UNIDIREZIONALE PER VALVOLA TUBO - MASCHIO "UNIVERSAL SHORT"



55955

REGOLATORE IN LINEA BIDIREZIONALE TUBO-TUBO



55960

REGOLATORE IN LINEA BIDIREZIONALE MASCHIO "UNIVERSAL SHORT" - TUBO



Tubo	Filetto	Code
4	-	55940 00 004
6	-	55940 00 001
8	-	55940 00 002
10	-	55940 00 003
4	1/8	-
6	1/8	-
6	1/4	-
8	1/4	-
8	3/8	-
10	3/8	-
10	1/2	-

Code
-
-
-
-
55945 00 007
55945 00 001
55945 00 002
55945 00 003
55945 00 004
55945 00 005
55945 00 006

Code
-
-
-
-
55950 00 007
55950 00 001
55950 00 002
55950 00 003
55950 00 004
55950 00 005
55950 00 006

Code
55955 00 004
55955 00 001
55955 00 002
55955 00 003
-
-
-
-
-
-
-
-

Code
-
-
-
-
55960 00 007
55960 00 001
55960 00 002
55960 00 003
55960 00 004
55960 00 005
55960 00 006

55970

REGOLATORE DI PRESSIONE IN LINEA TUBO-TUBO

55975

 REGOLATORE DI PRESSIONE IN LINEA TUBO - MASCHIO
 "UNIVERSAL SHORT"

55980

 REGOLATORE DI PRESSIONE IN LINEA MASCHIO
 "UNIVERSAL SHORT" - TUBO

Tubo	Filetto	Code	Code	Code
6	-	55970 00 002	-	-
8	-	55970 00 003	-	-
10	-	-	-	-
4	1/8	-	-	-
6	1/8	-	55975 00 001	55980 00 001
6	1/4	-	55975 00 002	55980 00 002
8	1/4	-	55975 00 003	55980 00 003
8	3/8	-	55975 00 004	55980 00 004
8	3/8	-	55945 00 004	55960 00 004
10	3/8	-	55945 00 005	55960 00 005
10	1/2	-	55945 00 006	55960 00 006