

Pivot rotation in degrees	A
45°	632.5
60°	648.5
90°	685.5
120°	724.5

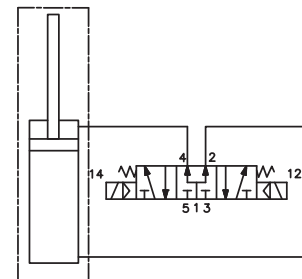
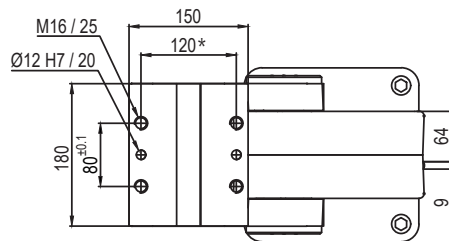

UAGP605OK__WSO

6 PIVOT ROTATION

6

120 = 120°
 090 = 90°
 060 = 60°
 045 = 45°

Size	Holding moment	Max. torque at the rotary table 0,55 MPa	Weight
605	8000 Nm	600 Nm	54 Kg

Min./Max. operating pressure: **0,4 / 0,6 MPa**
 Operating temperature: **5° ÷ 45° C**
 Predetermine pivot rotation in degrees: **45°- 60°- 90°- 120°**
 Rotary table position: **Horizontal 90°**
 Electronic sensor with M12 swivel connector, from 0° to 90°
 Supply voltage: **10 ÷ 30 Vdc**
 IP code: **IP 65**

* : TOLERANCE BETWEEN DOWEL HOLES ± 0,02, BETWEEN SCREW HOLES ± 0,1

Subject to technical modifications without notice

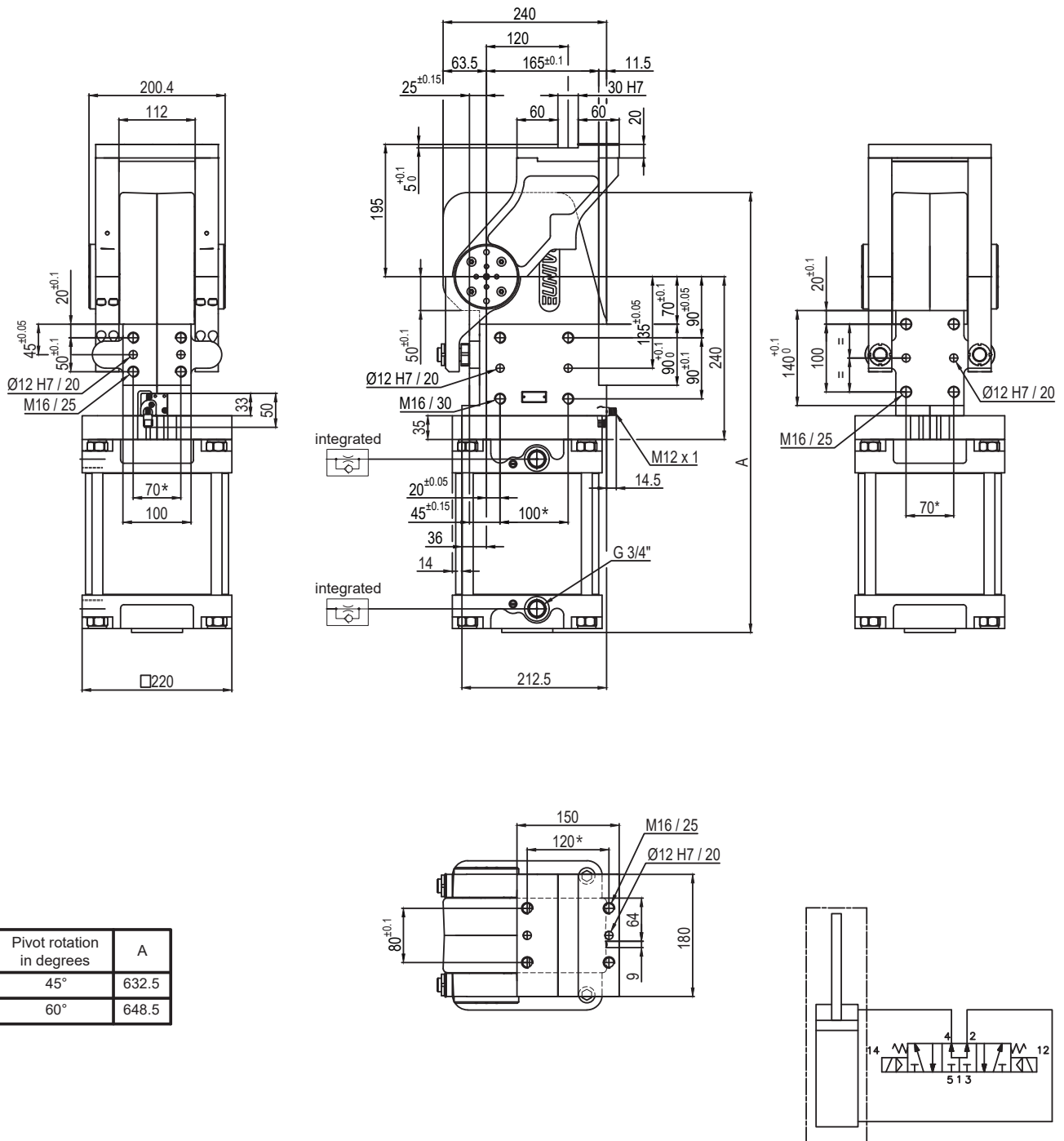

Pivot rotation in degrees	A
45°	632.5
60°	648.5

UAGP605PK__WSO

6 PIVOT ROTATION

6

060 = 60°
045 = 45°

Size	Holding moment	Max. torque at the rotary table 0,55 MPa	Weight
605	8000 Nm	600 Nm	54 Kg

Min./Max. operating pressure: **0,4 / 0,6 MPa**
 Operating temperature: **5° ÷ 45° C**
 Predetermine pivot rotation in degrees: **45° - 60°**
 Rotary table position: **Horizontal mirror of O**
 Electronic sensor with M12 swivel connector, from 0° to 90°
 Supply voltage: **10 ÷ 30 Vdc**
 IP code: **IP 65**

*: TOLERANCE BETWEEN DOWEL HOLES ± 0,02, BETWEEN SCREW HOLES ± 0,1

Subject to technical modifications without notice

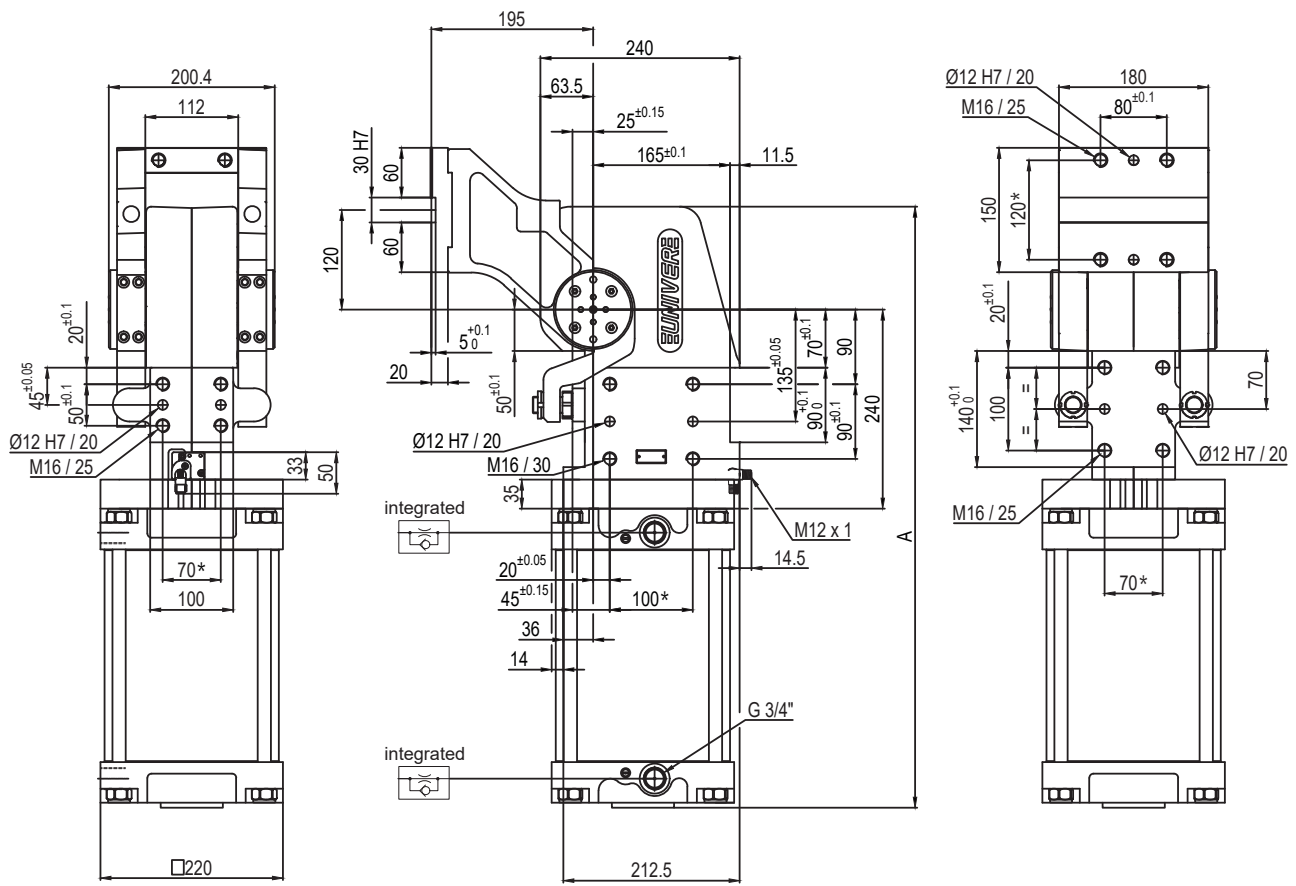

Pivot rotation in degrees	A
45°	632.5
60°	648.5
90°	685.5
120°	724.5

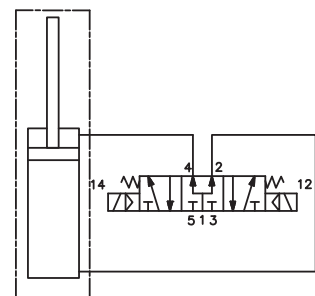
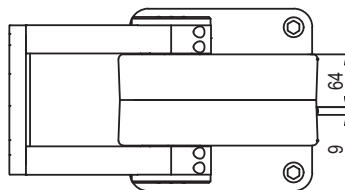
UAGP605VK__WS0
6 PIVOT ROTATION
6

120 = 120°
 090 = 90°
 060 = 60°
 045 = 45°

Size	Holding moment	Max. torque at the rotary table 0,55 MPa	Weight
605	8000 Nm	600 Nm	54 Kg

Min./Max. operating pressure: **0,4 / 0,6 MPa**
 Operating temperature: **5° ÷ 45° C**
 Predetermine pivot rotation in degrees: **45° - 60° - 90° - 120°**
 Rotary table position: **Vertical 180°**
 Electronic sensor with M12 swivel connector, from 0° to 90°
 Supply voltage: **10 ÷ 30 Vdc**
 IP code: **IP 65**

*: TOLERANCE BETWEEN DOWEL HOLES ± 0,02, BETWEEN SCREW HOLES ± 0,1

Subject to technical modifications without notice

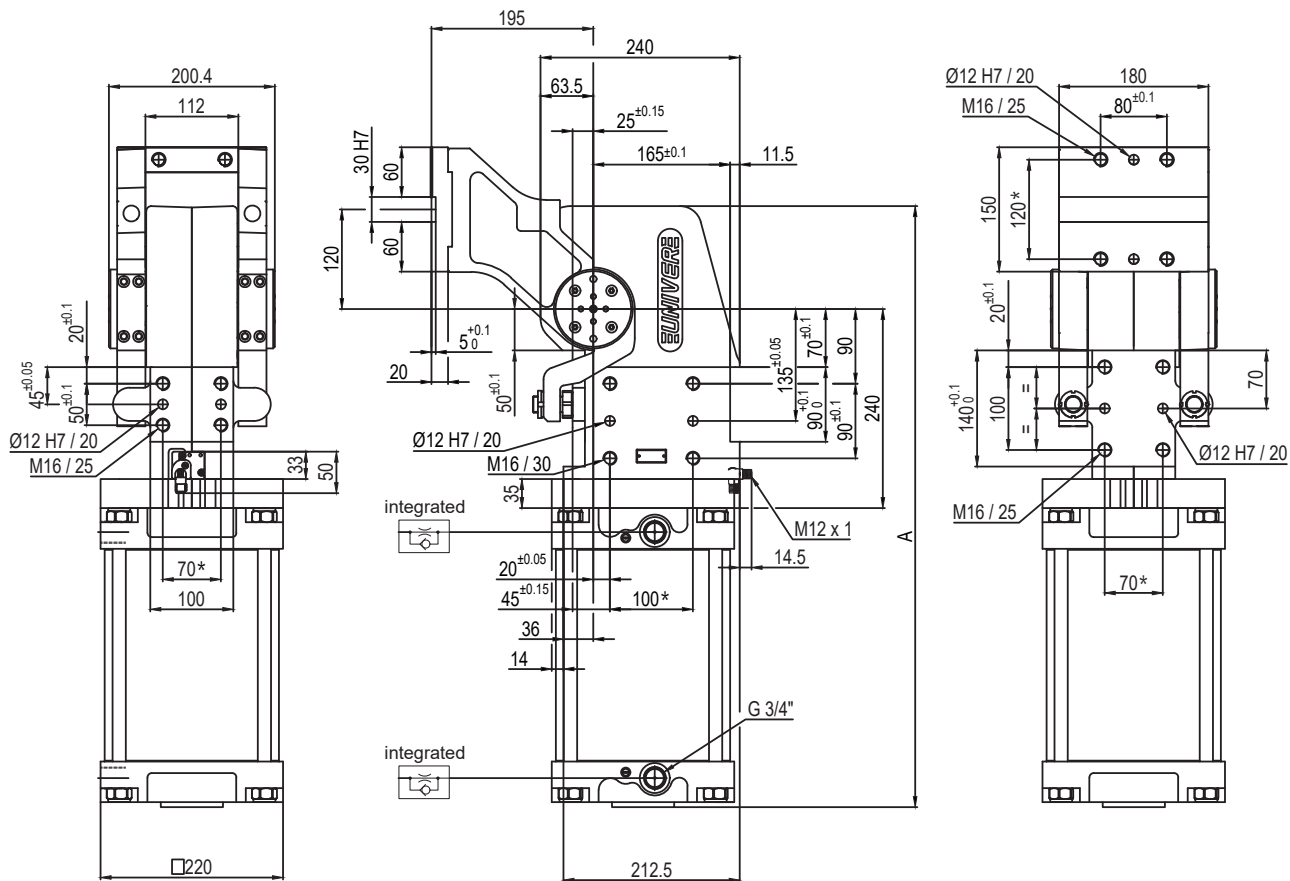

Pivot rotation in degrees	A
45°	632.5
60°	648.5
90°	685.5
120°	724.5

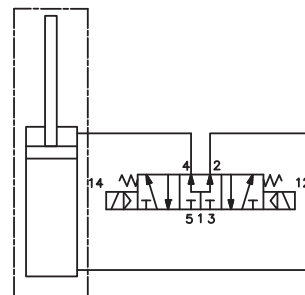
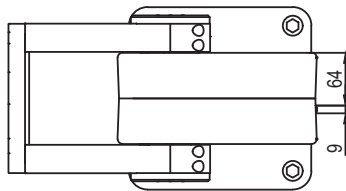
UAGP605ZK__WS0
6 PIVOT ROTATION
6

120 = 120°
 090 = 90°
 060 = 60°
 045 = 45°

Size	Holding moment	Max. torque at the rotary table 0,55 MPa	Weight
605	8000 Nm	600 Nm	54 Kg

Min./Max. operating pressure: **0,4 / 0,6 MPa**
 Operating temperature: **5° ÷ 45° C**
 Predetermine pivot rotation in degrees: **45° - 60° - 90° - 120°**
 Rotary table position: **Vertical, mirror of V**
 Electronic sensor with M12 swivel connector, from 0° to 90°
 Supply voltage: **10 ÷ 30 Vdc**
 IP code: **IP 65**

*: TOLERANCE BETWEEN DOWEL HOLES ± 0,02, BETWEEN SCREW HOLES ± 0,1

Subject to technical modifications without notice