

TC and TE Fieldbus Modules



- Industrial standard connections M8 or M12.
- Integrated connections with ISO VDMA manifolds and compact valves 10/15/22 mm.
- Integrated 24 coils controls for TC version only.
- Expansion capability till 64 digital inputs or 88 digital outputs according to the model.
- Visual diagnostic with LED screen and through fieldbus.
- IP65 protection degree.
- Separate logic power supply of input and outputs, so that it is possible to cut off the outputs only.

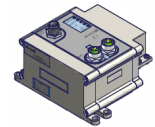
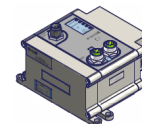

TABLE OF CONTENTS

Important information	4
Definitions	4
Symbol Legend	5
Description of the modular system.....	5
Codification key	6
Installation.....	7
TCxPN and TExPN modules - Profinet	8
TCxEN and TExEN modules - EtherNet/IP	9
TCxEC and TExEC modules - EtherCAT	10
TCxP and TExP modules - Profibus	11
TCxC and TExC modules - CANopen.....	12
TCxLKA and TCxLKB modules - IO-Link	13
M12 connectors pinout for Profinet, EtherNet/IP, EtherCAT modules.....	14
M12 connectors pinout for Profibus modules	15
M12 connectors pinout for CANopen modules	16
M12 connectors pinout for IO-Link modules.....	17
Power supply connections for Profinet, EtherNet/IP, EtherCAT modules.....	18
Power supply connections for Profibus, CANopen modules.....	19
Connection to the Profinet, EtherNet/IP, EtherCAT fieldbus network.....	20
Connection to the Profibus fieldbus network	21
Profibus network termination.....	21
Connection to the CANopen Fieldbus.....	22
CANopen network termination.....	22
How to set Profinet, EtherNet/IP, EtherCAT network address.....	23
How to set Profibus network address.....	26
How to set the CANopen network address.....	26
Coils, inputs and outputs addressing	27
Product identification label	28
Allocation of manifold valve Byte/Bit	29
Allocation of Byte/Bit of further output modules	29
Allocation of Byte/Bit of further input modules	29
Allocation of Byte/Bit of electric clamp modules	30
Auxiliary input and output modules.....	31
Auxiliary input and output modules (features)	32
Supply and separator modules.....	33
Supply and separator modules (features)	34
Modules for electric power clamps.....	35
Modules for electric clamps (features)	36
Accessories for serial modules	38
Accessories for clamping device modules.....	39
Connection cables for clamping device modules.....	39
Connection cables for remote modules.....	40
LED Status and Diagnostics - Profinet.....	41
Status and Diagnostics - EtherNet/IP LED	42
LED Status and Diagnostics - EtherCAT.....	43
Error codes - Profinet, EtherNet/IP, EtherCAT	44
LED Status and Diagnostics - Profibus	45
LED Status and Diagnostics - CANopen.....	45
Error codes - Profibus and CANopen.....	46
LED Status and Diagnostics - IO-Link.....	47
Error codes Table - IO-Link	47
Configuration Parameters - Profinet	48
Error codes of the Profinet diagnostics messaging.....	52
Configuration Parameters - EtherNet/IP.....	53
Error codes of the EtherNet/IP diagnostics messaging.....	60
Configuration parameters - EtherCAT.....	61
Error codes of the EtherCAT diagnostics messaging.....	66
Configuration parameters - Profibus	68
Error codes in the Profibus diagnostics messaging	71
Configuration parameters - CANOPEN.....	72
Error codes in the CANopen diagnostics messages.....	73
Configuration Parameters - IO-Link	75
Module assembly system.....	76
Possible configuration examples	77
Damages caused by improper use	79
Correct and incorrect use.....	79
Scheduled maintenance frequency.....	79





Every action was intended to guarantee the accuracy and completeness of this document. However, we cannot completely exclude that there might be mistakes, therefore we will appreciate any kind of notification.

/ ----- /

We would like to highlight that hardware and software terms, as well as trademarks used or mentioned in this manual are usually registered trademarks or patents.

Note: all information can be changed without prior notice.

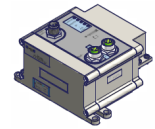

Important information

To guarantee a quick installation and set up of the device described in this manual, we highly recommend that the following information and explanations are carefully read and observed.

Qualified Personnel

The usage of the products described in this manual, are addressed exclusively to qualified personnel in the PLC programming, electrical specialists or people who act in place of specialized electricians and who are familiar with the existing rules. UNIVER S.p.A. declines any responsibilities resulting from improper actions and damages caused by the non-compliance to the prescriptions contained in this manual.

Designated use

For each single application, the supplied components must work with the appropriate Hardware and Software configuration. Adjustments are allowed only for the possibilities explained in this manual.

Every change to the Hardware and/or Software and/or the not compliant use of the components entails automatically the exclusion of liability by UNIVER S.p.A. and loss of the guarantee.

For specific requests and/or configuration consult UNIVER S.p.A

Safety notes

Attention. Remove all supplies and wait for at least 1 minute before working on the device and its modules.

In case of bended contacts, the affected module must be replaced, because its long- term functionality may be compromised.

ESD (electrostatic charges)

The modules have electronic components that may be damaged by electrostatic charges.

When working with the modules, make sure that the environment (people, workstation, packages) are well grounded or antistatic.

Avoid touching metal parts such as gold connections

Do not supply the devices with voltage outside of the indicated range.

Remember to connect the ground to the device, since some internal protections need such a connection to operate correctly.

No connection to the ground could damage the device.

Definitions

DI	Digital input
DO	Digital output
I/O	Input/Output
HW	Hardware
SW	Software
LSB	Less significant Byte
MSD	Most significant Byte

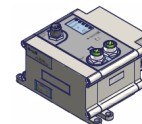

Symbol Legend

		Important NOTICE
		Attention Danger
		Additional information
		Recycle / Eco compatible materials

Description of the modular system

TC and TE series are slave devices for fieldbus to control of valves, digital inputs and outputs.

The system structure taken as an example below consists of the interface module for the valve manifold (1) and already included in the TC, the communication field module (2), (DeviceNet, CANopen, Profibus, Profinet, EtherNet/IP, EtherCAT), the digital input module (3), the digital output module (4), and the end cover (5).

Since this is a modular system, other modules can be added

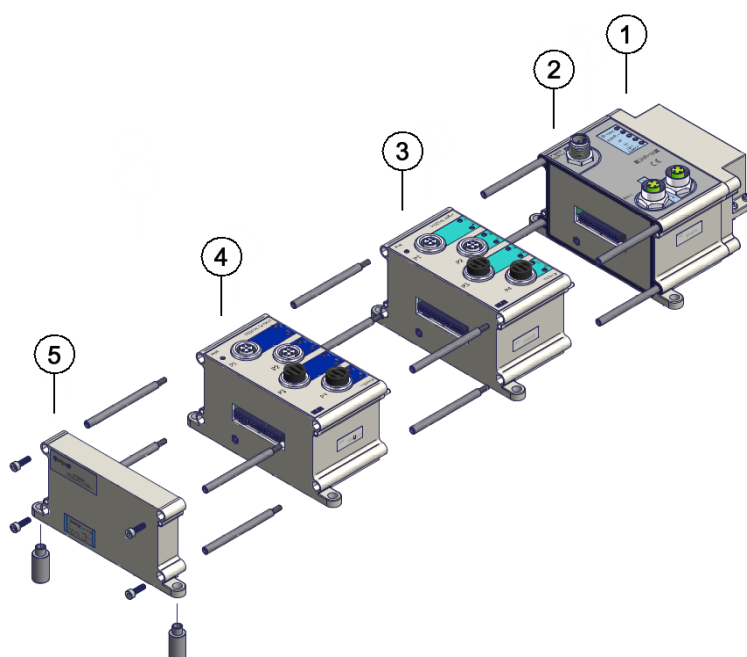

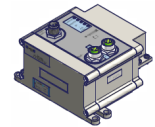

Codification key

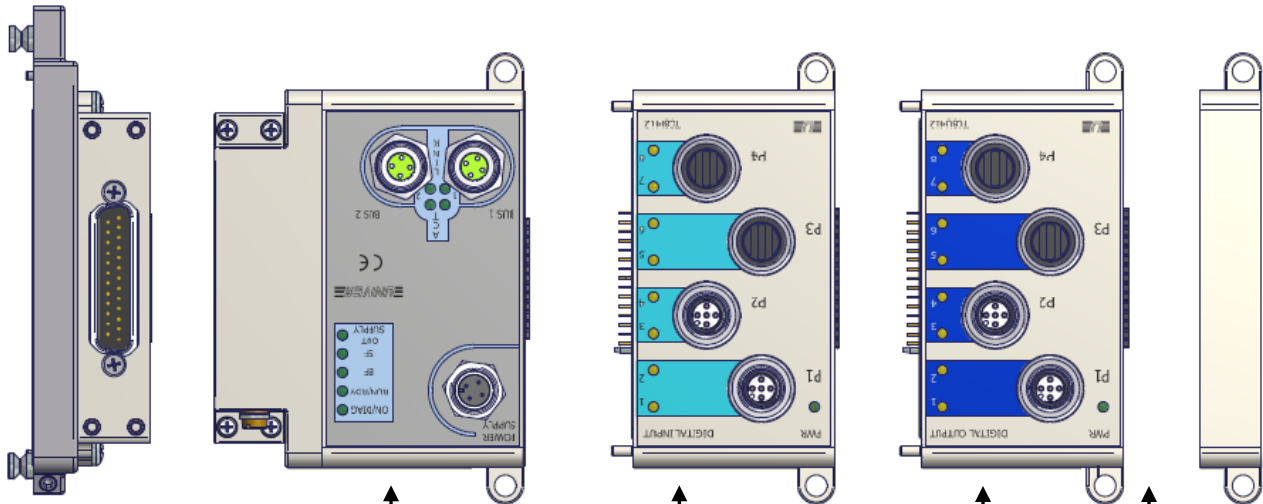

TC x EN 08 S 08

SERIES	
TC	I/O Module + Valve interface
TE	I/O Module

x	Standard connection M12
7	Auxiliary connection 7/8 (2)
M	Multibus connection M23 (1)

FIELDBUS	
C	CANopen 64+64 I/O
D	Devicenet 64+64 I/O
P	Profibus DP 64+64 I/O
PN	Profinet 64+88 I/O
EN	EtherNet/IP 64+88 I/O
EC	EtherCAT 64+88 I/O
LKA	IO-Link Class A 24 Coils
LKB	IO-Link Class B 24 Coils

DIGITAL INPUTS	
	no input module = 00
N° 00-08-16-24-32-40-48-56-64	

Input connector dimension	
S	M12 Standard digital input (4x2)
H	M12 High-Density digital input (TC16I812 8x2)
H2	M12 High-Density digital input (TC16I812-2F 8x2) support 2-wires electronic
8	M08 digital input (8x1)
	Blank if there is only the expansion module

DIGITAL OUTPUTS	
	no output module = 00
N° 00-08-16-24-32-40-48-56-64	

EXPANSIONS Digital inputs and outputs	
	Blank with no expansion module
32IN	1 Module TCR32ID 16+16 digital inputs (2xDSUB 25)
64IN	2 Modules TCR32ID 16+16 digital inputs (2xDSUB 25)
32UD	1 Module TCR32UD 16+16 digital outputs (2xDSUB 25)
64UD	2 Modules TCR32UD 16+16 digital outputs (2xDSUB 25)
1616	1 Module TCR1616 16 digital inputs + 16 digital outputs (2xDSUB 25) (3)
3232	1 Module TCR32ID + 1 Module TCR32UD
6464	2 Modules TCR32ID + 2 Modules TCR32UD
A1C	1 Module TC-ECSM + 1 Module TC-2ECD for 2 Electric Power Clammps
A2C	1 Module TC-ECSM + 2 Modules TC-2ECD for 4 Electric Power Clammps

- (1) Only for DeviceNet and Profibus.
- (2) This solution consists of an additional module (TCxUS78) equipped with 7/8 connectors (the POWER SUPPLY connector of the standard module is removed)
- (3) From 2022 no longer available.

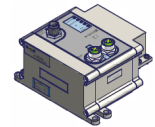

Installation

Before installing the device, be sure that it was not damaged during transport. Pay attention to the dimensions.

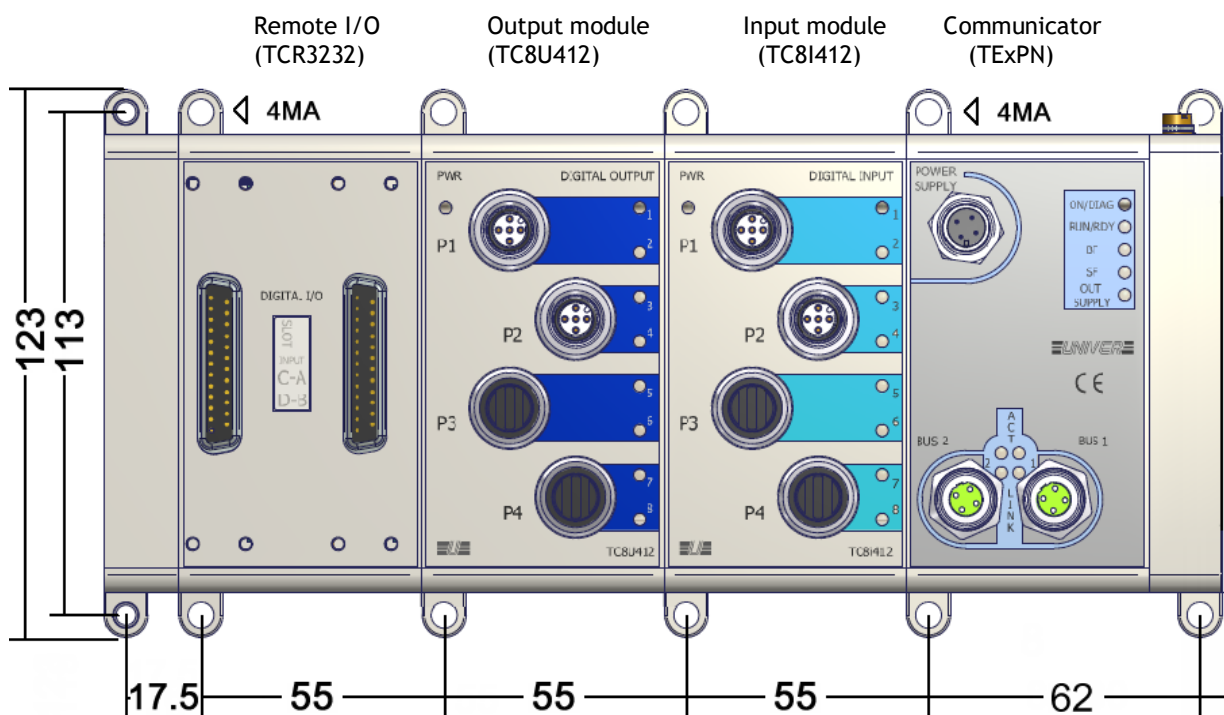
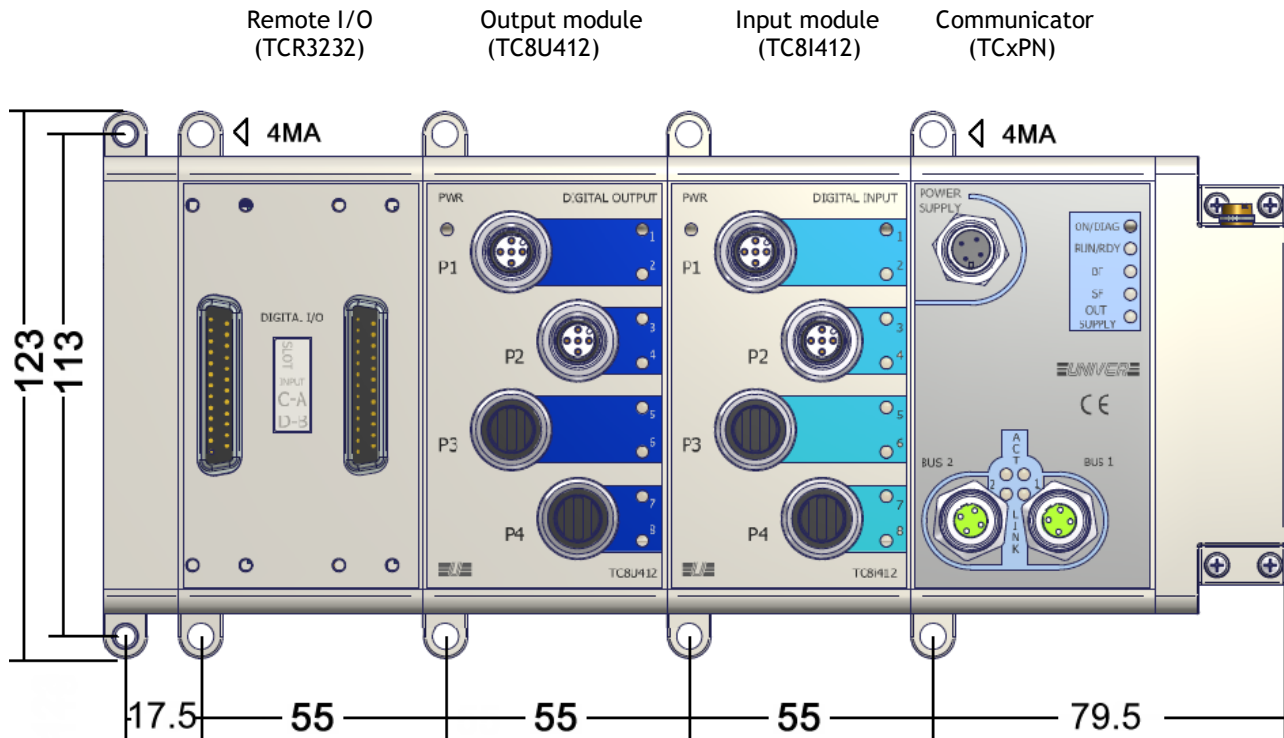

We recommend to fix the device through the proper holes with M4 screws.

The total length changes in accordance to the number of installed modules and according to the assembled valve manifold.

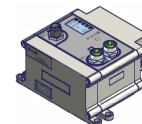

TCxPN and TExPN modules - Profinet

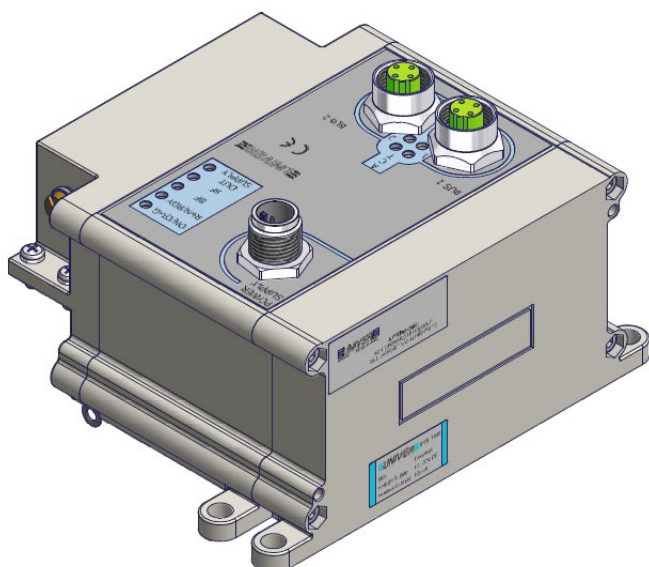

Fieldbus data		PROFINET IO	
Bus 1 and Bus 2 connectors	Circular M12 Female 4 pin D code 10Base-T/100Base-TX, Half/Full Duplex Auto Crossover Function; Auto-Negotiation RT Support FSU Support		
System LEDs	ON/DIAG	Green/Red	
	RUN/RDY	Green/Red	
Auxiliary LEDs	Out Supply	Green	
BUS LED	BF	Red	
	SF	Red	
	LINK 1 2	Green	
	ACT 1 2	Yellow	
Electrical data			
Connector Power Supply	Circular M12 male 4 pin A code		
Logic voltage / digital inputs (VLS24)	24 Vdc ± 15%		
Nominal power	150mA (TCxPN) 110mA(TExPN)		
Maximal power for digital inputs	1,5A @ 20 °C - overload protection		
Manifolds/outputs voltage (VA24)	24 Vdc -10% +15% (valves limit)		
Maximal power for all outputs (VA24)	2,5A max - overload protection		
Manageable outputs for valve manifolds	24 max coils - (12 bistable valves - 1,5A for 12 coils)		
Manageable auxiliary digital outputs	64 digital outputs (88 total outputs with 24 manifold coils)		
Manageable auxiliary digital inputs	64 digital inputs		
Environmental conditions			
Weight	TCxPN/TExPN	290g/260g	
Module overall dimensions	100x123x75 mm / 90x123x75 mm		
Protection degree	IP 65 (with connectors)	IEC 60529	
Relative humidity	5 to 85%	IEC 60068-2-30	
Operating temperature	5 °C ÷ 50 °C	IEC 60068-2-1	
Storage temperature	-25 °C ÷ 80 °C	IEC 60068-2-2	
Vibrations	5g tested 10-500Hz	IEC 60068-2-6	
Shock	22g	IEC 60068-2-27	

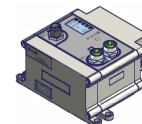

TCxEN and TExEN modules - EtherNet/IP

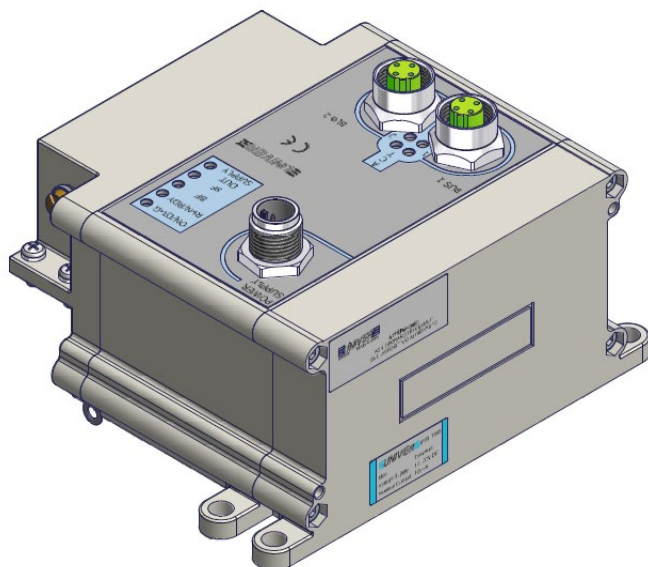

Fieldbus data		EtherNet/IP	
Bus 1 and Bus 2 connectors	Circular M12 Female 4 pin D code 10Base-T / 100Base-TX, Half/Full Duplex Auto Crossover Function; Auto-Negotiation		
System LEDs	ON/DIAG	Green/Red	
	RUN/RDY	Green/Red	
Auxiliary LEDs	Out Supply	Green	
BUS LED	MS	Green/Red	
	NS	Green/Red	
	LINK 1 2	Green	
	ACT 1 2	Yellow	
Electrical data			
Connector Power Supply	Circular M12 male 4 pin A code		
Logic voltage / digital inputs (VLS24)	24 Vdc ± 15%		
Nominal power	150mA (TCxEN) 110mA (TExEN)		
Maximal power for digital inputs	1,5A @ 20 °C - overload protection		
Manifolds/outputs voltage (VA24)	24 Vdc -10% +15% (valves limit)		
Maximal power for all outputs (VA24)	2,5A max - overload protection		
Manageable outputs for valve manifolds	24 max coils - (12 bistable valves - 1,5A for 12 coils)		
Manageable auxiliary digital outputs	64 digital outputs (88 total outputs with 24 manifold coils)		
Manageable auxiliary digital inputs	64 digital inputs		
Environmental conditions			
Weight	TCxEN/TExEN	290g/260g	
Module overall dimensions	100x123x75 mm / 90x123x75 mm		
Protection degree	IP 65 (with connectors)	IEC 60529	
Relative humidity	5 to 85%	IEC 60068-2-30	
Operating temperature	5 °C ÷ 50 °C	IEC 60068-2-1	
Storage temperature	-25 °C ÷ 80 °C	IEC 60068-2-2	
Vibrations	5g tested 10-500Hz	IEC 60068-2-6	
Shock	22g	IEC 60068-2-27	



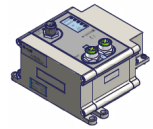

TCxEC and TExEC modules - EtherCAT

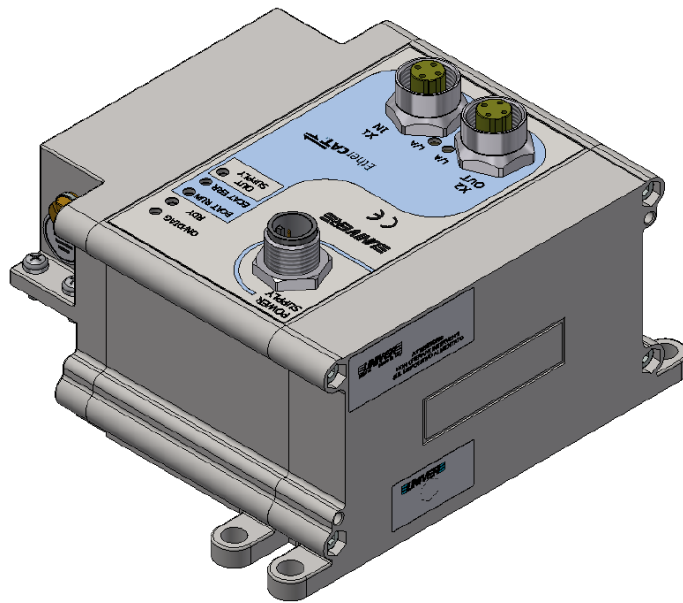

Fieldbus data		EtherCAT	
Connectors X1 IN e X2 OUT	Circular M12 Female 4 pin D code 10Base-T / 100Base-TX, Half/Full Duplex Auto Crossover Function; Auto-Negotiation		
System LED	ON/DIAG	Green/Red	
	RUN/RDY	Green/Red	
Auxiliary LEDs	Out Supply	Green	
BUS LED	ECAT RUN	Green	
	ECAT ERR	Red	
	L/A IN	Green	
	L/A OUT	Green	
Electrical data			
Connector power supply	Circular M12 male 4 pin A code		
Logic voltage / digital inputs (VLS24)	24 Vdc ± 15%		
Nominal power	150mA (TCxEC) 110mA (TExEC)		
Maximal power for digital inputs	1,5A @ 20 °C - overload protection		
Manifolds/outputs voltage (VA24)	24 Vdc -10% +15% (valves limit)		
Maximal power for all outputs (VA24)	2,5A max - overload protection		
Manageable outputs for valve manifolds	24 max coils - (12 bistable valves - 1,5A for 12 coils)		
Manageable auxiliary digital outputs	64 digital outputs (88 total outputs with 24 manifold coils)		
Manageable auxiliary digital inputs	64 digital inputs		
Environmental conditions			
Weight	TCxEC/TExEC	290g/260g	
Module overall dimensions	100x123x75 mm / 90x123x75 mm		
Protection degree	IP 65 (with connectors)		IEC 60529
Relative humidity	5 to 85%		IEC 60068-2-30
Operating temperature	5 °C ÷ 50 °C		IEC 60068-2-1
Storage temperature	-25 °C ÷ 80 °C		IEC 60068-2-2
Vibrations	5g tested 10-500Hz		IEC 60068-2-6
Shock	22g		IEC 60068-2-27



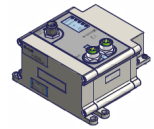

TCxP and TExP modules - Profibus

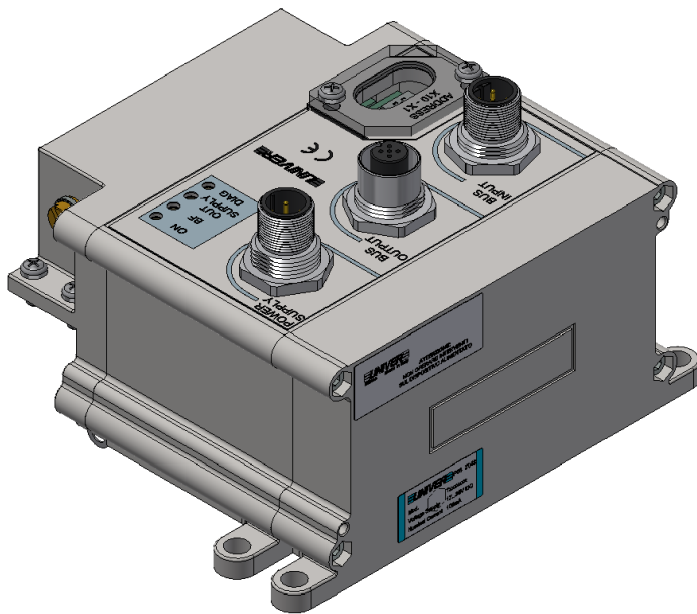

Fieldbus data		DP Profibus	
Input Bus connector	Circular M12 Male 4 pin B code		
Output Bus connector	Circular M12 Female 4 pin B code		
System LEDs	ON	Green	
	DIAG	Red	
Auxiliary LEDs	OUT SUPPLY	Green	
BUS LED	BF	Red	
Selectable Slave Adress	Selectable from 00 to 99		
Commutation speed	9.6Kbaud to 12Mbaud (AutoBode)		
Electrical data			
Connector power supply	Circular M12 male 4 pin A code		
Logic voltage / digital inputs (VLS24)	24 Vdc \pm 15%		
Nominal power	120mA (TCxP) 90mA (TExP)		
Maximal power for digital inputs	1,5A @ 20°C - overload protection		
Manifolds/outputs voltage (VA24)	24 Vdc -10% +15% (valves limit)		
Maximal power for all outputs (VA24)	2,5A max - overload protection		
Manageable outputs for valve manifolds	24 max coils - (12 bistable valves - 1,5A for 12 coils)		
Manageable auxiliary digital outputs	40 digital outputs (64 total outputs with 24 manifold coils)		
Manageable auxiliary digital inputs	64 digital inputs		
Environmental conditions			
Weight	TCxP/TExP	370g/280g	
Module overall dimensions	100x123x75 mm / 90x123x75 mm		
Protection degree	IP 65 (with connectors)	IEC 60529	
Relative humidity	5 to 85%	IEC 60068-2-30	
Operating temperature	5°C \div 50°C	IEC 60068-2-1	
Storage temperature	-25°C \div 80°C	IEC 60068-2-2	
Vibrations	5g tested 10-500Hz	IEC 60068-2-6	
Shock	22g	IEC 60068-2-27	

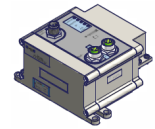

TCxC and TExC modules - CANopen

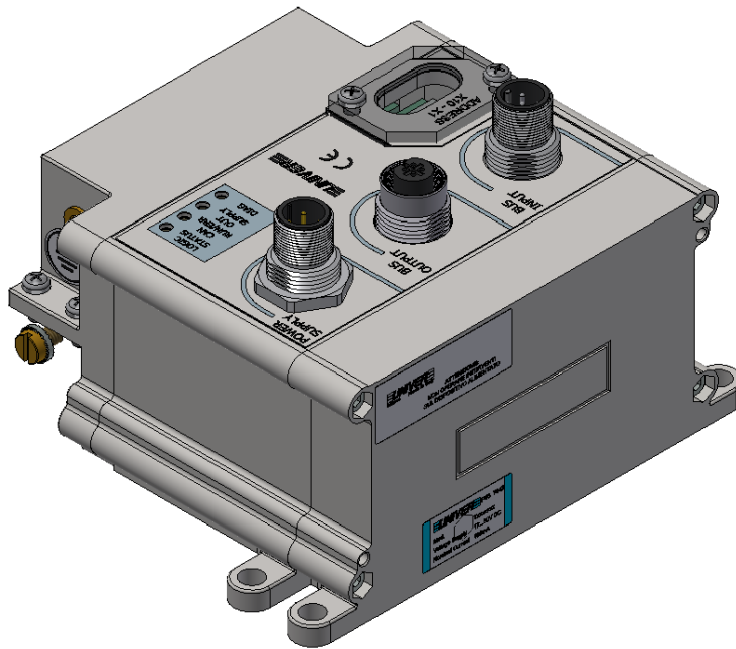

Fieldbus data		CANopen	
Input Bus connector	Circular M12 Male 5 pin A code		
Output Bus connector	Circular M12 Female 5 pin A code		
System LEDs	LOGIC STATUS	Green	
	DIAG	Red	
Auxiliary LEDs	OUT SUPPLY	Green	
BUS LED	CAN RUN/ERR	Green/Red	
Selectable Slave Adress	Selectable form 01 to 98 99 enable the function LSS (from version 2.1)		
Commutation speed	10-20-50-125-250-500-800Kbaud -1Mbaud (Autobaud from version 2.1).		
Electrical data			
Connector power supply	Circular M12 male 4 pin A code		
Logic voltage / digital inputs (VLS24)	24 Vdc ± 15%		
Nominal power	100mA (TCxC) 80mA (TExC)		
Maximal power for digital inputs	1,5A @ 20°C - overload protection		
Manifolds/outputs voltage (VA24)	24 Vdc -10% +15% (valves limit)		
Maximal power for all outputs (VA24)	2,5A max - overload protection		
Manageable outputs for valve manifolds	24 max coils - (12 bistable valves - 1,5A for 12 coils)		
Manageable auxiliary digital outputs	40 digital outputs (64 total outputs with 24 manifold coils)		
Manageable auxiliary digital inputs	64 digital inputs		
Environmental conditions			
Weight	TCxC/TExC	370g/280g	
Module overall dimensions	100x123x75 mm / 90x123x75 mm		
Protection degree	IP 65 (with connectors)	IEC 60529	
Relative humidity	5 to 85%	IEC 60068-2-30	
Operating temperature	5°C ÷ 50°C	IEC 60068-2-1	
Storage temperature	-25°C ÷ 80°C	IEC 60068-2-2	
Vibrations	5g tested 10-500Hz	IEC 60068-2-6	
Shock	22g	IEC 60068-2-27	

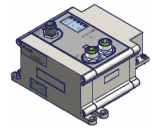

TCxLKA and TCxLKB modules - IO-Link

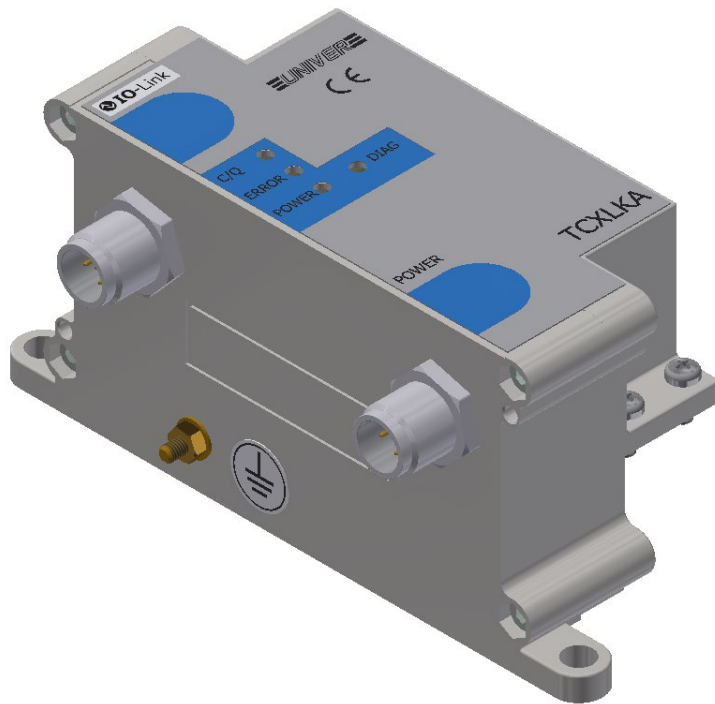

Fieldbus data		IO-Link	
Connector Bus Input and logic power supply	Circular M12 Male 5 pin A code		
BUS LED	C/Q	Green	
BUS LED	ERROR	Red	
Auxiliary LED	OUT SUPPLY	Green	
System LED	DIAG	Red	
Electronical data			
Connector power supply	Circular M12 male 4 pin A code		
Logic voltage / digital inputs (VLS24)	24 Vdc ± 15%		
Nominal power	150mA		
Manifold voltage	24 Vdc -10% +15% (valves limit)		
Maximal power for all outputs (VA24)	1,5A max - overload protection		
Manageable outputs for valve manifolds	24 max coils- (12 bistable valves - 1,5A for 12 coils)		
Environmental conditions			
Weight	TCxLKA/TCxLKB	150g/135g	
Module overall dimensions	50x123x75 mm		
Protection degree	IP 65 (with connectors)	IEC 60529	
Relative humidity	5 to 85%	IEC 60068-2-30	
Operating temperature	5°C ÷ 50°C	IEC 60068-2-1	
Storage temperature	-25°C ÷ 80°C	IEC 60068-2-2	
Vibrations	5g tested 10-500Hz	IEC 60068-2-6	
Shock	22g	IEC 60068-2-27	



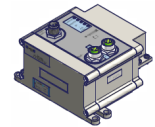

M12 connectors pinout for Profinet, EtherNet/IP, EtherCAT modules

TCxPN - TExPN

TCxEN - TExEN

TCxEC - TExEC

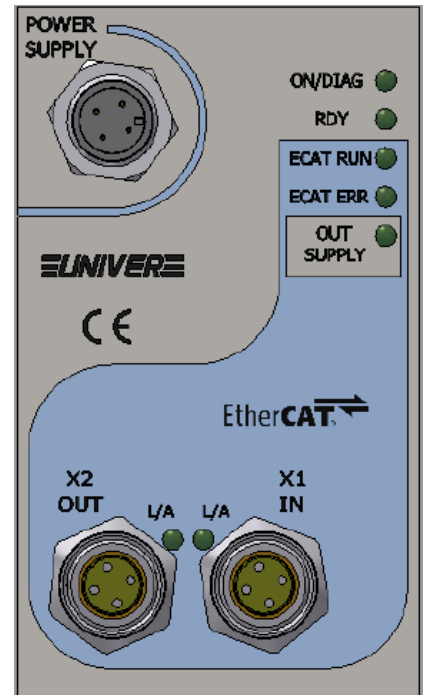
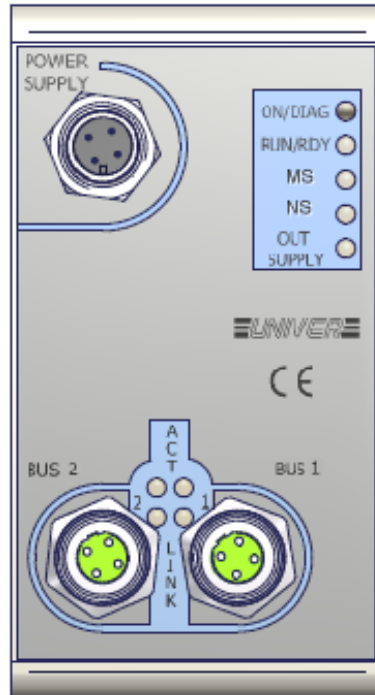
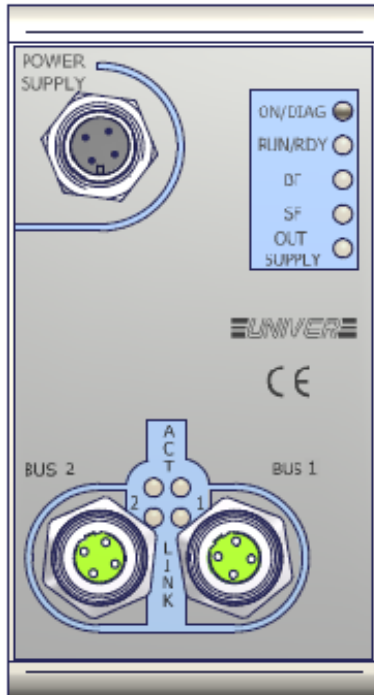

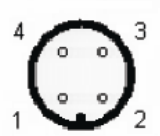

Logic and output power supply.
(M12 Male A code)
Contact side view.

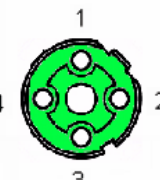

BUS1 e BUS2.
(M12 Female D code)
Contact side view

Pin	POWER SUPPLY
1	Positive logic and input power supply (VLS24)
2	Negative output power supply (OVA)
3	Negative logic and input power supply (OVLS)
4	Positive output power supply (VA24)
Case	Shield

Pin	BUS 1	BUS 2
1	TD+	TD+
2	RD+	RD+
3	TD-	TD-
4	RD-	RD-
Case	Screen	Shield

Bus 1 and Bus 2 can be used either as input or output of the fieldbus.

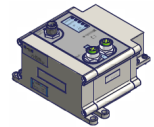

M12 connectors pinout for Profibus modules

TCxP - TExP

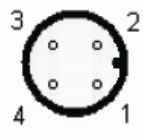

Logic and output power supply.
(M12 Male A code)
Contact side view.



OUTPUT BUS.
(M12 Female B code)
Contact side view.

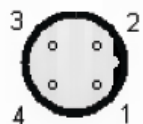

INPUT BUS.
(M12 Male B code)
Contact side view.

Pin	POWER SUPPLY
1	Positive logic and input power supply (VLS24)
2	Negative output power supply (0VA)
3	Negative logic and input power supply (0VLS)
4	Positive output power supply (VA24)
Case	Shield

Pin	BUS INPUT	Bus OUTPUT
1	NC	VP (+5V)
2	A	A
3	0V	0V
4	B	B
Case	Shield	Shield

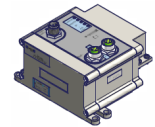

M12 connectors pinout for CANopen modules

TCxC - TExC

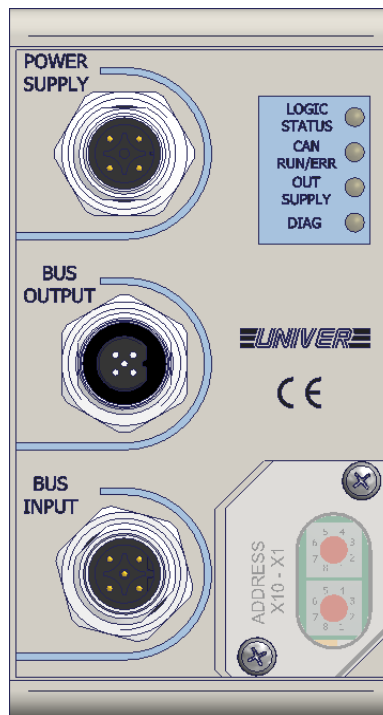

Logic and output power supply.
(M12 Male A code)
Contact side view.



OUTPUT BUS.
(M12 Female A code)
Contact side view.



INPUT BUS.
(M12 Male A code)
Contact side view.

Pin	POWER SUPPLY
1	Positive logic and input power supply (VLS24)
2	Negative output power supply (0VA)
3	Negative logic and input power supply (0VLS)
4	Positive output power supply (VA24)
Case	Shield

Pin	BUS INPUT	Bus OUTPUT
1	Drain	Drain
2	V+	V+
3	V-	V-
4	CAN-H	CAN-H
5	CAN-L	CAN-L
Case	Shield	Shield

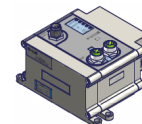

M12 connectors pinout for IO-Link modules

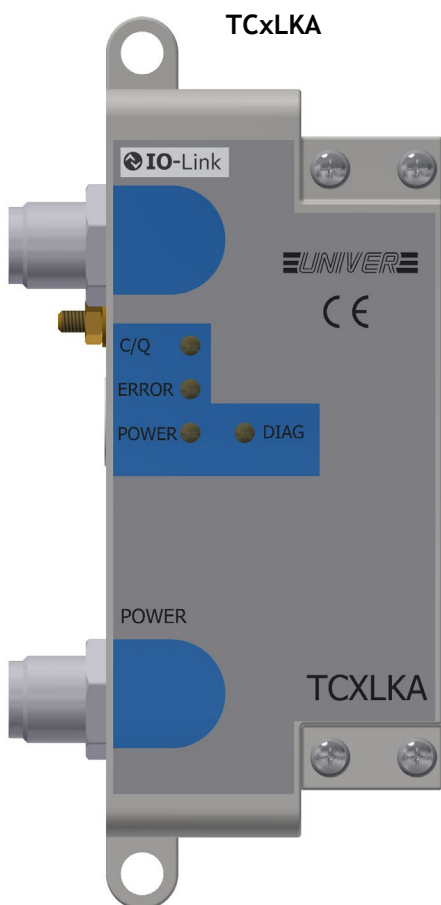

	<p>Logic power supply (TCxLKA). (M12 Male A code) Contact side view.</p>	<table border="1"> <thead> <tr> <th>Pin</th> <th>IO-Link</th> </tr> </thead> <tbody> <tr> <td>1</td> <td>Positive logic supply (+L)</td> </tr> <tr> <td>2</td> <td>NC</td> </tr> <tr> <td>3</td> <td>Negative logic supply (-L)</td> </tr> <tr> <td>4</td> <td>C/Q</td> </tr> <tr> <td>5</td> <td>NC</td> </tr> <tr> <td>Case</td> <td>Shield</td> </tr> </tbody> </table>	Pin	IO-Link	1	Positive logic supply (+L)	2	NC	3	Negative logic supply (-L)	4	C/Q	5	NC	Case	Shield
Pin	IO-Link															
1	Positive logic supply (+L)															
2	NC															
3	Negative logic supply (-L)															
4	C/Q															
5	NC															
Case	Shield															
	<p>Output power supply (TCxLKA). (M12 Male A code) Contact side view.</p>	<table border="1"> <thead> <tr> <th>Pin</th> <th>POWER</th> </tr> </thead> <tbody> <tr> <td>1</td> <td>Positive valve supply (2L)</td> </tr> <tr> <td>2</td> <td>NC</td> </tr> <tr> <td>3</td> <td>Negative valve supply (2M)</td> </tr> <tr> <td>4</td> <td>NC</td> </tr> <tr> <td>Case</td> <td>Shield</td> </tr> </tbody> </table>	Pin	POWER	1	Positive valve supply (2L)	2	NC	3	Negative valve supply (2M)	4	NC	Case	Shield		
Pin	POWER															
1	Positive valve supply (2L)															
2	NC															
3	Negative valve supply (2M)															
4	NC															
Case	Shield															

	<p>Logic and output power supply (TCxLKB). (M12 Male A code) Contact side view.</p>	<table border="1"> <thead> <tr> <th>Pin</th> <th>IO-Link</th> </tr> </thead> <tbody> <tr> <td>1</td> <td>Positive logic power supply (+L)</td> </tr> <tr> <td>2</td> <td>Positive valve power supply (2L)</td> </tr> <tr> <td>3</td> <td>Negative logic power supply (-L)</td> </tr> <tr> <td>4</td> <td>C/Q</td> </tr> <tr> <td>5</td> <td>Negative valve power supply (2M)</td> </tr> <tr> <td>Case</td> <td>Shield</td> </tr> </tbody> </table>	Pin	IO-Link	1	Positive logic power supply (+L)	2	Positive valve power supply (2L)	3	Negative logic power supply (-L)	4	C/Q	5	Negative valve power supply (2M)	Case	Shield
Pin	IO-Link															
1	Positive logic power supply (+L)															
2	Positive valve power supply (2L)															
3	Negative logic power supply (-L)															
4	C/Q															
5	Negative valve power supply (2M)															
Case	Shield															

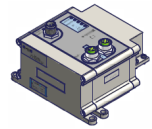

Power supply connections for Profinet, EtherNet/IP, EtherCAT modules



FE connection must be connected externally to the ground.

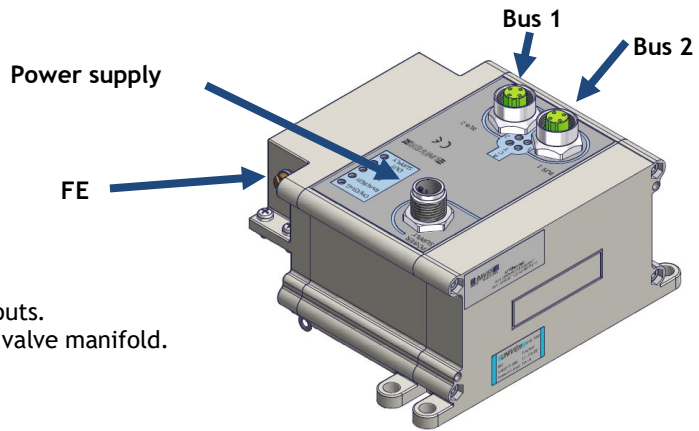

The module requires 2 supplies,
 One 24 VDC (-10% or +15 %) for logic and inputs.
 One 24 VDC (-10% or +15 %) for outputs and valve manifold.

Supply connections

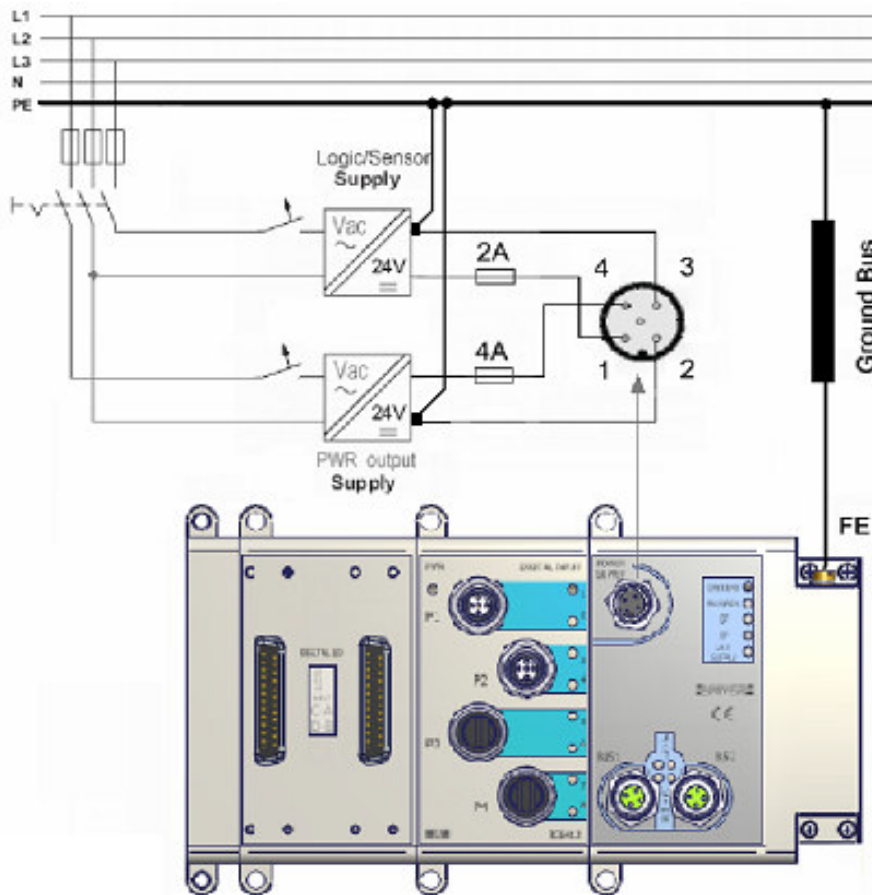

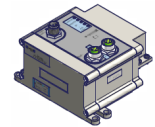

Power supply connections for Profibus, CANopen modules



PE connection must be connected externally to the ground.

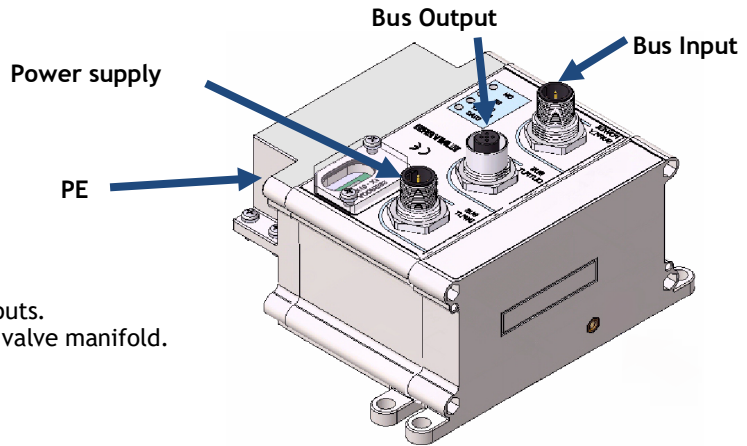

The module requires 2 supplies,
 One 24 VDC (-10% or +15 %) for logic and inputs.
 One 24 VDC (-10% or +15 %) for outputs and valve manifold.

Supply connections

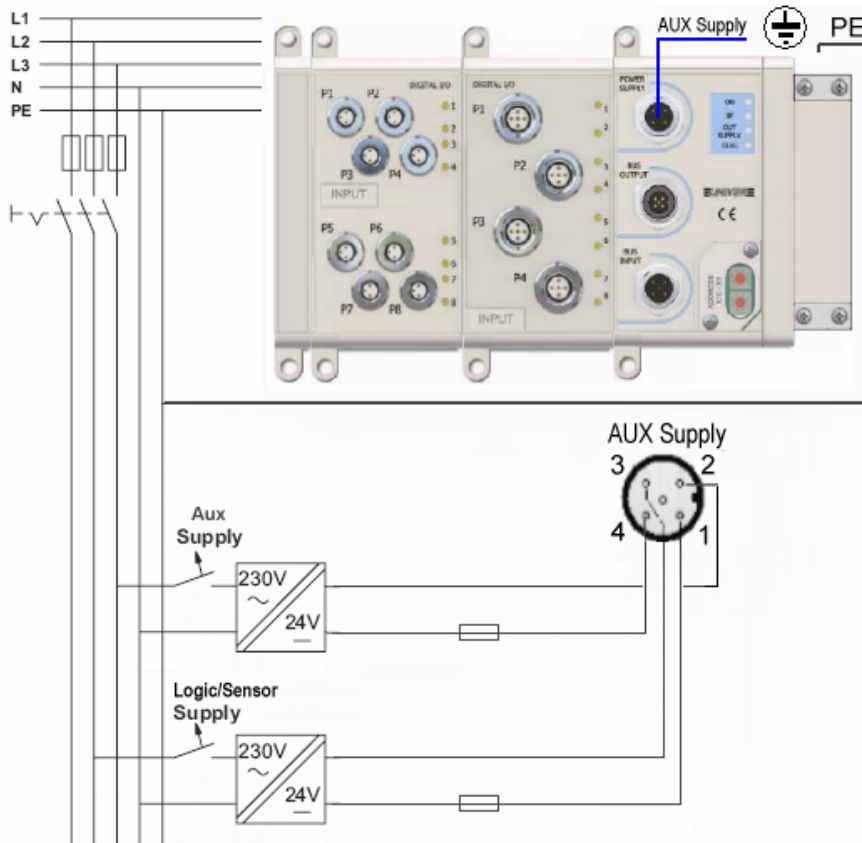

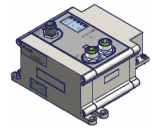

Connection to the Profinet, EtherNet/IP, EtherCAT fieldbus network



Connect the module with the appropriate network cable in accordance with the following table:

Ethernet cable specifications

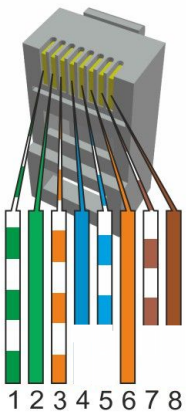

Pin	Description	10Base-T	100Base-T
1	Transmit Data+ or BiDirectional	TX+	TX+
2	Transmit Data- or BiDirectional	TX-	TX-
3	Receive Data+ or BiDirectional	RX+	RX+
4	Not connected or BiDirectional	n/c	n/c
5	Not connected or BiDirectional	n/c	n/c
6	Receive Data- or BiDirectional	RX-	RX-
7	Not connected or BiDirectional	n/c	n/c
8	Not connected or BiDirectional	n/c	n/c

Description	Features
ISO/IEC 11801 Ed. 2.0, category 5	(Category)
ISO/IEC 11801 Ed. 2.0 Class D	(Transmission performances)
Conductor cross-section	AWG 22
Maximal operating voltage	300V RMS
Massimal resistance at 20°C	57.1 Ohm / km
Transfer Impedance at 10 MHz	< 40 mOhm / m
Nominal propagation speed	68%
Delay	< 5.3 ns / m
Impedance at 1 – 100 MHz	100 +/- 15 Ohm

Connector for fieldbus TZ-M4M12-D to be connected to BUS 1 and BUS 2.

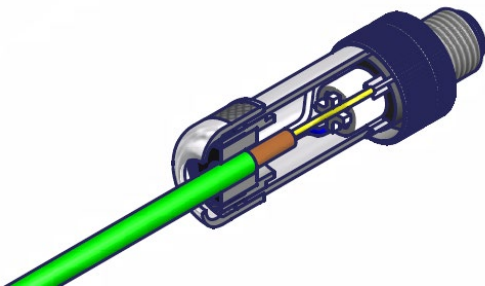
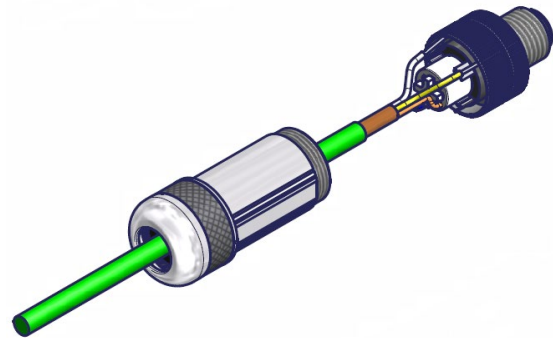
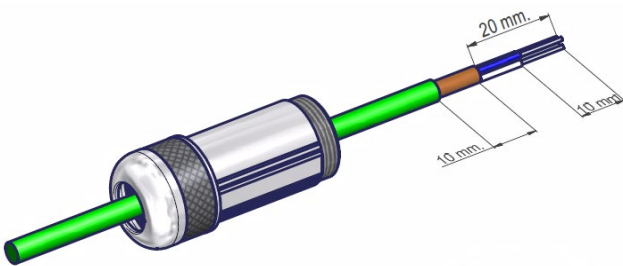

Pin	Cable color
1	Yellow
2	White
3	Orange
4	Blue
Case	Shield



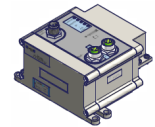

Connection to the Profibus fieldbus network

Profibus cable specifications



Description	Features
Impedence	100...130 Ohm
Capacity	< 30pF/m
Resistance	< 110 Ohm/Km
Diameter	< 0,53mm
Section	> 0,22mm ²

Connector for fieldbus TZ-M4M12-B to be connected to BUS OUTPUT.

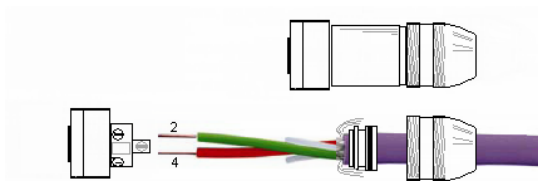
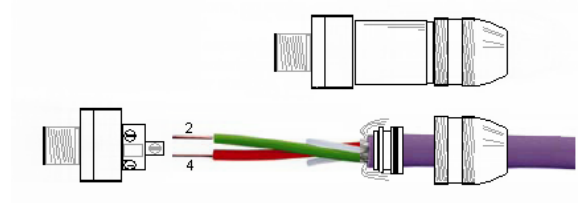

Connector for fieldbus TZ-F4M12-B to be connected to BUS INPUT.



As per "Interconnection Technology Version 1.4" of January 2007 published by the PNO, the shield of the shielded cable must be connected to connector metal case as indicated above, and not to the pin 5 of the same.

Profibus network termination

Termination TZ-M5M12-BT is to be connected to the BUS OUTPUT connector.



A Profibus network must be terminated at each end of it. The master and the last device on the network must be terminated in order to eliminate reflections, even if only 2 nodes are used.

Termination specifications:

- 2 x 390 Ohm
- 220 Ohm
- 1% Metall film
- ¼ Watt

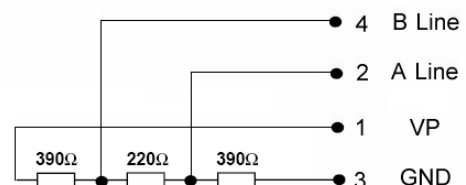

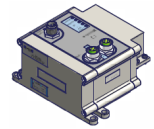

Connection to the CANopen Fieldbus

Specifacaton of the CANopen cable.



Speed	Section	mOhm/mt
50Kbit/S a 1000mt	0,75...0,8mm ² AWG18	70
100Kbit/S a 500mt	0,5...0,6mm ² AWiG20	< 60
500Kbit/S a 100mt	0,34...0,6mm ² AWG22...AWG20	< 40
1000Kbit/S a 40mt	0,25...0,34mm ² AWG23...AWG22	< 26

Connector for fieldbus **TZ-M5M12** to be connected to BUS OUTPUT.

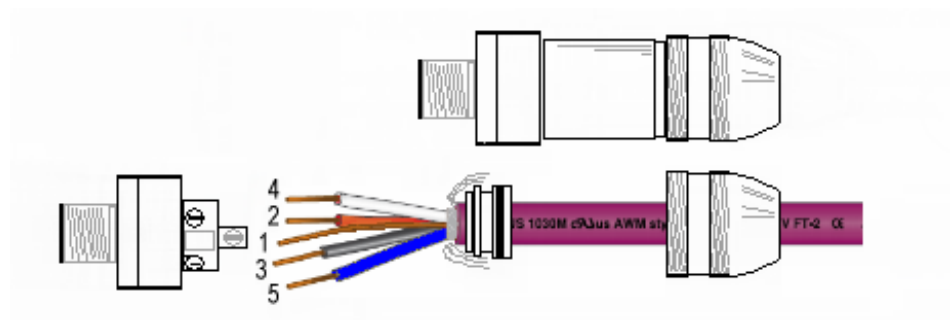

Connector for fieldbus **TZ-F5M12** to be connected to BUS INPUT.

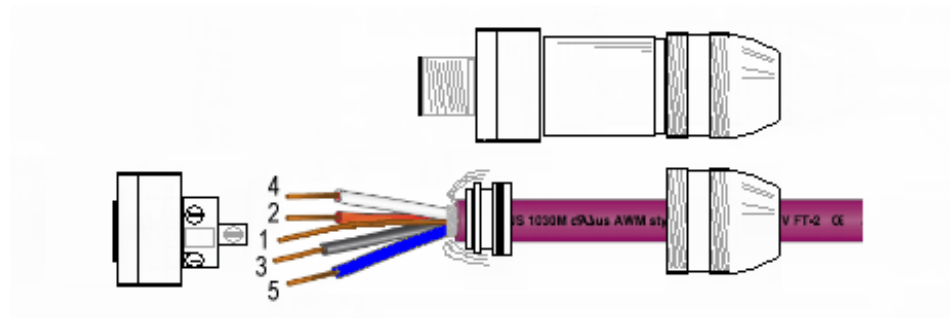

CANopen network termination

Termination TZ-M5M12T to be connected to BUS OUTPUT

A CANopen network must be terminated at each end of it. The master and the last device on the network must be terminated in order to eliminate reflections, even if only 2 nodes are used.



Termination specifications:

- 121 ohm
- 1% metal film
- ¼ Watt

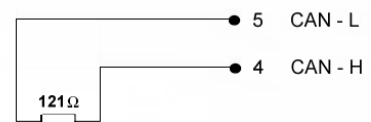

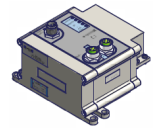

How to set Profinet, EtherNet/IP, EtherCAT network address

Profinet

The device has the following factory settings:

Name: **txxpnxxxxx**
IP Address: **171.16.0.10**
IP Mask: **255.255.255.0**
Gateway: **0.0.0.0**

EtherNet/IP

The device has the following factory settings:

IP Address: **171.16.0.250**
IP Mask: **255.255.255.0**
Gateway: **0.0.0.0**
Bootp: **Disabled**
DHCP: **Disabled**
DNS: **Disabled**



To configure these devices, it is possible to use the master software (i.e. TIA Portal for Profinet, BootP per Ethernet/IP, TwinCAT per EtherCAT, ecc) or the "Ethernet/IP Device Configuration" software available on our website (only for Profinet or Ethernet/IP).

Here below an example on how to use the "Ethernet Device Configuration" to set the IP address. Be sure that in the "Options" "Protocols", both "NetIdent" and "DCP" are ticked.

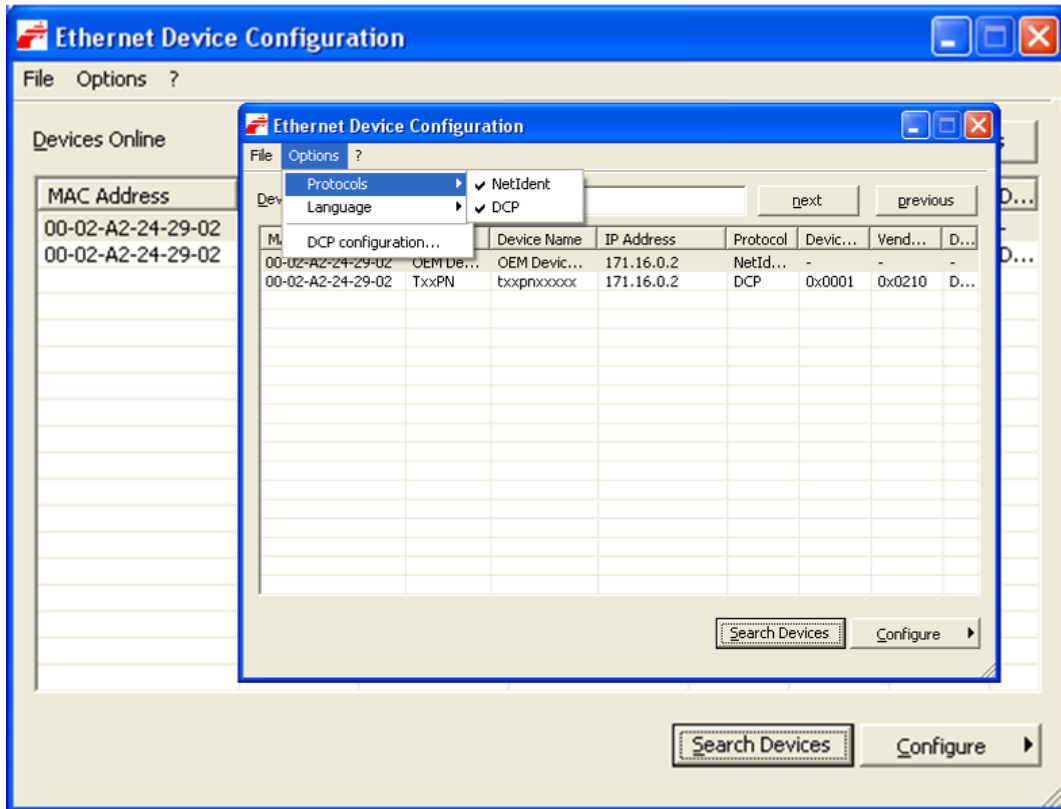
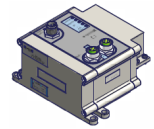

Click on "Search Devices" to perform a network scanning and to recognize the connected devices. Select from the list, the device whose MAC Address corresponds to the one of the object you want to change (the MAC Address is written on the device connector) and click the mouse's right button.

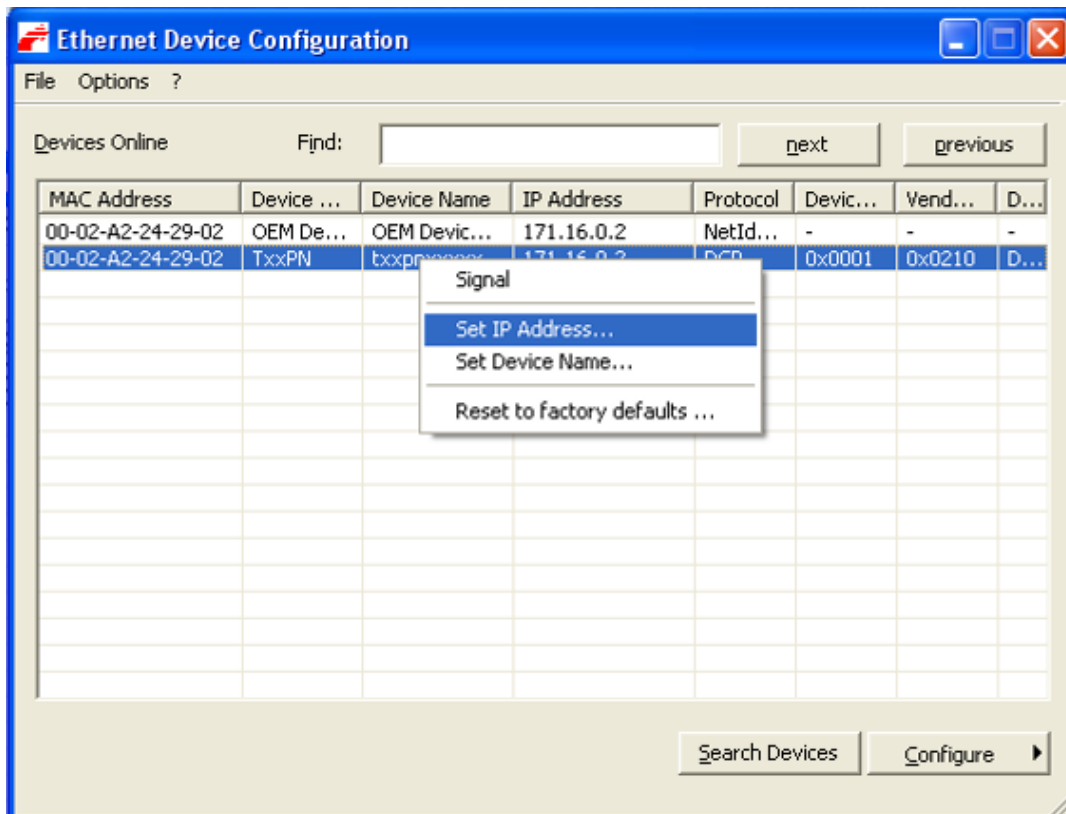

Now it is possible to modify the IP address, the subnet mask and the Gateway address.

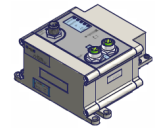
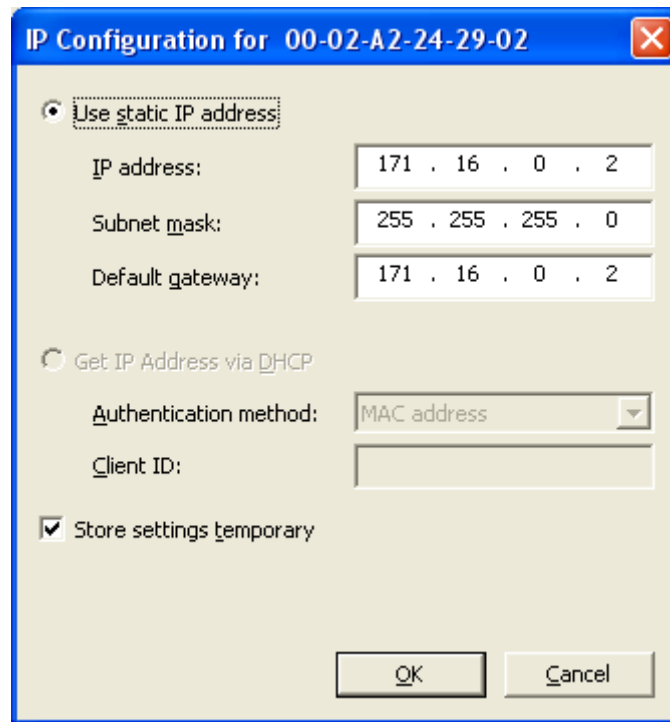
In protocols where it is foreseen, the checkbox “Set Device Name” will be active, and you can set the device name as well. The procedure is like the one used to install the IP address.
For more details on the use of the program, refer to the program “Help”



To be sure that the configured parameters become permanent, remember to remove the tick from “Store setting temporary” before clicking on “OK”, otherwise the new setting will be erased at the first device shutdown.



To be able to use the program correctly it is necessary that the PC network card is set on the same device network. (example 171.16.0.1).

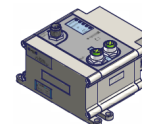

How to set Profibus network address

The valid addresses for our modules are:
from 01 to 99.

Each module has the factory address set on 02
The “Rotary Switches”, are on the upper side of the panel, under the flap.
The address is acquired only when turned on, so to change the address, turn off the device, set the address and turn the device back on so it is updated.

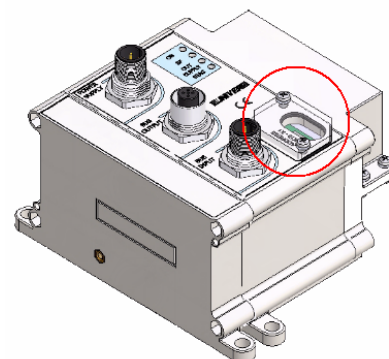
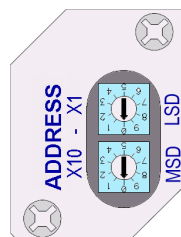

Rotary Switch	MSD	LSD
Slave address	Most significant number (x10)	Less significant number (x1)
Max. address	9	9

How to set the CANopen network address

Firmware version 2.0 o previous

Valid addresses: from 01 to 89 (*)

Firmware version 2.1 up tp 2.6

Valid addresses: from 01 to 98

99 enable the option LSS

Firmware version 2.7 forward

Valid addresses: from 01 to 89 (*)

99 enable the option LSS and/or Auto Baud Rate

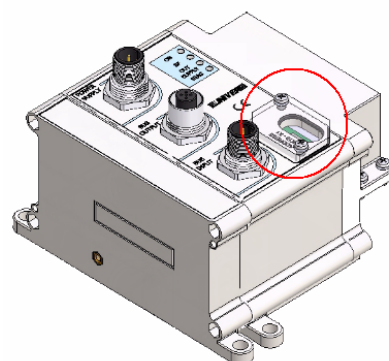
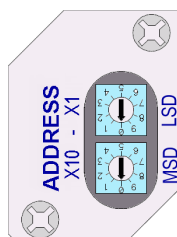

Each module leaves the factory with the address set to 63.

The “Rotary Switches” are placed on the upper part of the panel, under the flap.

The address is acquired only when it is turned on, so to change the address, turn it off, set the address and turn the device back on so that it is updated.

Rotary Switch	MSD	LSD
Slave address	Most significant digit (x10)	Less significant digit (x1)
Max. address	9	8

(*)

Rotary Switch	90	91	92	93	94	95	96	97	98	99
Baudrate (KB)	10	20	50	-	125	250	500	800	1000	LSS o Autobaud

When it is turned off, set a baud, switch it on and wait for 5", switch it off, set the desired address (< 90) and switch it on again.



To set the address, remove the cover by unscrewing the screws, set the new address and remember to properly close the cover by tightening the screws fully in order to ensure the IP65 protection degree.

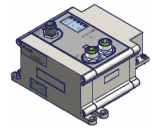

Coils, inputs and outputs addressing

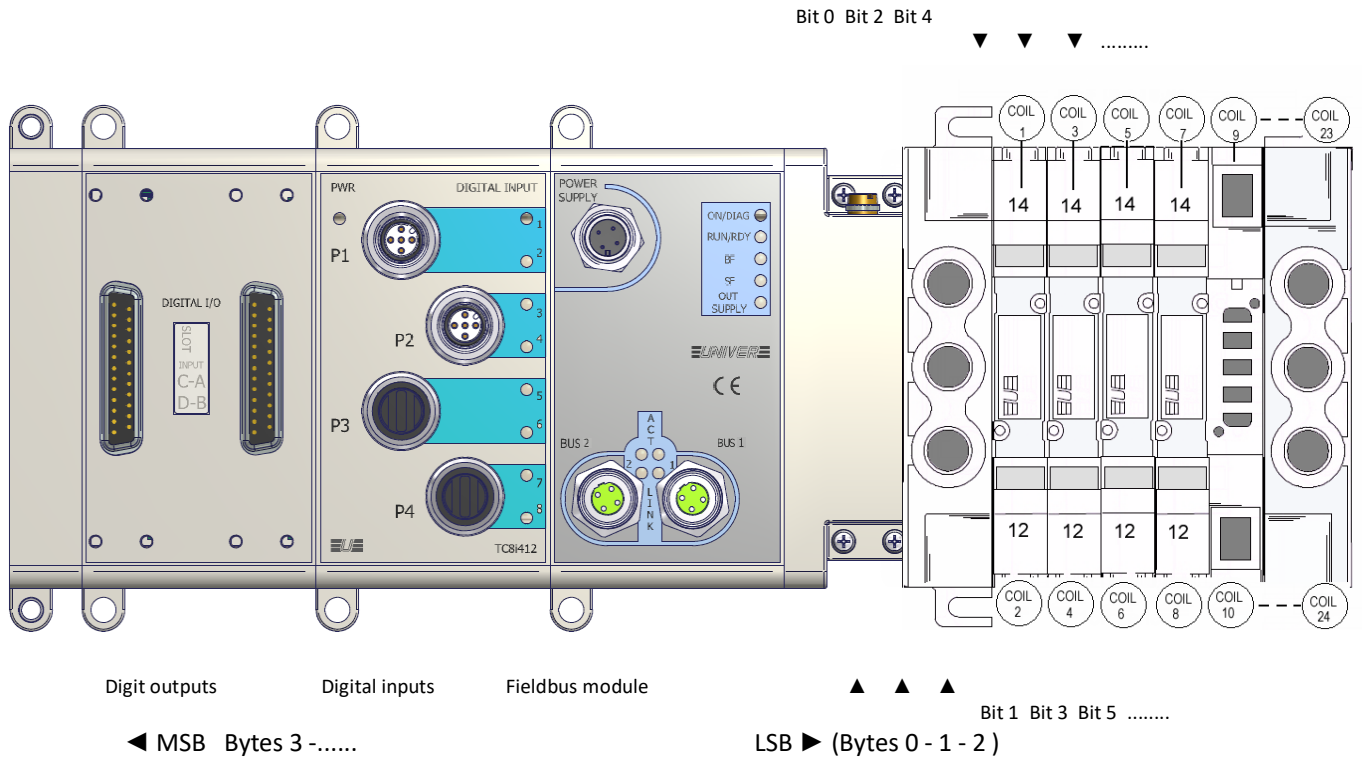

(Manifold First = TRUE or Valve manifold first = True, ecc.) (1)

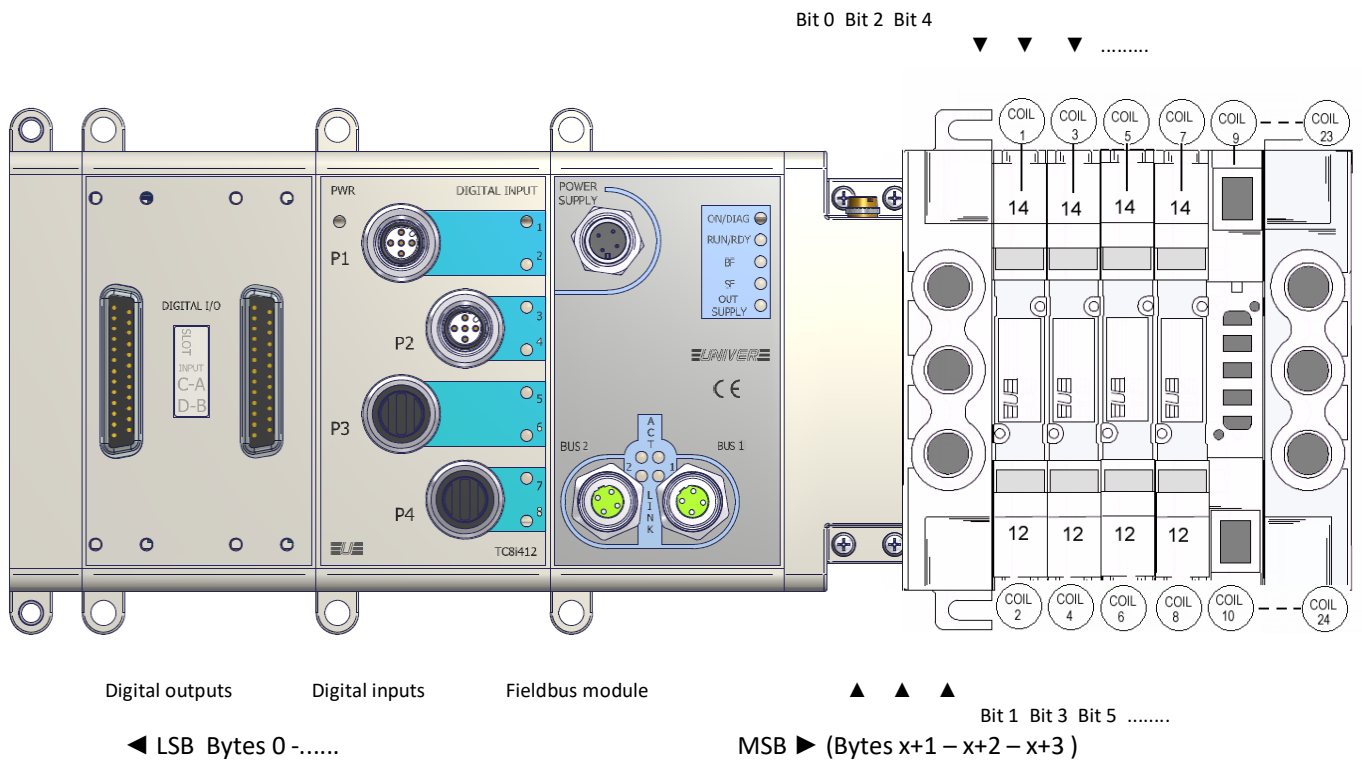

(Manifold First = FALSE or Valve manifold first = False, ecc.) (1)



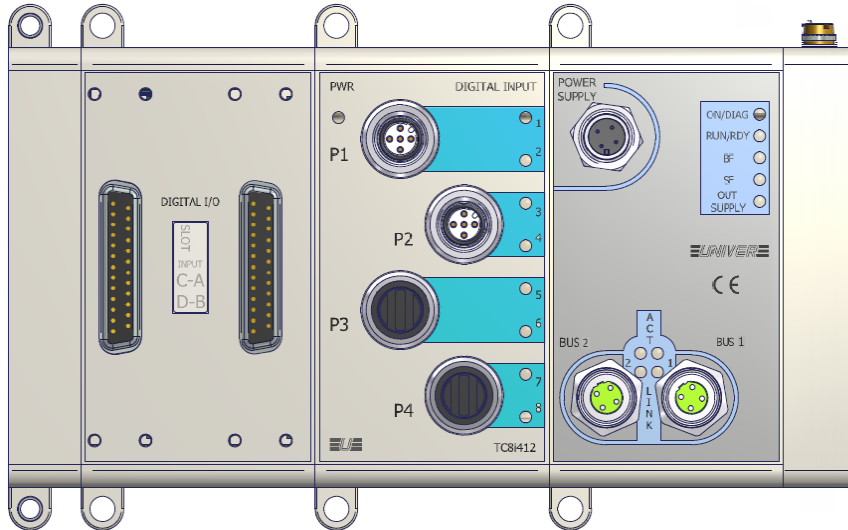
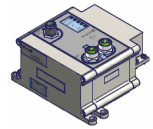

Digital outputs

Digital inputs

Fieldbus module

◀ MSB Bytes 0 -.....

- (1) The wording may vary according to the used protocol and according to the selected language, if supported by the configuration file.



The physical position of the modules determines the rising of the given Bytes, according to a sequence that always evolves from the fieldbus module to the left.

A specific sequence of the module installation must be observed to ensure that the system works properly.

First the input modules (TC8I412, TC16I812, TC8I808, TCR32ID), then the additional modules TCR1616 (discontinues), after the output modules (TC8U412 or TCR32UD) and in the end the possible modules for the electric clamps (TC-ECSM, TC-2ECD).

Product identification label

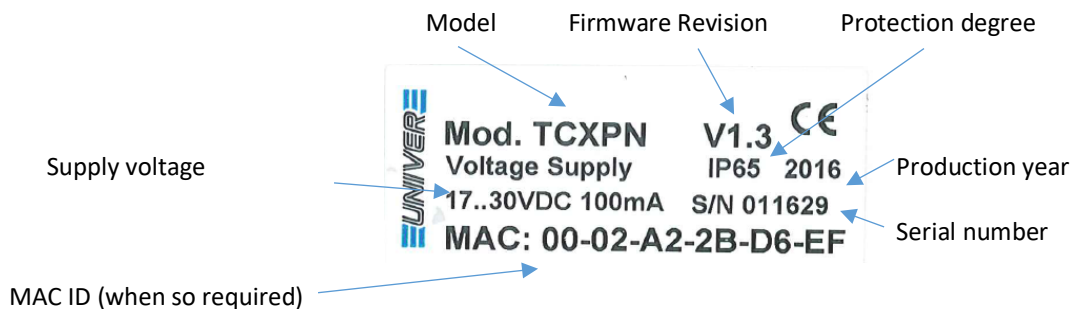

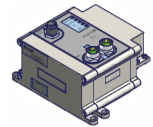

Allocation of manifold valve Byte/Bit

		Coil	Consume Byte-Bit	Coil	Consume Byte-Bit	Coil	Consume Byte-Bit
Valve function	Side 14	1	0-0	9	1-0	17	2-0
	Side 12	2	0-1	10	1-1	18	2-1
	Side 14	3	0-2	11	1-2	19	2-2
	Side 12	4	0-3	12	1-3	20	2-3
	Side 14	5	0-4	13	1-4	21	2-4
	Side 12	6	0-5	14	1-5	22	2-5
	Side 14	7	0-6	15	1-6	23	2-6
	Side 12	8	0-7	16	1-7	24	2-7



TC modules always use 24 Bit (3 Bytes) regardless the actual number of valves.

Allocation of Byte/Bit of further output modules

		Byte-Bit Consumes				
Slot		1	2	3	4	5
Pin-port	P 1-4	3-0	4-0	5-0	6-0	7-0
	P 1-2	3-1	4-1	5-1	6-1	7-1
	P 2-4	3-2	4-2	5-2	6-2	7-2
	P 2-2	3-3	4-3	5-3	6-3	7-3
	P 3-4	3-4	4-4	5-4	6-4	7-4
	P 3-2	3-5	4-5	5-5	6-5	7-5
	P 4-4	3-6	4-6	5-6	6-6	7-6
	P 4-2	3-7	4-7	5-7	6-7	7-7



The maximal number of configurable digital outputs is 64/88 Bit (8/11 Bytes), based on the models of the used connectors.

Allocation of Byte/Bit of further input modules

		Byte-Bit Produces						
Slot		1	2	3	4	5	6	7
Pin-ports	P 1-4	0-0	1-0	2-0	3-0	4-0	5-0	6-0
	P 1-2	0-1	1-1	2-1	3-1	4-1	5-1	6-1
	P 2-4	0-2	1-2	2-2	3-2	4-2	5-2	6-2
	P 2-2	0-3	1-3	2-3	3-3	4-3	5-3	6-3
	P 3-4	0-4	1-4	2-4	3-4	4-4	5-4	6-4
	P 3-2	0-5	1-5	2-5	3-5	4-5	5-5	6-5
	P 4-4	0-6	1-6	2-6	3-6	4-6	5-6	6-6
	P 4-2	0-7	1-7	2-7	3-7	4-7	5-7	6-7



The maximal number of configurable digital inputs is 64 Bit (8 Byte).

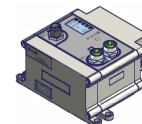

Allocation of Byte/Bit of electric clamp modules

Module	Clamp	Byte-Bit Inputs			Byte-Bit outputs	
		Opening	Closing	Fault	Opening	Closing
1	1	0-0	0-1	0-2	0-0	0-1
	2	0-3	0-4	0-5	0-2	0-3
2	3	1-0	1-1	1-2	0-4	0-5
	4	1-3	1-4	1-5	0-6	0-7
3	5	2-0	2-1	2-2	1-0	1-1
	6	2-3	2-4	2-5	1-2	1-3
4	7	3-0	3-1	3-2	1-4	1-5
	8	3-3	3-4	3-5	1-6	1-7



Input and Output bytes of electric power clamps modules are subsequent to the input and output modules already in the system.

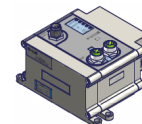

Auxiliary input and output modules

COD. TC8I412

N.8 digital inputs - M12

COD. TC16I812

N.16 digital inputs - M12

COD. TC8U412

N.8 digital outputs - M12

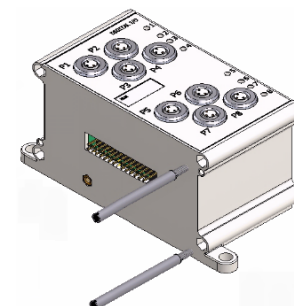
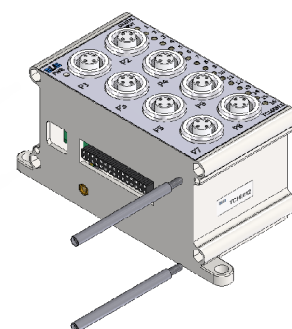
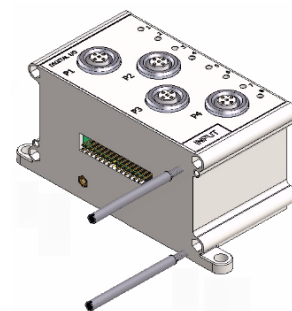

M12 Female A code
Contact side view

Pin	TC8I412 TC16I812	TC8U412
1	VLS24	-
2	Input 2	Output 2
3	0VLS	0VA
4	Input 1	Output 1
Case	Shield	Shield

COD. TC8I808

N.8 digital inputs - M8



M8 Female
Contact side view

Pin	TC8I808
1	VLS24
3	0VLS
4	Input

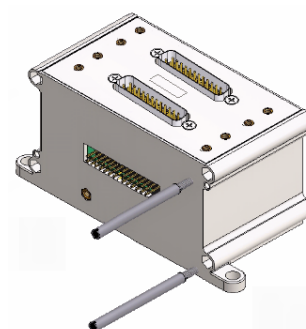

P1-P2 Pin N.	TCR32ID	TCR32UD
1	Input 0-0	Output 0-0
2	Input 0-1	Output 0-1
3	Input 0-2	Output 0-2
4	Input 0-3	Output 0-3
5	Input 0-4	Output 0-4
6	Input 0-5	Output 0-5
7	Input 0-6	Output 0-6
8	Input 0-7	Output 0-7
9	Input 1-0	Output 1-0
10	Input 1-1	Output 1-1
11	Input 1-2	Output 1-2
12	Input 1-3	Output 1-3
13	Input 1-4	Output 1-4
14	Input 1-5	Output 1-5
15	Input 1-6	Output 1-6
16	Input 1-7	Output 1-7
17/18	-	-
19/20	0VLS	-
21/22	VLS24	-
23/24	-	0VA
25	-	-
Case	Shield	Shield



COD. TCR32UD

16+16 digital outputs
Remote module

COD. TCR32ID

16+16 digital outputs
Remote module

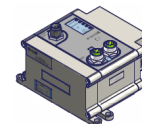

Auxiliary input and output modules (features)

Input module specifications

Code	TC8I412 TC8I412-2F	TC16I812 TC16I812-2F	TC8I808 TC8I808-2F	TCR32ID TCR32ID-2F
Connector Type	Circular 4 x M12	Circular 8 x M12	Circular 8 x M8	DSub 2 x 25pins
Input of each module	8	16	8	16+16
Commutation logic	Devices 2 or 3 wires PNP (for 2-wires connector use -2F version)			
Supply voltage (VLS24)	24Vdc +/- 15%			
Module consumption. (VLS24) (6)	25mA	20mA	15mA	20mA
Max. supply power for input	160mA (2) 400mA (2) (3)			160mA (4) 400mA (4) (5)
Input level "OFF"	0Vdc to 5Vdc			
Input level "ON"	10Vdc to 30Vdc			
Typical power for active input	5mA (12mA for 2F version)			
Signal input "ON"	LED Green			
Signal power supply	LED Green (with power supply but LED off > module overload)			

Output module specifications

Code	TC8U412	TCR32UD
Connector type	Circular 4 x M12	DSub 2 x 25pins
Output for each module	8	16+16
Commutation logic	PNP	
Output voltage (VA24)	24 Vdc -10% + 15% (valve limit)	
Power for each output	0.3A	
Power for each output (10mS)	1.0A	
Overload protection	1.2A	
Power for each module	1.5A (1)	
Module consumption. (VLS24) (6)	70mA	65mA
Signal output "ON"	LED Yellow	
Signal power supply	LED Green (with power supply but LEF off > module overload)	

Environmental conditions

Weight	from 170g to 350g based on the module	
Module overall dimensions	55x125x75 mm	
Protection degree	IP 65 (with connectors)	IEC 60529
Relative humidity	5 to 85%	IEC 60068-2-30
Operating humidity	5°C ÷ 50°C	IEC 60068-2-1
Storage temperature	-25°C ÷ 80°C	IEC 60068-2-2
Vibrations	5g tested 10-500Hz	IEC 60068-2-6
Shock	22g peak	IEC 60068-2-27



Make sure that all connectors are perfectly screwed, and those not used are blocked with appropriate plugs (ZJM12-, ZJM08- TSCFN24SCAT), in order to guarantee the IP65 requirements. The maximum length of the input and / or output cables allowed is 10 meters.

- (1) The maximal power for all output modules, included the valve manifold is 2.5A.
- (2) Maximal power for each single group of 8 inputs.
- (3) TC8I808 and TC8I412 produced after 07/2022.
TC16I812 produced after 09/2022 (week 36).
TC16I812-2F produced after 01/10/2022.
This version cannot be used on TxxC, TxxD, TxxP produced before 07/2022.
- (4) Maximal power for each single group of 16 inputs is 160mA.
- (5) The maximal power for each single group of 16 inputs (included input consumption).
TCR32ID produced after 07/2022
This version cannot be used on TxxC, TxxD, TxxP produced before 07/2022.
- (6) Input Consumption excluded

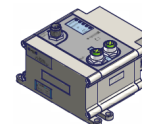

Supply and separator modules

COD.TCXUSM12
Power supply/ M12 Separator



M12 Male A code
Contact side view



M12 Female A code
Contact side view

Pin	TCXSM12
1	Positive logic and input power supply (VLS24)
2	Negative output power supply (0VA)
3	Negative logic and input power supply (0VLS)
4	Positive output power supply (VA24)
Case	Shield

(Preliminary)

COD.TCXUS78
Power supply/ 7/8 separator



Power Supply IN
7/8 Male 5-pole
Contact side view



Power Supply OUT
7/8 Female 5-pole
Contact side view

Pin	TCXSM12
1	Negative output power supply (0VA)
2	Negative logic and input power supply (0VLS)
3	FE
4	Positive logic and input power supply (VLS24)
5	Positive output power supply (VA24)
Case	Shield (PE)

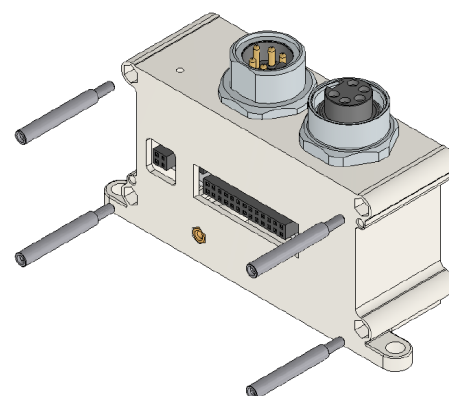

When using one of these modules with standard communication systems, keep in mind that its male power connector (which has uncovered pins) is energized, being connected in parallel, therefore, if not used, it must be protected with a special plug.
To use the module as "Separator" simply remove the JP1 Jumper located on the lower printed circuit near the 26-pole connector

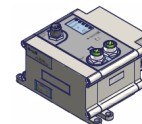

Supply and separator modules (features)

Output module specifications

Code	TCXUSM12	TCXUS78
Input connector	Circular M12 male 4 poles	Circular 7/8 male 5 poles
Output connector	Circular M12 female 4 poles	Circular 7/8 female 5 poles
Supply voltage	24 Vdc -10% + 15% (valve limit)	
Manageable supply input/output	4A	12A
Overload protection - Logic	1.2A	1.4A 2.3A (1)
Overload protection - Outputs	2.5A	2.5A 3.1A (1)
Supply signal "Out Supply"	LED Green with power supply but LED off > module overload	

Environmental conditions

Weight	Based on the module	
Module overall dimensions	35x125x75 mm	
Protection degree	IP 65 (with connectors)	IEC 60529
Relative humidity	5 to 85%	IEC 60068-2-30
Operating temperature	5°C ÷ 50°C	IEC 60068-2-1
Storage temperature	-25°C ÷ 80°C	IEC 60068-2-2
Vibrations	5g tested 10-500Hz	IEC 60068-2-6
Shock	22g peak	IEC 60068-2-27

(1) from October 01 2022

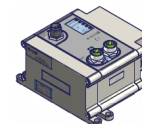

Modules for electric power clamps

COD.TC-ECSM

Power supply module for TC-2ECD.
Harting connector 40A to supply up to 4 modules TC-2ECD.

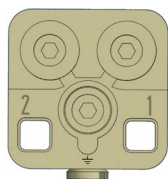

Harting Han Q 2/0 female
Contact side view

Pin	Function
1	24V motor
2	0V motor
3	Ground

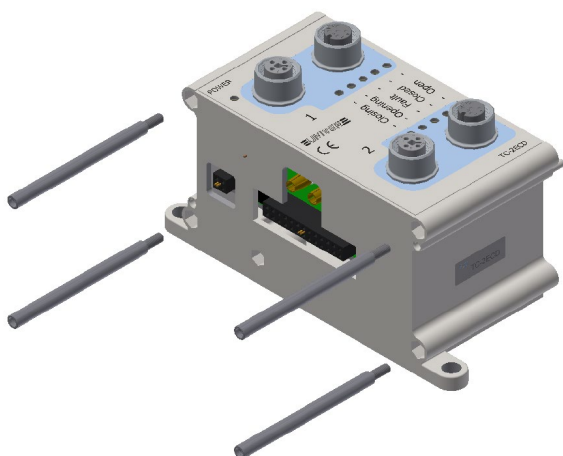
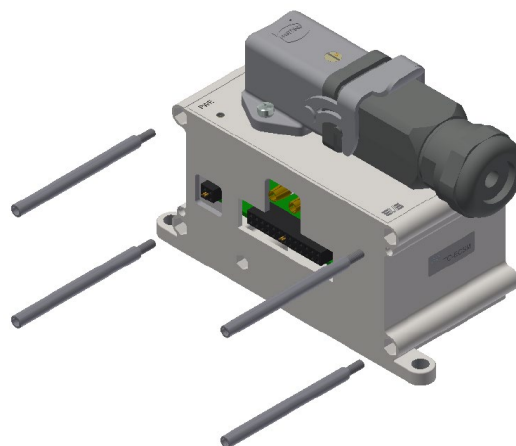

COD.TC-2ECD

Control unit for 2 clamping devices.
Connector M12 5 pin A code for signals.
Connector M12 4 pin T code for power.



M12 Female A code
Contact side view

Pin	Function
1	Power supply (VLS24)
2	Clamp open position
3	Power supply (0VLS)
4	Clamp closed position
5	Error
Case	Shield

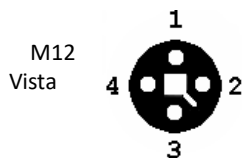

M12
Vista Female T code
Contact side view

Pin	Function
1	24V Motor
2	Opening Command
3	0V Motor
4	Closing Command
Case	Shield



These modules are compatible with the following firmwares or greater version:
Profinet V1.3, EtherNet/IP V1.2, EtherCAT V1.2, Profibus V2.4, CANopen V2.3.
The maximal number of TC-2ECD modules for each serial system is 4 (8 LAE140...LAE350)
In case of use with LAE950, the maximal number of modules is 2, anyway the total maximal consumption must not exceed 32A.
The TC-ECSM module must be installed after all I/O modules in the system, after that can be installed only TC-2ECD modules.



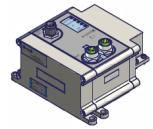

Modules for electric clamps (features)

Supply unit data		TC-ECSM	
Supply connector	Harting HAN Q 2/0 da 40A		
Auxiliary LED	Power	green	
Electrical data			
Supply connector	Harting HAN Q 2/0 da 40A		
Voltage for electric devices	24 Vdc +5% -15% (4)		
Nominal power	32A max		
Environmental conditions			
Weight	450g		
Module overall dimensions	55x123x75 mm		
Protection degree	IP 65 (with connectors)	IEC 60529	
Relative humidity	5 to 85%	IEC 60068-2-30	
Operating temperature	5°C ÷ 50°C	IEC 60068-2-1	
Storage temperature	-25°C ÷ 80°C	IEC 60068-2-2	
Vibrations	5g tested 10-500Hz	IEC 60068-2-6	
Shock	22g	IEC 60068-2-27	

Control unit data		TC-2ECD	
Device connector	Circular M12 Female 4 pin T code motor supply and controls. Circular M12 Female 5 pin A code for logic and inputs power supplyi.		
System LED	CLOSED	Green	
	OPEN	Green	
	FAULT	Red	
	CLOSING	Yellow	
	OPENING	Yellow	
Auxiliary LED	Power	Green	
Functions	Optimized power control through automatic delayed command of the clamping devices. (5)		
Electrical data			
Motor power connector	Circular M12 male 4 pin T code		
Motor supply voltage	24 Vdc +5% -15% (4)		
Nominal power	8A max		
Connector for logic supply and signals	Circular M12 male 5 pin A code		
Logic voltage (VLS24)	24 Vdc ±15%		
Maximal logic power (VLS24)	35mA		
Mangeable devices	2 devices - clamp size 40/50/63/80		
Manageable digital command outputs	4 digital outputs (open-close commands for each device)		
Manageable digital inputs	6 digital inputs (open, close, error for each device)		
Environmental conditions			
Weight	390g		
Module overall dimensions	55x123x75 mm		
Protection degree	IP 65 (with connectors)	IEC 60529	
Relative humidity	5 to 85%	IEC 60068-2-30	
Operating temperature	5°C ÷ 50°C	IEC 60068-2-1	
Storage temperature	-25°C ÷ 80°C	IEC 60068-2-2	
Vibrations	5g tested 10-500Hz	IEC 60068-2-6	
Shock	22g	IEC 60068-2-27	

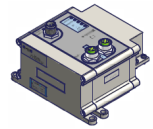

Make sure that all connectors are perfectly screwed, and those not used are blocked with appropriate plugs (ZJM12-, ZJM08- TSCFN24SCAT), in order to guarantee the IP65 requirements.
The maximum length of the input and / or output cables allowed is 10 meters and cables must be shielded.

- (1) The maximal power for all clamping device modules is 32A.
- (2) The maximal power for all clamping device modules and inputs is 1,5A.
- (3) The maximal number of manageable modules is 4 (2 in case of 4 size 80 power clamps).
- (4) The voltage cannot exceed +10% and can affect the cycle time of the connected device.
 Make sure that the cable section is proper to the connected device consumption.
 A voltage drop on the cables causes a slowdown in the operating cycle.
- (5) The optimized power management can be obtained by setting in the device configuration the two proper commands for clamping devices.
 By setting the number of clamping devices that need to be controlled simultaneously (1-8) and the delayed time (25...400mS), it is possible to optimize the instantaneous power, so to choose a smaller power supply.
 Therefore the master activates simultaneously more clamping devices, whose functioning will be automatically delayed in accordance to the configured parameters.

8 Power camps – size 50

Standard

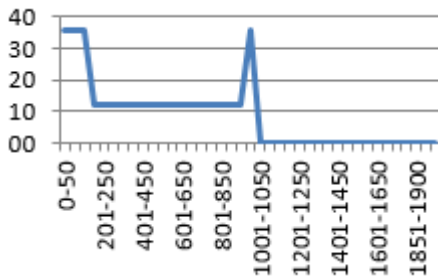

“Automatic Delayed Command”
 2 simultaneous clamps 125mS delay

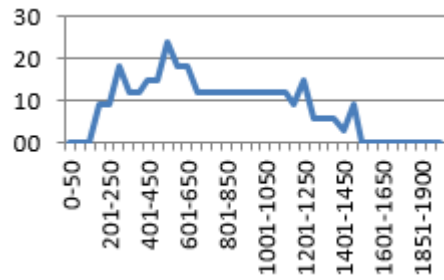

“Automatic Delayed Command”
 2 simultaneous clamps 130mS delay

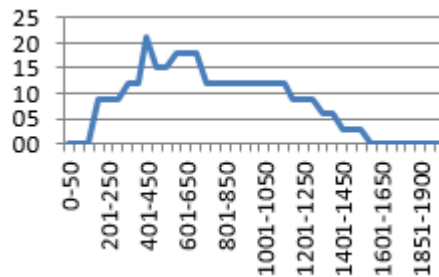

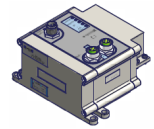



Accessories for serial modules

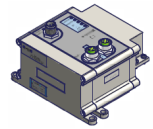



	Description	Type	Protection degree	Code
	Power Supply Profinet EtheNet/IP EtherCAT Profibus DP CANOpen IO-Link TCxLKA	M12 4 pins female A code	IP67	TZ-F4M12
	Fieldbus Profinet EtheNet/IP EtherCAT	M12 4 pins male D code	IP67	TZ-M4M12-D
	Fieldbus Input Profibus	M12 4 pins female B code	IP67	TZ-F4M12-B
	Fieldbus Output Profibus	M12 4 pins male B code	IP67	TZ-M4M12-B
	Terminating connector Profibus	M12 4 pins male B code	IP65	TZ-M4M12-BT
	Fieldbus Input CANopen	M12 5 pins male A code	IP67	TZ-M5M12
	Fieldbus Output CANopen IO-Link	M12 5 pins female A code	IP67	TZ-F5M12
	Terminating connector CANopen	M12 5 pins female A code	IP65	TZ-F5M12-T
	M8 Plug M12 Plug	Closing plugs for unused female connectors	IP65	ZJM08- ZJM12-



Accessories for clamping device modules

	Description	Type	Protection degree	Code
	Power supply Motor and Commands (Module side)	M12 4 pins male T code	IP67	TZ-M4TM12
	Power supply Logic and signals (Module side)	M12 5 pins male A code	IP67	TZ-M5M12

Connection cables for clamping device modules

	Description	Type	Protection degree	Code
	Power supply Motor and Commands (Wired on clamp side)	M12 4 pins female T code 4x1,5mm ² length: 1,5mt/3,0mt/5,0mt	IP67	
	Power supply Logic and signals (wired only on clamp side)	M12 5 pins female A code 5x0,34mm ² length: 1,5mt/3mt/5mt	IP67	
	Power supply Motor and Commands (Wired on both ends)	M12 4 pins female T code 4x1,5mm ² length 5mt	IP67	
	Power supply Logic and signals (Wired on both ends)	M12 5 pins female A code 5x0,34mm ² length:1,5mt/3mt/5mt	IP67	



The connection cables must be shielded.
The shield must be connected to the metal part of the connector body

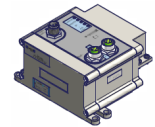

Connection cables for remote modules

- Using TSCF cables, the connection to the valve manifold by the user is easier.
- The use of the 25-pin DSub connector makes it possible to interface with a wide range of standard valve manifolds.
- The correctly installed UNIVER case guarantees the IP65 protection degree.
- Max. bending radius of the cable:
Fixed installation 80mm, mobile installation 120mm
- PG9 output cable press diameter 9.4mm.

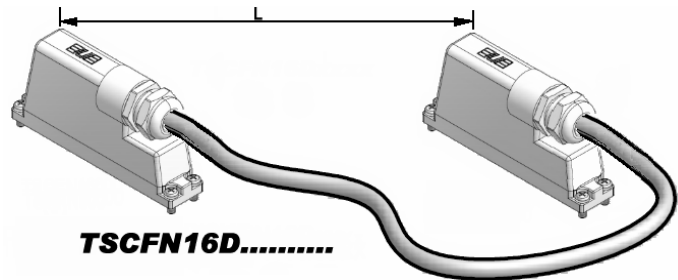

Cables with connector D-sub

TSCFN16D0300	Double connector 16 signals L 3mt.
TSCFN16D0500	Double connector 16 signals L 5mt.
TSCFN16D1000	Double connector 16 signals L 10mt.
TSCFN16S0300	Double connector 16 signals L 3mt.
TSCFN16S0500	Single connector 16 signals L 5mt.
TSCFN16S1000	Single connector 16 signals L 10mt.

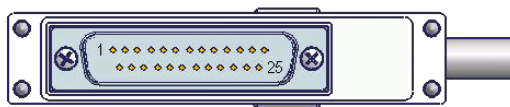
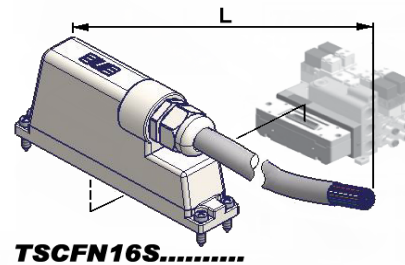

Dsub 25 pins male

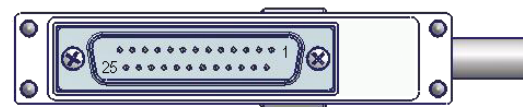

Dsub 25 pins female







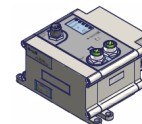

















For other accessories please visit our website

www.univer-group.com







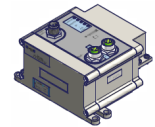





















LED Status and Diagnostics - Profinet

LED	Color	Status	Meaning
ON/Diag		On	No error.
		Flashing	Error, see error codes table for further details.
		Flashing	Fatal error, see error codes table for further details..
Run/Rdy		On	Operative system completely loaded and ready.
		On	Error during loading of operative system or configuration.
		Flashing	Boot loader mode active (6 Blink No 2 nd Stage Loader Loaded).
		Flashing	Operating system missing (2 nd Stage Loader Loaded).
BF		On	System not configured; no actual connection to the bus; Master not communicating.
		Flashing	No data exchange (Wrong configuration on the master).
		Off	No error.
SF		On	Generic or extended diagnostics; watchdog timeout; system error.
		Flashing	DCP service signal sent via BUS.
		Off	No error.
OUT SUPPLY		On	Power supply (24VA) on. (manifold and output supply).
		Off	Missing power supply (24VA). (manifold and output supply).
LINK 1		On	Ethernet connection on channel 1.
		Off	No Ethernet connection on channel 1.
LINK 2		On	Ethernet connection on channel 2.
		Off	No Ethernet connection on channel 2.
ACT 1		Flashing	Message Transmission/Receipt on channel 1.
		Off	No Message Transmission/Receipt on channel 1.
ACT 2		Flashing	Message Transmission/Receipt on channel e 2.
		Off	No Message Transmission/Receipt on channel 2.







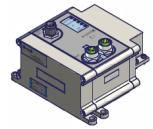





















Status and Diagnostics - EtherNet/IP LED

LED	Color	Status	Meaning
ON/Diag		On	No error.
		Flashing	Error, see error codes table for further details.
		Flashing	Fatal error, see error codes table for further details..
Run/Rdy		On	Operative system completely loaded and ready.
		On	Error during loading of operative system or configuration
		Flashing	Boot loader mode active (6 Blink No 2nd Stage Loader Loaded).
		Flashing	Operating system missing (2nd Stage Loader Loaded).
MS		On	Working (the device is correctly working)
		Flashing	Standby (the device is not configurated)
		On	Serious failure (the device has identified a non-recoverable error).
		Flashing	Minor failure (the device has identified a recoverable error).
		Off	Missing power supply (VLS24).
NS		On	Device connected.
		Flashing	No connection. (One IP address is configurated, but there is no CIP connection).
		On	Double IP address.
		Flashing	Connection Timeout.
		Off	No configurated IP address.
OUT SUPPLY		On	Power supply on (24VA). (Manifold and output power supply).
		Off	No power supply (24VA). (Manifold and output power supply).
LINK 1		On	Ethernet connection on channel 1.
		Off	No Ethernet connection on channel 1.
LINK 2		On	Ethernet connection on channel 2.
		Off	No Ethernet connection on channel 2.
ACT 1		Flashing	Message Transmission/Receipt on channel 1..
		Off	No Message Transmission/Receipt on channel 1.
ACT 2		Flashing	Message Transmission/Receipt on channel 2.
		Off	No Message Transmission/Receipt on channel 2.



LED Status and Diagnostics - EtherCAT

LED	Color	Status	Meaning
ON/Diag		On	No error.
		Flashing	Error, see error codes table for further details
		Flashing	Fatal error, see error codes table for further details..
Rdy		On	Operative system completely loaded and ready
		On	Error during loading of operative system or configuration.
		Flashing	Boot loader mode active (6 Blink No 2nd Stage Loader Loaded).
		Flashing	Operating system missing (2nd Stage Loader Loaded)
ECAT Run		On	Working (the device is correctly working).
		Flickering	Initialization or Bootstrap
		Flashing	Pre-Operational status.
		1 Flashing	Safe-Operational status.
		Off	Initialization.
ECAT Err		On	Error in the device.
		Tremolante	Boot Error.
		Flashing	False device configuration.
		1 Flashing	Local error.
		2 Flashings	Timeout Watchdog Process Data. Timeout Watchdog EtherCAT.
		Off	No error.
OUT SUPPLY		On	Power supply on (24VA). (Manifold and output power supply).
		Off	No power supply (24VA). (Manifold and output power supply).
L/A X1		On	EtherCAT connection on channel IN.
		Flashing	Message Transmission/Receipt on channel IN.
		Off	No Message Transmission/Receipt on channel IN.
L/A X2		On	EtherCAT connection on channel OUT.
		Flashing	Message Transmission/Receipt on channel OUT.
		Off	No Message Transmission/Receipt on channel OUT.

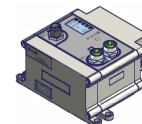





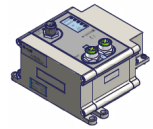



Error codes - Profinet, EtherNet/IP, EtherCAT















	Color	Status	Meaning
ON/Diag		1 Flashing	Lack of general power supply (24VA).
		2 Flashings	One or more output are in short circuit or overloaded.
		3 Flashings	Attention, high level of disturbance.
		4 Flashings	Module error (one or more modules are not working).
		5 Flashings	No inputs or outputs module detected.
		6 Flashings	Reserved (WDT).
		7 Flashings	Reserved.
		8 Flashings	Reserved (IO Configuration Fail).
		9 Flashings	Lack of supply +24V for input (overload)
		10 Flashings	Lack of module power supply.
		11 Flashings	Reserved (EEPROM Fail).
		12 Flashings	Electric clamp in error.
		13 Flashings	Short circuit or overload on the outputs of the electric clamps.
		1 Flashing	Reserved (FW Cookie not valid).
		2 Flashings	Reserved (Map Channel not valid).
		3 Flashings	Reserved (FW not valid).
		4 Flashings	Reserved (Hand Shake Invalid).
		5 Flashings	Reserved (Configuration Failed).
		6 Flashings	Reserved (Lock Failed).
		7 Flashings	Reserved (Register Failed).
	8 Flashings	Reserved (Device Ready Timeout).	



LED Status and Diagnostics - Profibus

LED	Color	Status	Meaning
ON		On	Device supplied and ready.
		Off	No logic power supply (VLS24) or faulty device.
BF		On	Not configured system; no connection to the bus; Master not communicating.
		Flashing	No data exchange (Wrong master configuration).
		Off	No error.
OUT SUPPLY		On	Power supply on (24VA). (Manifold and output power supply).
		Off	Missing power supply (24VA). (Manifold and output power supply).
Diag		Flashing	Error, see error codes table for further details.
		Off	No error.

LED Status and Diagnostics - CANopen

Logic Status		On	Device supplied and ready.
		Off	No logic power supply (VLS24) or faulty device.
CAN Run/Err		On	Working (the device is correctly working)
		1 Flashing	Device status > STOP.
		Flashing	Pre-Operational status.
		Flickering	Auto Baurate or LSS
		On	Error on the device.
		1 Flashing	Frame error counter has reached the warning level.
		2 Flashing	"Heartbeat" or "Guard" event.
		3 Flashing	Timeout, SYNC message was not received on time.
	OUT SUPPLY		On
		Off	Missing power supply (24VA). (Manifold and output power supply).
Diag		Flashing	Error, see error codes table for further details.
		Off	No error.

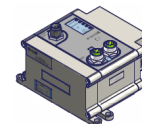





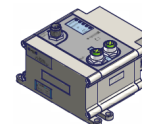



Error codes - Profibus and CANopen





	Color	Status	Meaning
Diag	●	1 Flashing	Lack of general power supply (24VA).
	●	2 Flashings	One or more output are in short circuit or overloaded.
	●	3 Flashings	Attention, high level of disturbance
	●	4 Flashings	Module error (one or more modules are not working).
	●	5 Flashings	No inputs or outputs module detected.
	●	6 Flashings	Not valid address or LSS device not configurated.
	●	7 Flashings	Reserved.
	●	8 Flashings	Reserved.
	●	9 Flashings	Lack of power supply +24V for inputs (overload).
	●	10 Flashings	Lack of module power supply
	●	11 Flashings	Reserved (EEProm Fail).
	●	12 Flashings	Electric clamp in error.
	●	13 Flashings	Short circuit or overload on the control outputs of the electric clamp.



LED Status and Diagnostics - IO-Link

LED	Color	Status	Meaning
C/Q		Flashing	Device supplied and communicating
		Off	No power supply or faulty device.
ERROR		Flashing	No data exchange, system not connected to the Master.
		Off	No error (if Flashing C/Q).
POWER		On	Valve power supply on (2L/2M).
		Off	No valve power supply (2L/2M).
Diag		Flashing	Error, see error codes table for further details.
		Off	No error present.

Error codes Table - IO-Link

	Color	Status	Meaning
Diag		1 Flashing	Missing valve power supply. (Pin 2 and 5 pf CN1 for TCxLNKB). (Pin 1 and 3 of CN2 for TCxLNKA).
		2 Flashings	One or more outputs are in short circuit or overloaded.
		4 Flashings	Module in error or not working.
		6 Flashings	Under voltage valve power supply. The voltage is lower than the set value.
		7 Flashings	Interrupted coil or open circuit.

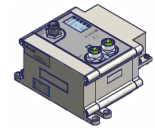

Configuration Parameters - Profinet

Here below one example by using “TIA Portal” software by Siemens.
Place the master in the window “Devices & Nets”

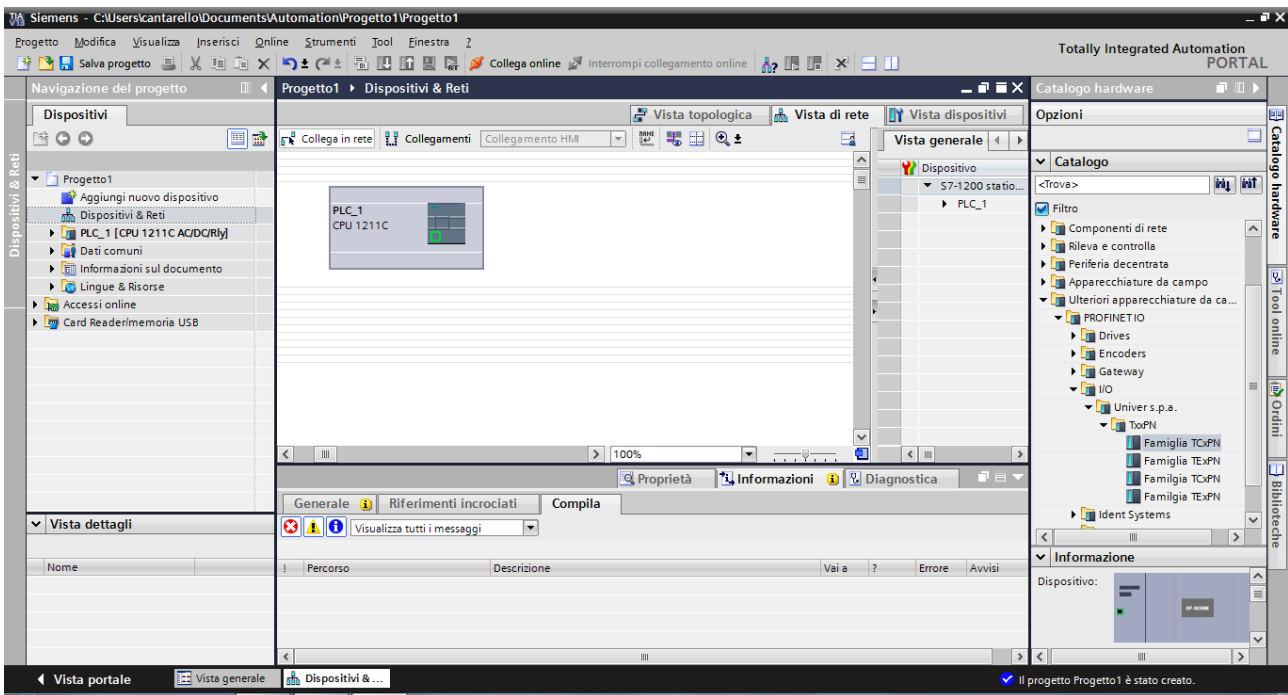

Import the GSDML device file from the CD or Internet website.
In “Hardware catalogue”, “Further Fieldbus devices” “I/O/PROFINET” “I/O” the folder “Univer S.p.A.” will appear.
Click the device from the list and put it into the window “Devices and Nets”.

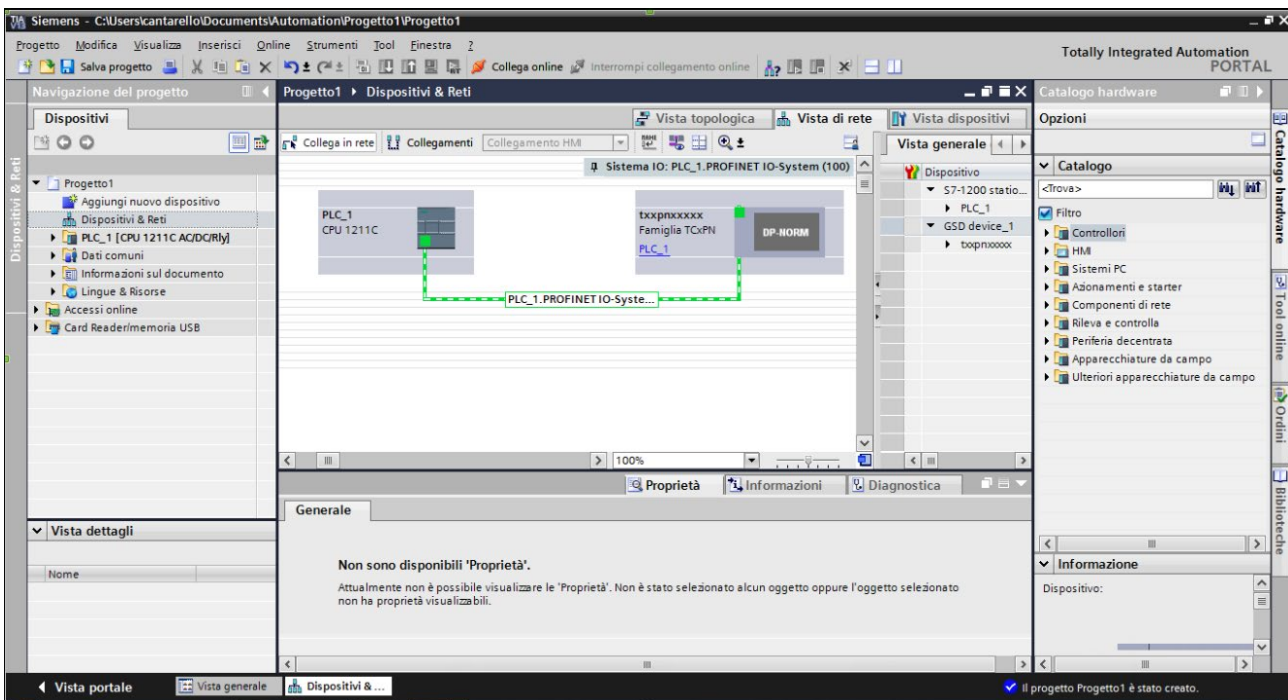

Connect the BUS between the master and the slave “green line”.

Allocate the IP address, the name and the other options/parameters needed for the application.



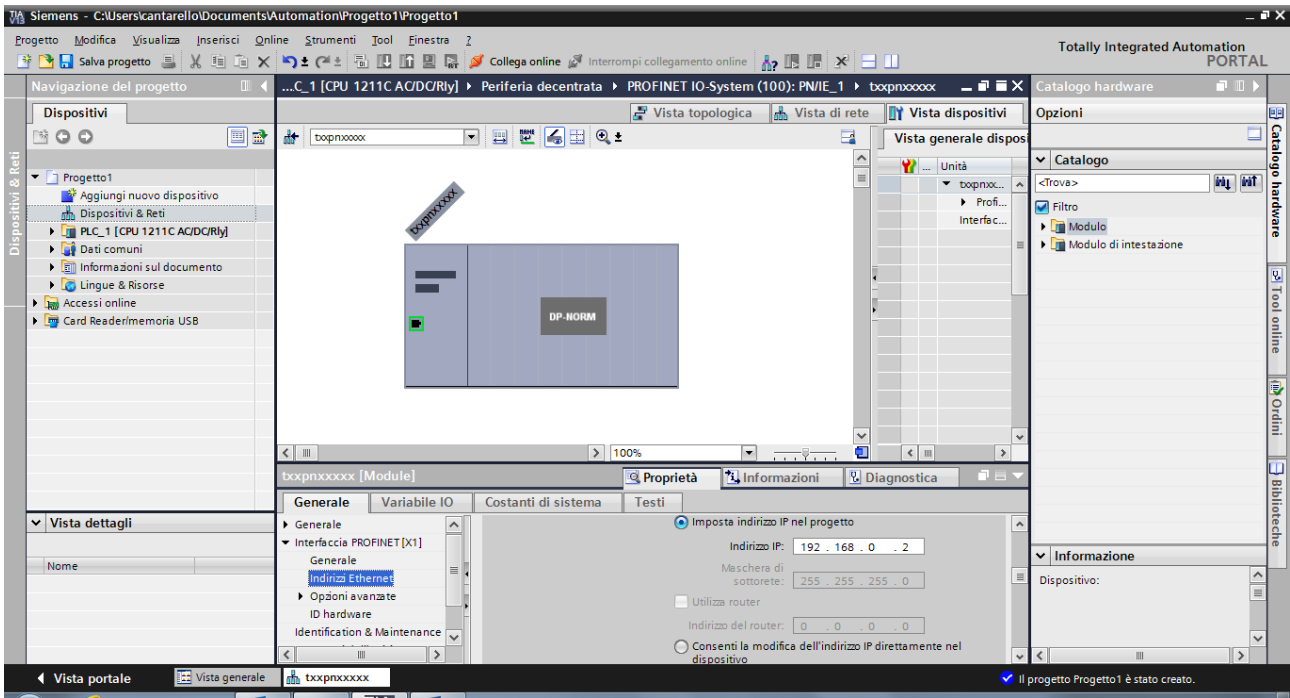
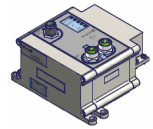

Put into the slots the different modules building the device and allocate the related addresses for the inputs and the outputs.

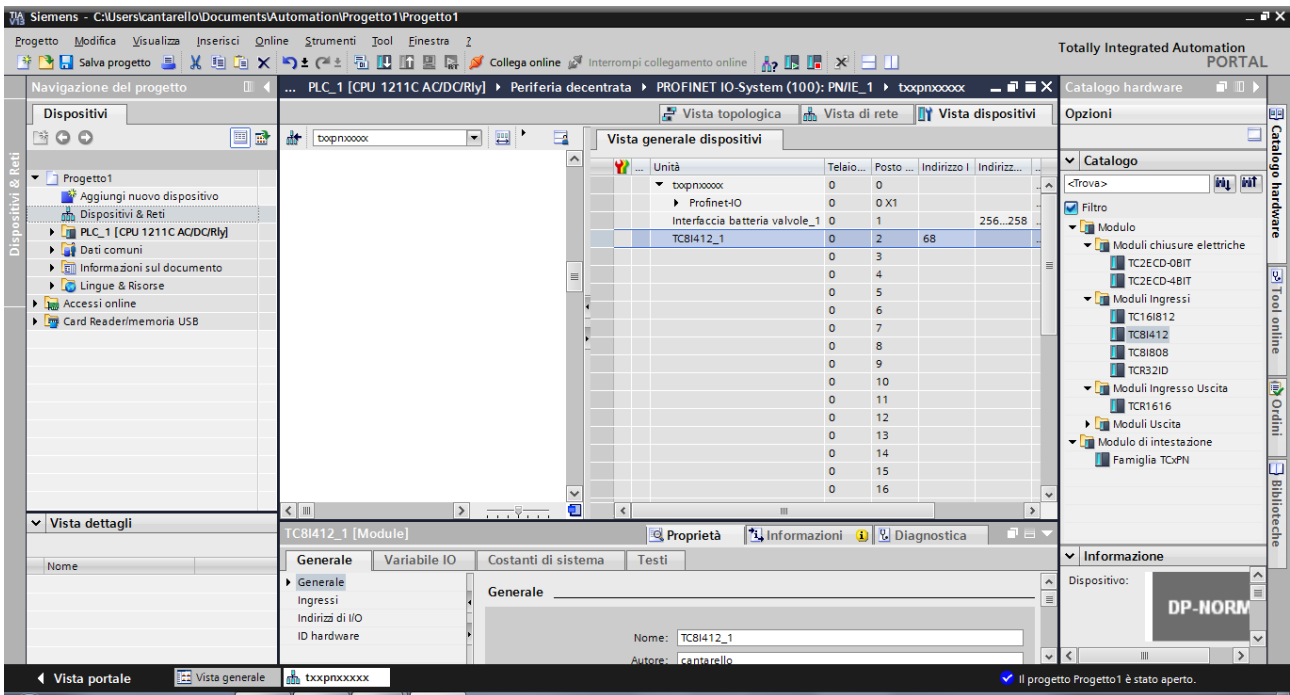

(in the example further to the integrated interface for the valve manifold, there is also an input module - 8 inputs M12)



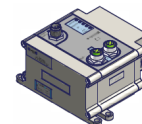

From the master configuration programme it is possible to enable or disable the creation of some errors, and set some device options.

If the option “Further module diagnostics” is disabled, no module error is generated.

Parameter table

Diag: Main Power Loss 24V	Enable or disable the creation of the diagnostics in case of lack of power supply for outputs (VA24).
Diag: Module Fail	Enable or disable the creation of the diagnostics in case of faulty module.
Diag: Output Fail	Enable or disable the creation of the diagnostics in case of overload or short circuit of the outputs.
Diag: High Noise Level	Enable or disable the creation of the diagnostics in case of high level of noise.
Diag: Input Power Loss 24V	Enable or disable the creation of the diagnostics in case of lack of supply on the input modules.
Input response time	Low: Environment Input filter very disturbed (> 50mS). Fast: Max. input sampling rate (< 50mS). The response time depends on the number of inputs and outputs of the system. Default: Low.
Further module diagnostics	If enabled one diagnostics for each module will be created.
Mode manifold first	If True, the integrated manifold will use the first 3 bytes of the allocated address. If False, the integrated manifold will use the last 3 bytes of the allocated address.
What to do in case of CPU STOP	Select the desired behaviour in case of master CPU STOP. “Switch off the outputs” if you want to switch off automatically all the outputs. “Keep the last value” if you want to keep all the outputs like they were in the latest status. (in that case pay attention to the dangerous conditions that may be generated in the system). Default “Switch off all the outputs”.
Diag: Power Clamp Fail	Enable or disable the creation of a diagnostics in case of error by the electric power clamp (FAIL output of the power clamp activated).
Diag: Power Clamp Control Command Fail	Enable or disable the creation of a diagnostics in case of overload or short circuit of one or more outputs on one or more power clamp control output.
Power Clamp Lag time	Delay between the control of one electric power clamps to the following one (25...400mS in steps of 25mS). Default: 150mS.
Simultaneous Power Clamp	Number of power clamps that may be activated in the same moment (1...8). Default: 8.

Nota: if not configured, all the functions are enabled.

The procedure to modify the configuration parameters depends on the used master software. In the following page you can see an example of the menu shown in “Unit parameters” of the software “TIA Porta” di Siemens.

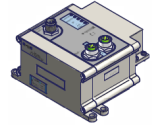

txxpnxxxxx [Module] Proprietà Informazioni

Generale | Variabile IO | Costanti di sistema | Testi

▸ Generale
 ▸ Interfaccia PROFINET [X1]
 Identification & Maintenance
Parametri dell'unità
 Indirizzi di diagnostica

Parametri dell'unità

Parametri

Diag.: Mancanza 24V attuatori:	Abilitato
Diag.: Modulo guasto:	Abilitato
Diag.: Uscita in errore:	Abilitato
Diag.: Livello di rumore elevato:	Abilitato
Diag.: Mancanza 24V Ingressi:	Abilitato
Tempo di risposta Ingressi:	Lento
Ulteriore diagnostica dal modulo:	Abilitato
Batteria Valvole per prima:	Vero
Comportamento in caso di STOP della CPU:	Spegni le uscite
Diag.: Chiusura Elettrica in errore:	Abilitato
Diag.: Errore comando Chiusura Elettrica:	Abilitato
Tempo Sfasamento Chiusure Elettriche:	150
Chiusure Elettriche contemporanee:	8

(example from TIA Portal V13)

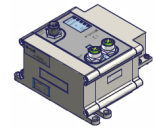

Error codes of the Profinet diagnostics messaging

The device can generate the following diagnostics messages::

<i>DIAGNOSTICS CODE</i>		
<i>Error Code</i>	<i>Name</i>	<i>Description</i>
256	Lack of output 24V	Lack of 24VA supply (pin 4 of the supply connector). In such a condition the coils are not supplied even if the outputs are activated..
257	Lack of input 24V	Overload or short circuit in one or more connectors of the input module.
258	Attention: high level of noise	Communication error on the internal device bus, caused by high noise level (bad cabling, lack of grounding or capacitive coupling of the cables).
259	Damaged module	Module error (module to be changed).
260	One or more outputs are overloaded or in short circuit	One or more outputs of the auxiliary output module are overloaded or in short circuit, see note (1) .
261	Electric Clamp in error	Error in the electric clamp (power clamp FAIL output is active).
262	Electric Clamp control output is overloaded or in short circuit	One of the control outputs of the electric clamp is overloaded or in short circuit.

If the option “Further Module Diagnostics” is enabled, an error message is generated for each sub-module (Slot 1...17), if it is disabled one single error message is generated for the general module (Slot 0).

- (1)** If the error is caused by the integrated manifold, it is possible to reset the error by switching off all the 24 outputs, wait for at least 7 seconds and restart the needed output once again.
In case of short circuit or overload all the 24 outputs are switched off.
- (2)** On output module.

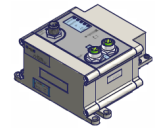

Configuration Parameters - EtherNet/IP

Here below one example by using the software “Appicom Console”.

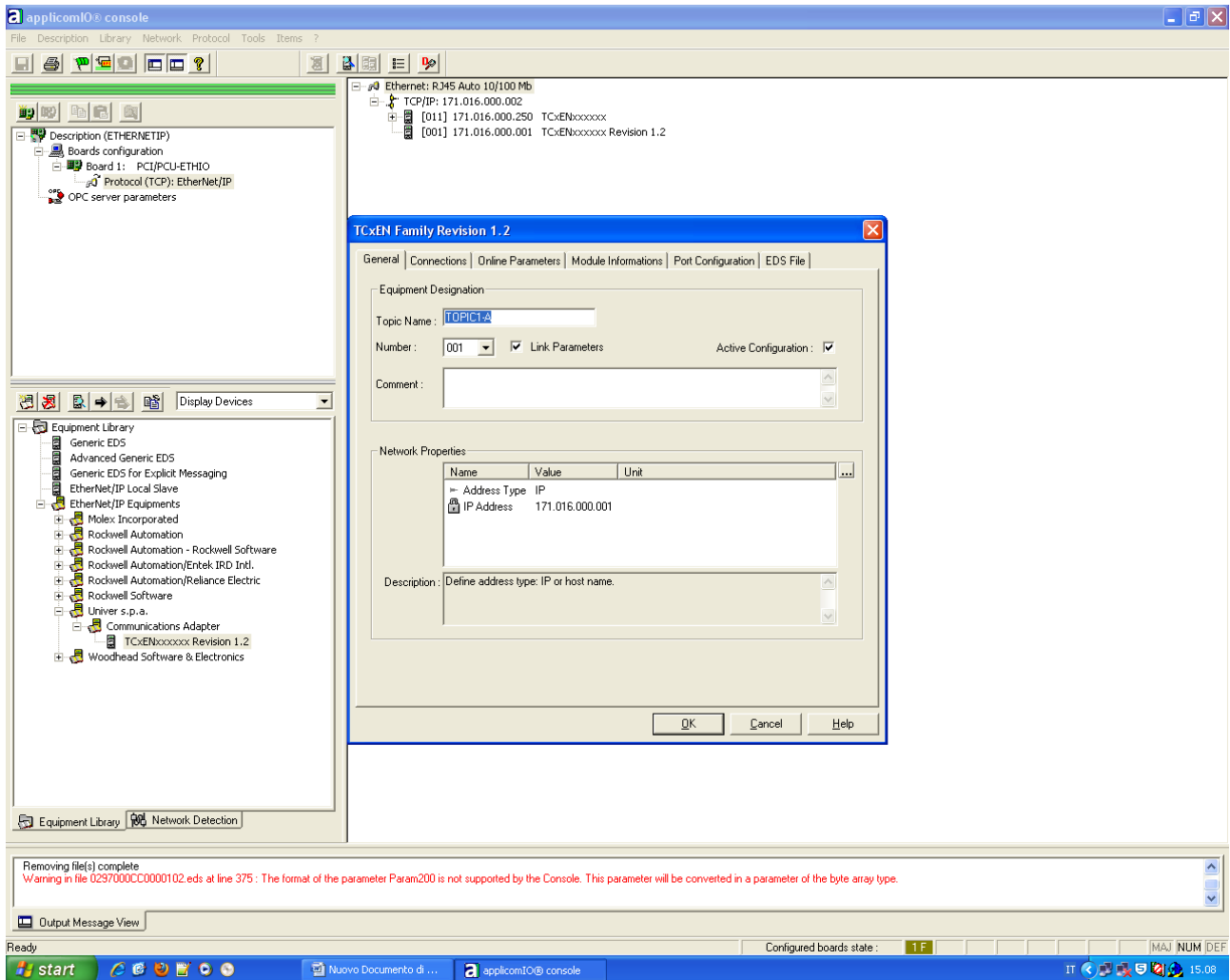

Import the EDS device file from the CD or Internet website.

In “Equipment Library”, “Ethernet/IP equipment” the folder “Univer S.p.A.” will appear.

Click the device from the list and put it into the right side of the window. Remember to assign the IP address to the device (it must be in the same as that of the master network) if the DHCP is not active.



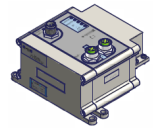

Set the same address of the device.

TCxEN Family Revision 1.2

General | Connections | Online Parameters | Module Informations | Port Configuration | EDS File

Equipment Designation

Topic Name : TOPIC1-A

Number : 033 Link Parameters Active Configuration :

Comment :

033
034
035
036
037
038
039
040
041

Network Prop

name	Value	Unit
▶ Address Type	IP	
🔒 IP Address	171.016.000.033	

Description : Define address type: IP or host name.

OK Cancel Help

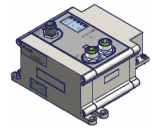

Now configure the number of bytes for the inputs and the number of bytes for the output of the used device.
(in the example we have a TCxEN and only 3 bytes for the output will be assigned).

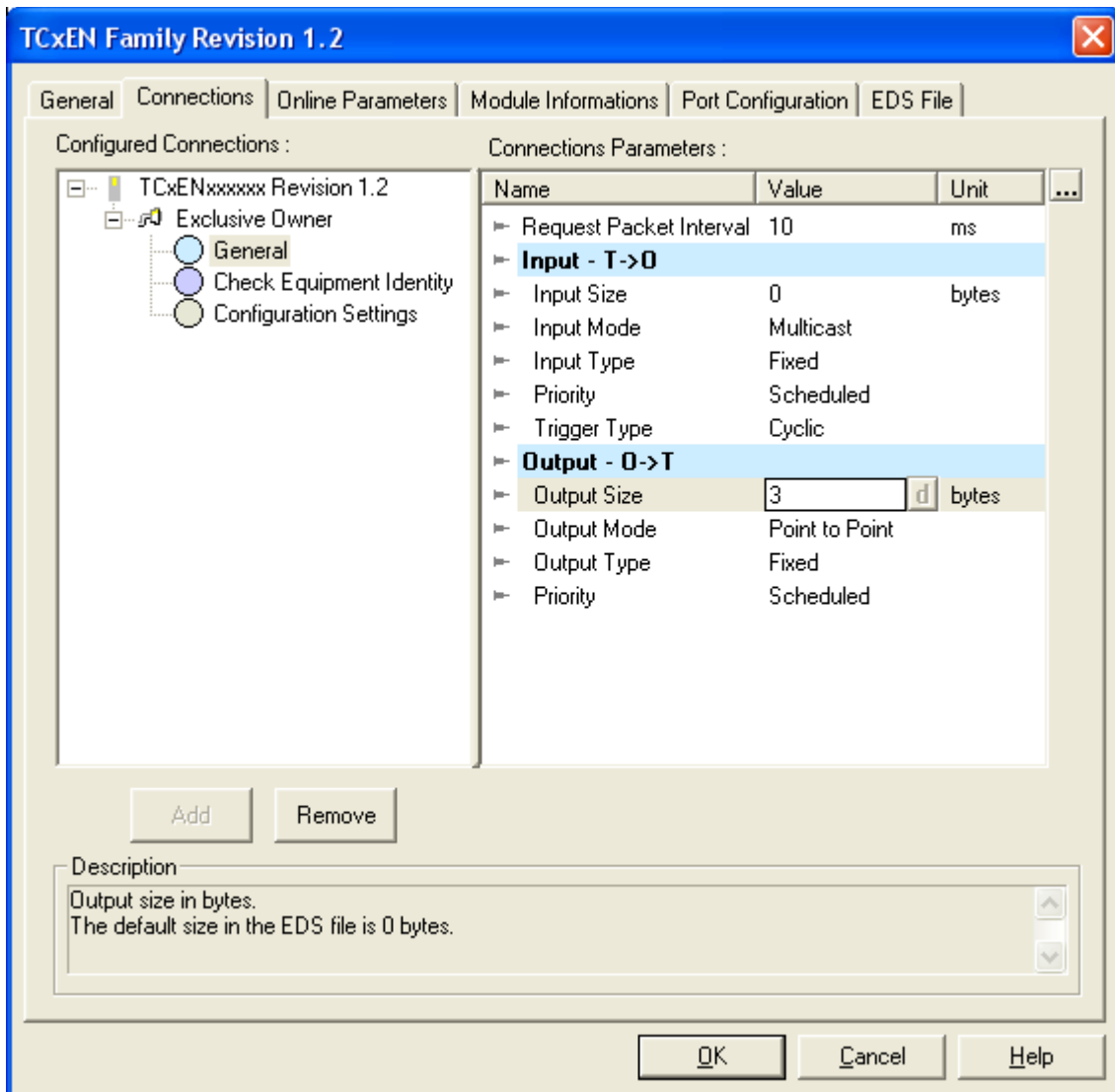

The procedure may be slightly different in different software, however the operative sequence must be generally the following:

- 1) Set the IP address (not necessary if the DHCP is activated) and the other options by using the BootP software or the Ethernet/IP Device Configurator.
- 2) Set the device EDS file in the master.
- 3) Scan the network or insert the device by selecting it from the list and put it into the window with the master.
- 4) Configure the number of bytes for inputs and outputs.
- 5) Configure the options of the module if necessary.

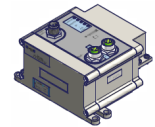

From the master configuration programme it is possible to enable or disable the creation of some errors, and set some device options.

If the option “Further module diagnostics” is disabled, no module error is generated.

Parameter table

Diag: Main Power Loss	Enable or disable the creation of the diagnostics in case of Power Loss for outputs (VA24).
Diag: Module Fail	Enable or disable the creation of the diagnostics in case of module failure
Diag: Output Fail	Enable or disable the creation of the diagnostics in case of overload or short circuit of the outputs.
Diag: High Noise Level	Enable or disable the creation of the diagnostics in case of high noise level.
Diag: Input Power Loss	Enable or disable the creation of the diagnostics in case of Input power loss.
Sample Rate	Slow: Environment Input filter very disturbed (> 50mS). Fast: Max. input sampling rate (< 50mS). The response time depends on the number of inputs and outputs of the system. Default: Slow.
Mode Manifold First	If True, the integrated manifold will use the first 3 bytes of the allocated address. If False, the integrated manifold will use the last 3 bytes of the allocated address.
Fault Action Option	Select the desired behaviour in case of master CPU STOP. “Turn Output Off” if you want to turn off automatically all the outputs. “Keep Last Value” if you want to keep all the outputs as they were in the latest status. (in that case pay attention to the dangerous conditions that may be generated in the system). Default: “Turn Output Off”.
Extended Module Diag	If enabled, a diagnostics for each extended module will be created.
Diag: Electric Clamp Fail	Enable or disable the creation of a diagnostics in case of error by the electric power clamp (FAIL output of the power clamp activated).
Diag: Electric Clamp command Fail	Enable or disable the creation of a diagnostics in case of overload or short circuit on one or more command output of the electric clamp.
Electric Clamp Lag Time	Delay time between the control of one power clamp and the following one (25...400mS in steps of 25mS). Default: 150mS.
Simultaneous Electric Clamp	Number of power clamps that may be activated in the same moment (1...8). Default 8.

Note: if not configured, all the functions are enabled.

The procedure to modify the configuration parameters depends on the used master software. In the following page you can see an example of the many shown in “Online Parameters” of “Applicom Console”.

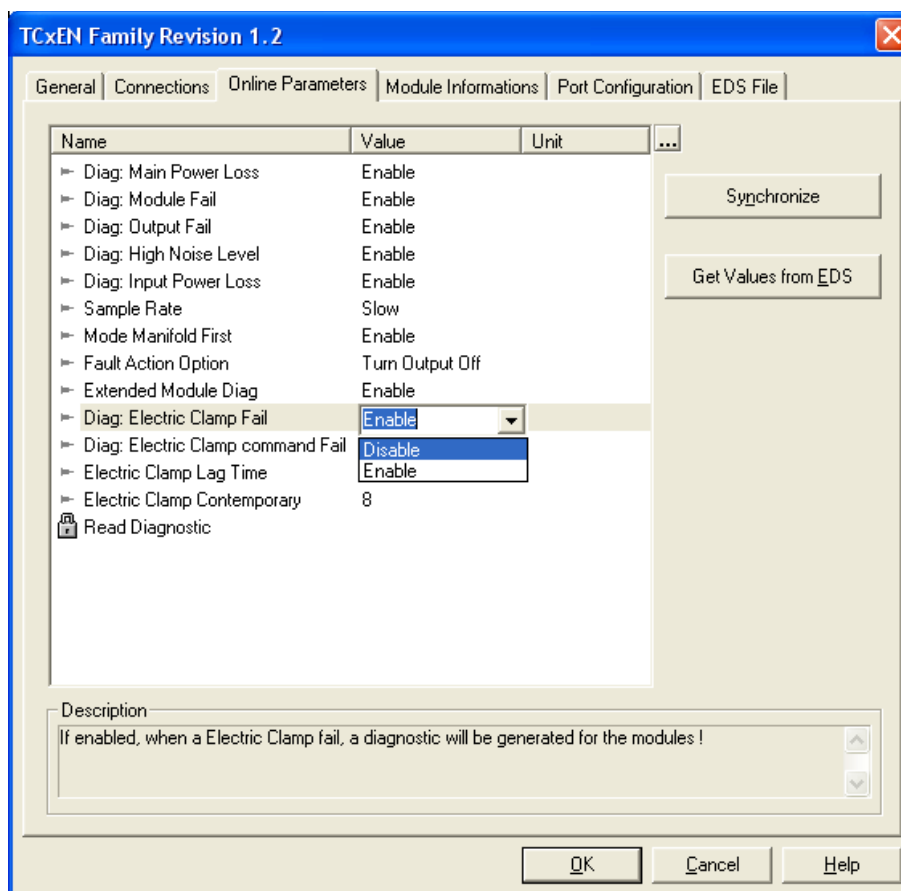
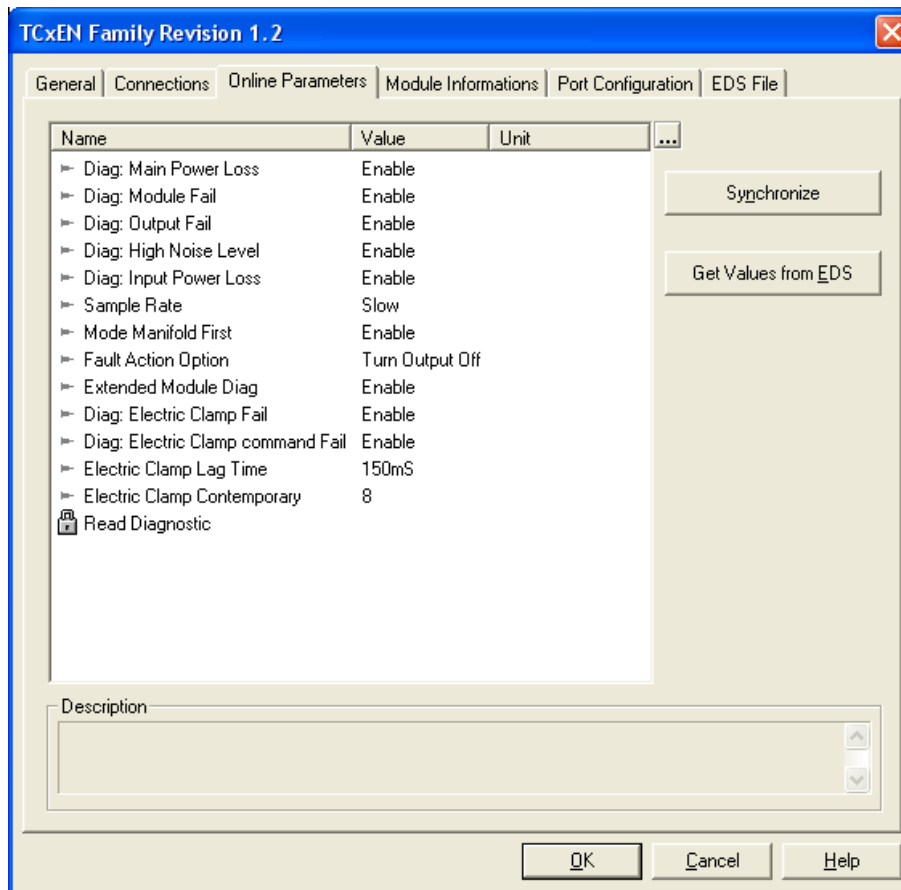
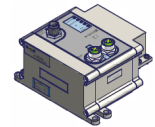

(example from Applicom Consolle V3.2)

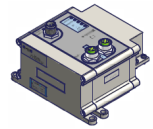

One the desired options are selected, click “Synchronize” to send the configuration to the device.

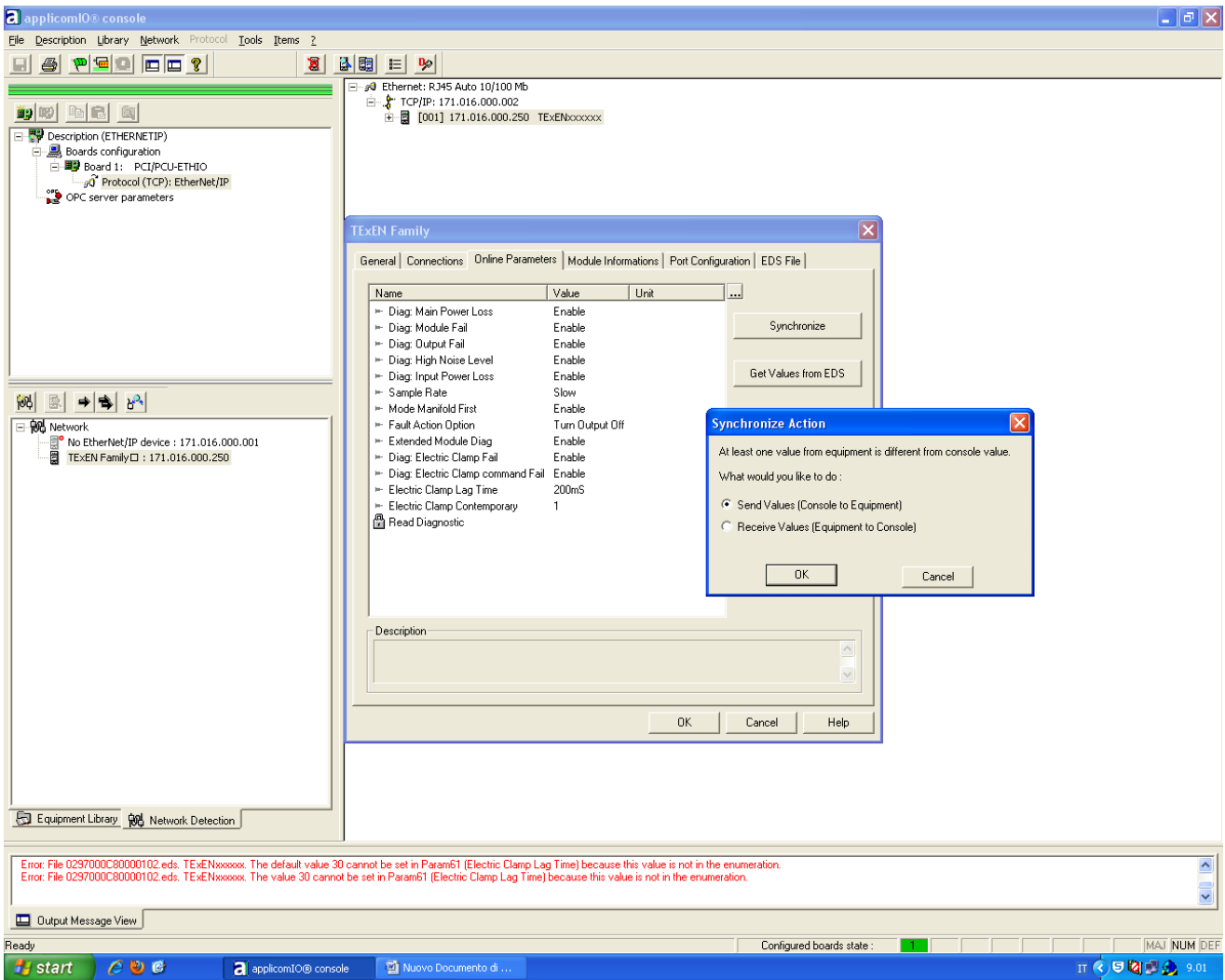

Be sure that “Send Values” is ticked and click “OK”.

If the procedure is correctly received by the device, a message like the following one will appear.



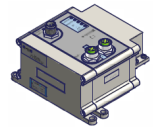

The screenshot shows the 'applicomIO console' interface. The main window displays the configuration for a device, including the 'TEXEN Family' dialog box. The dialog box has several tabs: 'General', 'Connections', 'Online Parameters', 'Module Informations', 'Port Configuration', and 'EDS File'. The 'Online Parameters' tab is active, showing a table of diagnostic parameters:

Name	Value	Unit
Diag: Main Power Loss	Enable	
Diag: Module Fail	Enable	
Diag: Output Fail	Enable	
Diag: High Noise Level	Enable	
Diag: Input Power Loss	Enable	
Sample Rate	Slow	
Mode Manifold First	Enable	
Fault Action		
Extended M		
Diag: Electr		
Diag: Electr		
Electric Clat		
Electric Clat		
Read Diagn		

A message box titled 'applicomIO Console' is displayed over the dialog, stating: 'The Console values are successfully sent in the equipment.' with an 'OK' button.

At the bottom of the console, an 'Output Message View' shows the following error messages:

```
Error: File 0297000C80000102.eds: TEXENxxxxx: The default value 30 cannot be set in Param61 (Electric Clamp Lag Time) because this value is not in the enumeration.
Error: File 0297000C80000102.eds: TEXENxxxxx: The value 30 cannot be set in Param61 (Electric Clamp Lag Time) because this value is not in the enumeration.
13 parameters have been set in the device.
```

Now the configuration is permanently saved inside the device and will be used also for next reboot or power ups.

If you want to know the current configuration of the device, click “Synchronize” , tick “Receive Values” and click “OK”.
So the current options of the device will be uploaded.

As alternative you can you the following function:

Service: **Set Attribute Single**
 Class: **100 (64 hex)**
 Instance: **1**
 Attribute: **1...13 (01..0D hex)**



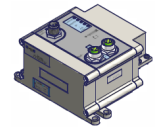

Error codes of the EtherNet/IP diagnostics messaging

Use the following to get diagnostic information:

Service: **Get Attribute Single**
 Class: **101 (65 hex)**
 Instance: **1**
 Attribute: **1**

The device will respond with 18 bytes; the first byte of them is the main diagnostics, while the further 17 bytes are the extended diagnostics of the possible manageable modules.

Byte																	
1	2	3	4	5	6	7	8	9	10	11	12	13	14	15	16	17	18
Main Diag.	Valves Slot	Slot 1	Slot 2	Slot 3	Slot 4	Slot 5	Slot 6	Slot 7	Slot 8	Slot 9	Slot 10	Slot 11	Slot 12	Slot 13	Slot 14	Slot 15	Slot 16

BITS OF THE MAIN DIAGNOSTICS		
Bit	Name	Description
0	24V Main power loss	This bit at 1 indicates the lack of the VA24 power supply (pin4 of the power connector). In this condition the valve coils will not be powered even if the command is active.
1	Module fail	This bit at 1 indicates that the module is faulty (replace the module).
2	Output fail	This bit at 1 indicates that one or more outputs are overloaded or in short circuit, this applies both to the integrated manifold and to the output modules (1).
3	High noise level	This bit at 1 indicates that a communication error has been detected on the internal bus, caused by the high level of noise, due to bad wiring, lack of grounding, or capacitive coupling of the connecting cables.
4	Input power loss	This bit at 1 indicates an overload or a short circuit in one or more connectors of the input module.
5	Reserved	For future use.
6	Clamp Error	This bit at 1 indicates that one or more electric clamps are in error.
7	Module info Monitor	This bit at 1 indicates that an extended module diagnostics is available.

NIBBLE OF THE EXTENDED DIAGNOSTICS	
Binary	Description
0000	This value indicates that no error is present.
0001	This value indicates the lack of power supply (VA24). (2)
0010	This value indicates that one or more outputs are overloaded or in short circuit. (2)
0011	This value indicates that a communication error has been detected on the internal bus, caused by a high level of noise, due to bad wiring, lack of grounding, or capacitive coupling of the connection cables.
0100	This value indicates a module failure.
0101	This value indicates an overload or short circuit in one or more connectors of the input modules.
0110	This value indicates that one or more electric clamps are in error (FAULT output active).
0111	This value indicates that one or more control outputs for the electric clamps are overloaded or in short circuit.
1000 - 1111	Not yet assigned.

The high nibble is always equal to 0, except for the TCR32xD and TCR1616 modules (discontinued), where the low nibble identifies the channel 0 (first connector A-C) and the high nibble identifies the channel 1 (second connector B-D).

If "Extended Module Diag" is disable, all the extended bytes (2-18) will be always equal to 0.

- (1) If the error is generated by the integrated manifold, it is possible to reset the error by turning off all the 24 outputs, wait for at least 7 seconds, and reactivate the needed outputs again.
 In case of short circuit or overload, all the 24 outputs will be switched off.
- (2) Only on output modules.



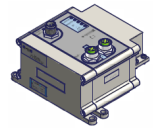

Configuration parameters - EtherCAT

Here below an example by using the softwar “TwinCAT” by Beckhoff”.

Copy into the installation directory “C:\.....\TwinCAT\IO\EtherCAT”, the ESI file of the device found on the CD or on the Internet website.

Start “TwinCAT System Manager” and add a new “Box” in the section “I/O Devices” “EtherCAT Devices”, by pressing the right mouse button on the item.

The screenshot shows the TwinCAT System Manager interface. On the left, a tree view shows the configuration structure under 'Dispositivi I/O'. A context menu is open over 'Dispositivo 2 (EtherCAT)', with 'Aggiungi box...' selected. The main window displays the configuration for 'Dispositivo 2 (EtherCAT)' with the following details:

- Nome: Dispositivo 2 (EtherCAT) Id: 2
- Tipo: EtherCAT
- Commento: (empty)
- Disabled
- Crea simboli

At the bottom, a table lists the configured boxes:

Nome box	Indirizzo	Tipo	Grand...	Grand...	E-Bus (mA)
Terminale 1 (EK1200)		EK1200			
Terminale 2 (EK1110)	1001	EK1110			1870

The Windows taskbar at the bottom shows the system tray with the date and time: 8.58.



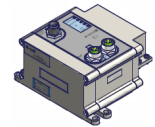

Select from the list “Univer S.p.A.” “TxxEC Family” the desired device, set the name and press OK.

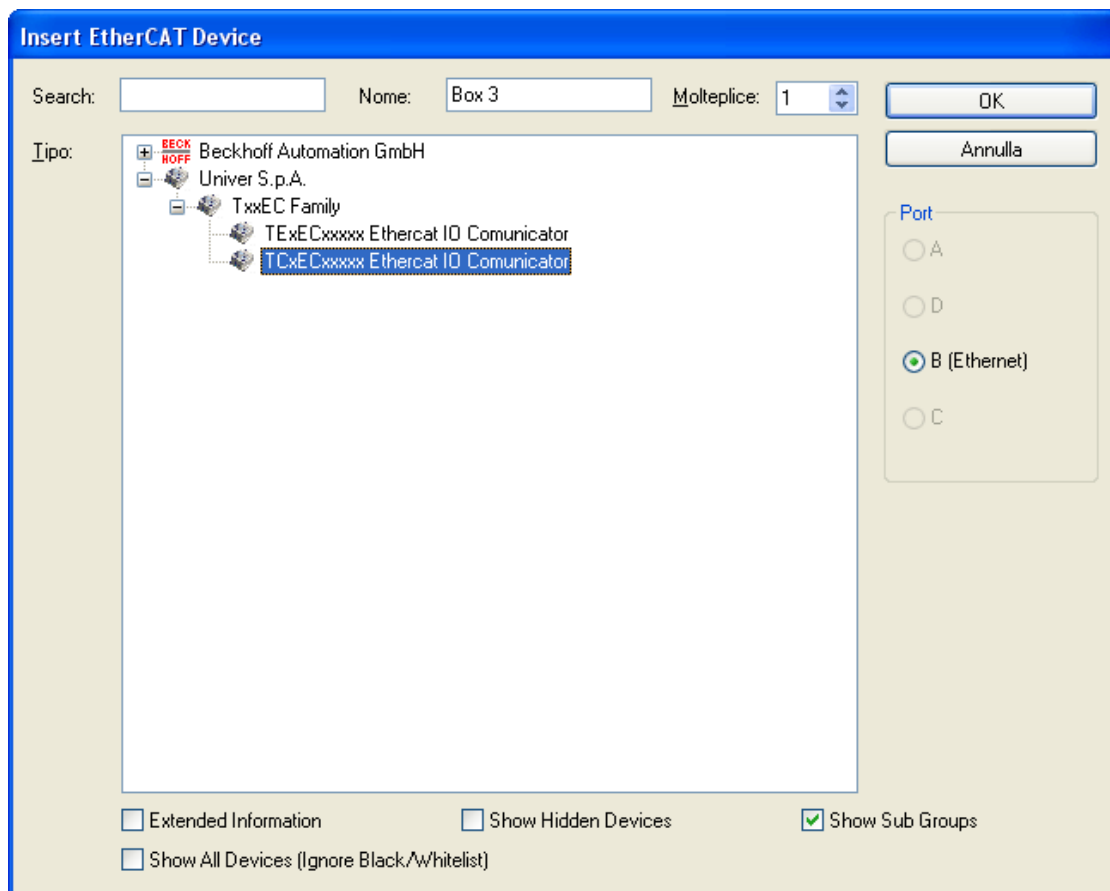

If “Univer S.p.A.” does not appear, try ticking “Show All Devices (Ignore Black/Whitelist)”.

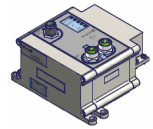

Press the right mouse button on the device just added and add the various modules that make up the system, choosing them from the list that will appear. (see next page).

The screenshot shows the TwinCAT System Manager interface. On the left, a tree view shows the system configuration, including 'Dispositivo 3 (EtherCAT)' and 'Box 3 (TCxECxxxxx)'. A context menu is open over 'Box 3', listing options like 'Aggiungi box...', 'Aggiungi modulo...', 'Inserisci box...', 'Cancella Box...', 'Importa box...', 'Esporta Box...', 'Tagliare', 'Copia', 'Inserisci', 'Inserisci con collegamento', 'Disabled', 'Change to Compatible Type...', and 'Add to Hot Connect Groups...'. The main configuration area shows the 'Generale' tab with fields for Name, Type, and Comment. Below this is a table of modules:

Tipo	Gran...	>Indir...	Entr...	User...	Collegato a
BOOL	0.1	1522.1	Ingre...	0	
BOOL	0.1	1524.1	Ingre...	0	
UINT	2.0	1550.0	Ingre...	0	
AMSADDRESS	8.0	1552.0	Ingre...	0	
BYTE	1.0	39.0	Uscita	0	
1 Byte Out (1)	1.0	40.0	Uscita	0	
1 Byte Out (2)	1.0	41.0	Uscita	0	



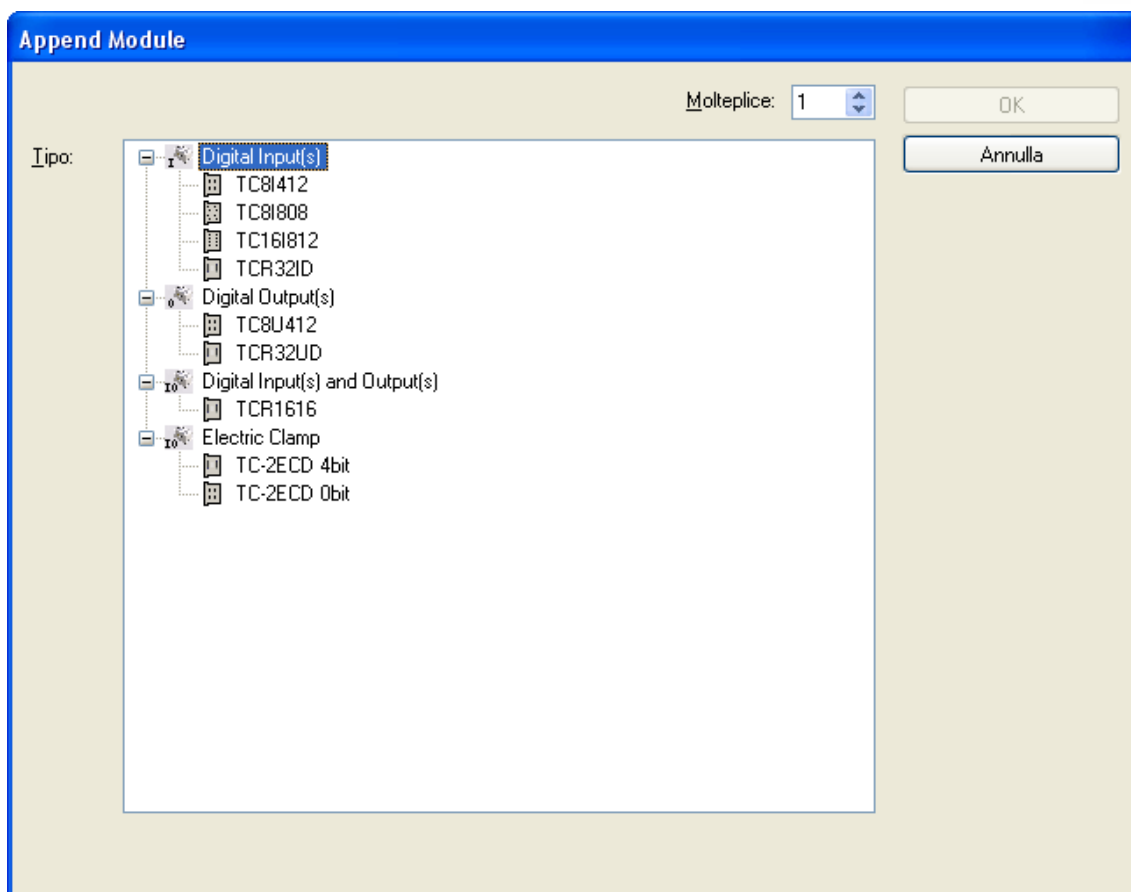
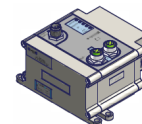

The above indications are just a rough indication of how to configure the device, for more details on the use of the software "TwinCAT", the various configuration possibilities and the related operating models, refer to the software manual.

The management of the configuration of the various parameters takes place via dictionary F800h and sub index from 1 to 14 (E in hexadecimal).

Dictionary	Sub index	Dunction	Admitted value
F800h	1	Diag: 24V Main Power Loss	0 = Disable – 1 = Enable
F800h	2	Diag: Module Fail	0 = Disable – 1 = Enable
F800h	3	Diag: Output Fail	0 = Disable – 1 = Enable
F800h	4	Diag: High Noise level	0 = Disable – 1 = Enable
F800h	5	Diag: 24V Input power loss	0 = Disable – 1 = Enable
F800h	6	Fast Input response time	0 = Slow – 1 = Fast
F800h	7	Mode Manifold First	0 = False – 1 = True
F800h	8	Turn off output on Fail	0 = False – 1 = True
F800h	9	Extended Diag.	0 = False – 1 = True
F800h	A	Diag: Electric Clamp Fail	0 = Disable – 1 = Enable
F800h	B	Diag: Clamp Command Fail	0 = Disable – 1 = Enable
F800h	C	Clamp LagTime	5..80 in steps of 5
F800h	D	Clamp Contemporary	1..8
F800h	E	Keep output on Safe OP	0 = Disable – 1 = Enable



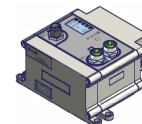

Parameters table

Diag: 24V Main Power Loss	Enables or disables the generation of the diagnostics in case of a power failure for the outputs (VA24).
Diag: Module fail	Enables or disables the generation of the diagnostics in case of module failure.
Diag: Output fail	Enables or disables the generation of the diagnostics in case of overload or short circuit of the outputs.
Diag: High Noise level	Enables or disables the generation of the diagnostics in case of detection of a high level of noise.
Diag: 24V Input power loss	Enables or disables the generation of the diagnostics in case of a power failure on the input modules.
Fast Input response time	Slow: input filter for very noisy environment (> 50mS). Fast: Maximum sampling frequency of the inputs (< 50mS). The time depends on the number of inputs and outputs of the system. Default Slow.
Mode Manifold First	If True, the integrated manifold will use the first 3 bytes of the assigned address. If False, the integrated manifold will use the last 3 bytes of the assigned address.
Turn off output on Fail	Select the desired behaviour in case of master CPU ALT or loss of communication. Able if you want to turn off all outputs automatically. Disable if you want to leave all the outputs in the last state. (in this case pay attention to the dangerous conditions that may be generated in the system). Default "Able"
Diag: Other Module info	If Able a diagnostics will be generated for each sub module.
Diag: Electric Clamp Fail	Enables or disables the generation of diagnostics in case of an error signal from the electric clamp (FAIL output of the electric clamp).
Diag: Clamp Command Fail	Enables or disables the generation of diagnostics in case of overload or short circuit of one or more control outputs of the electric clamp.
Clamp Lag time	Indicate the lag time between the command of an electric clamp and the next one (multiplicative coefficient of 5ms). Default 30 = 150mS.
Clamp Activated at the same Time	Indicates the number of clamps that can be activated at the same time (1...8). Default 8.
Keep output on Safe OP	Select the desired behaviour in case of module SAFE OP status. DisAble if you want to automatically turn off all the outputs. Able if you want to leave all the outputs in the latest status. (in this case pay attention to the dangerous conditions that may be generated in the system). Default "DisAble".

Note: if not configured, all the diagnostics functions are enabled (once written they keep the latest configured value).

The procedure for modifying the configuration parameters depends on the master software used. On the next page you can see an example of the menu that appears in the "TwinCAT" software by Beckhoff.

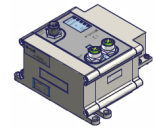

Error codes of the EtherCAT diagnostics messaging

The emergency message consists of 5 bytes with the data as shown below:

Composition of the emergency message

Byte	0	1	2	3	4
Content	Manufacturer specific error fields				
	Main Diagnostics	0000-0000	0000-0000	0000-0000	0000-0000
Module No.2					
Module No.1					
Module No.4					
Module No.3					
Module No.6					
Module No.5					
Module No.8					
Module No.7					

MANUFACTURER SPECIFIC ERROR FIELDS

BITS OF THE MAIN DISGNOSTICS (BYTE 0)

Bit	Name	Description
0	24V Main power loss	This bit at 1 indicated the lack of the VA24 power supply (pin4 of the power connector) In this condition the valve coils will not be powered even if the command is active.
1	Module fail	This bit at 1 indicates that the module is faulty (replace the module).
2	Output fail	This bit at 1 indicated that one or more outputs are overloaded or in short circuit, this applies both to the integrated manifold and for the output modules (1).
3	High noise level	This bit at 1 indicates that a communication error has been detected on the internal bus, caused by the high level of noise, due to bad wiring, lack of grounding or capacitive coupling of the connecting cables.
4	Input power loss	This bit at 1 indicates an overload or a short circuit in one or more connectors of the input module.
5	Clamp Error	This bit at 1 indicates that one or more electric clamps are in error.
6	Input modules or output modules	This bit at 0 indicates that the content of the message refers ot input modules. This bit at 1 indicates that the content of the messages refers to the output modules (3).
7	Module info Monitor	This bit at 1 indicates that an extended module diagnostics is available.

NIBBLES OF THE INPUT AND OUTPUT MODULES (BYTE 1....4)

Binary	Description
0000	This value indicates that no error is present.
0001	This value indicates the lack of power supply (VA24).
0010	This value indicates that one or more outputs are overloaded or in short circuit. (2)
0011	This value indicates that a communication error has been detected on the internal bus, caused by a high level of noise, due to bad wiring, lack of grounding, or capacitive coupling of the connection cables.
0100	This value indicates a module failure.
0101	This value indicates an overload or short circuit in one or more connectors of the input modules.
0110	This value indicates that one or more electric clamps are in error (FAULT output active).
0111	This value indicates that one or more control outputs for the electric clamps are overloaded or in short circuit.
1000 - 1111	Not yet assigned.

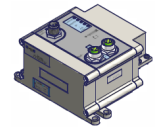

- (1) If the error is generated by the integrated manifold, it is possible to reset the error by turning off all the 24 outputs, wait for at least 7 seconds, and reactivate the needed outputs again.
In case of short circuit or overload all the 24 outputs will be switched off.
- (2) Only on output modules.
- (3) The type of emergency frame is 0x81 (Manufacturer Error + Generic Error), they are separated for inputs and outputs and are also generated when the cause of the error is removed.



Nota 1: The system generates an Emergency message in case one or more input modules are in error.

Nota 2: The system generates an Emergency message in case one or more output modules are in error.

Nota 3: The system generates two Emergency messages in case one or more input and output modules are in error.

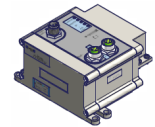

Configuration parameters - Profibus

Here below an example by using the software “Anybus NetTolol”.

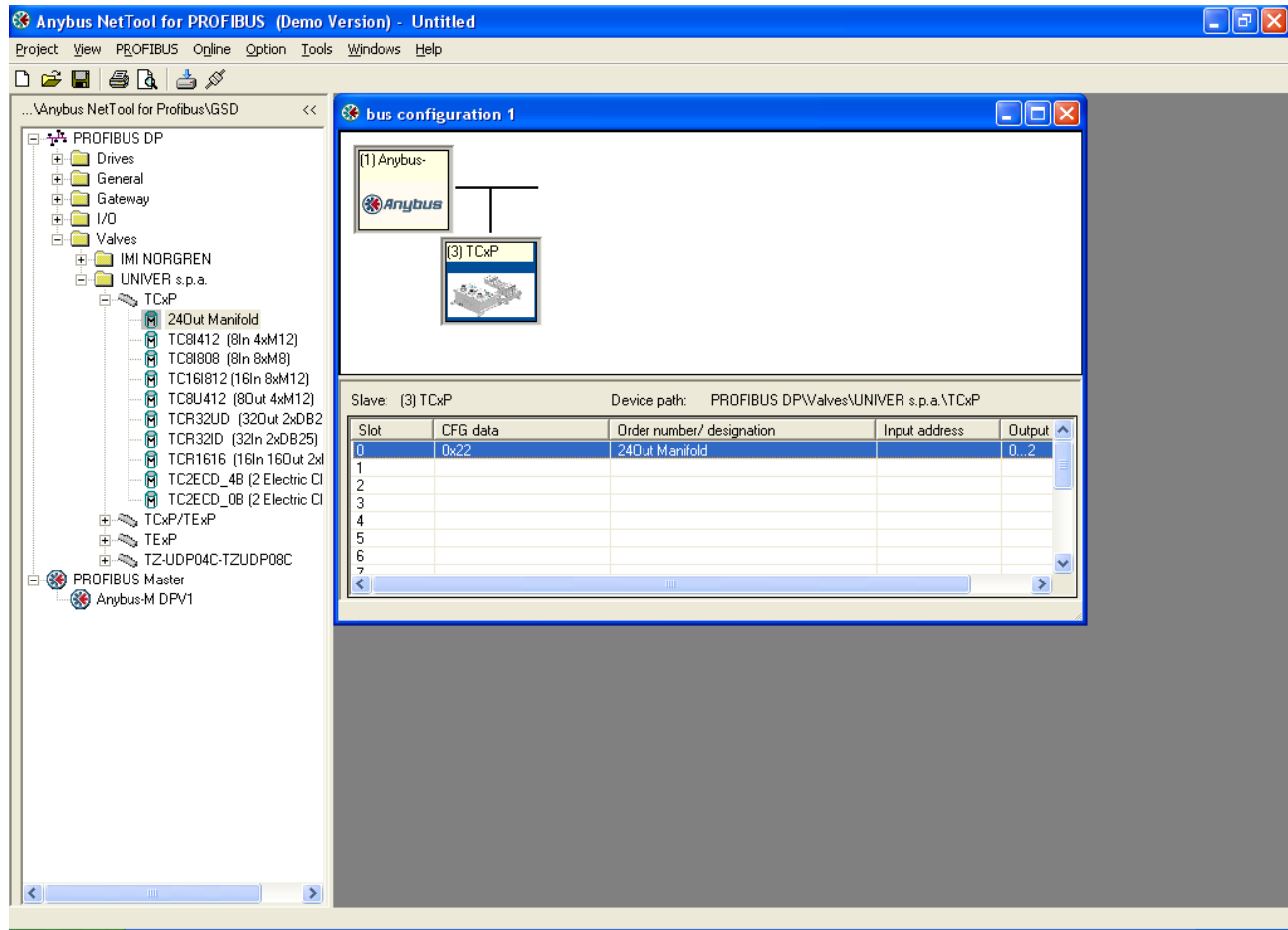

Slave: (3) TCxP Device path: PROFIBUS DP\Valves\UNIVER s.p.a.\TCxP

Slot	CFG data	Order number/ designation	Input address	Output
0	0x22	24Out Manifold		0...2
1				
2				
3				
4				
5				
6				
7				

Import the device GSD file that you find on the CD or on the website.

In the “PROFIBUS DP”, “Valves” the folder “Univer S.p.A.” should then appear.

Select the device “TCxP” or “TEXP” from the list and put it in the window on the right, connecting it to the Anybus master, assign the slave address and the various communication parameters.

Insert the various modules that make up the system in the slots (in the example a TCxP that has only the integrated interface for the manifold, which is assigned as visible in the slot 0).

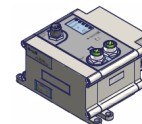

From the master configuration programme it is also possible to enable or disable the generation of some errors and to set some device options.

If the option “Other Module info” is disabled, no module extended error will be generated.

Parameters table

Diag: 24V Main Power Loss	Enable or disable the generation of the diagnostics in case of a power failure for the outputs (VA24).
Diag: Module fail	Enable or disable the generation of the diagnostics in case of module failure.
Diag: Output fail	Enable or disable the generation of the diagnostics in case of overload or short circuit of the outputs.
Diag: High Noise level	Enable or disable the generation of the diagnostics in case of detection of a high level of noise.
Diag: 24V Input power loss	Enable or disable the generation of the diagnostics in case of a power failure on the input modules.
Input response time	Slow: input filter for very noisy environment (> 50mS). Fast: Maximum sampling frequency of the inputs (< 50mS). The time depends on the number of inputs and outputs of the system. Default Slow.
Mode Manifold First	If True, the integrated manifold will use the first 3 bytes of the assigned address. If False, the integrated manifold will use the last 3 bytes of the assigned address.
Diag: Other Module info	If Able a diagnostics will be generated for each sub module.
Clamp Lag time	Indicates the lag time between the command of a electric clamp and the next one (25...400mS in steps of 25mS). Default 150mS.
Clamp Activated at the same Time	Indicates the number of clamps that can be activated in the same moment (1...8). Default 8.

Note: if not configured, all the diagnostics functions are enabled.

The procedure for modifying the configuration parameters depends on the master software used.

In the next page you can see an example of the menu that appears in “Anybus Tools” “Slave Properties” “Parameter assignment”.

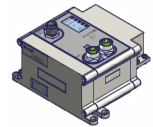

Slave properties - TCxP

Common | **Parameter assignment**

Module data:

Parameter	Value
Diag.: 24V Main power loss	enable
Diag.: Module fail	enable
Diag.: Output fail	enable
Diag.: High Noise level	enable
Diag.: 24V Input power loss	enable
Input response time:	slow
Mode Manifold First:	enable
Diag.Other Module info:	enable
Clamp Lag Time:	150
Clamp Activated at same Time:	8

User prm data:

001	002	003	004	005	006
00	00	00	DF	05	07

OK Cancel Help

Slave properties - TCxP

Common | **Parameter assignment**

Module data:

Parameter	Value
Diag.: 24V Main power loss	enable
Diag.: Module fail	disable
Diag.: Output fail	enable
Diag.: High Noise level	enable
Diag.: 24V Input power loss	enable
Input response time:	slow
Mode Manifold First:	enable
Diag.Other Module info:	enable
Clamp Lag Time:	150
Clamp Activated at same Time:	8

User prm data:

001	002	003	004	005	006
00	00	00	DF	05	07

OK Cancel Help

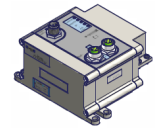

Error codes in the Profibus diagnostics messaging

The diagnostics includes 9 bytes which include all the possible errors of the various installable modules (8 input modules and 8 output modules).

The first byte is the main diagnostics. The next 8 bytes are the extended diagnostics and are divided into 4 bytes for the input modules and 4 bytes for the output modules. Each byte contains information of 2 modules, that is the extended diagnostics is divided into Nibbles.

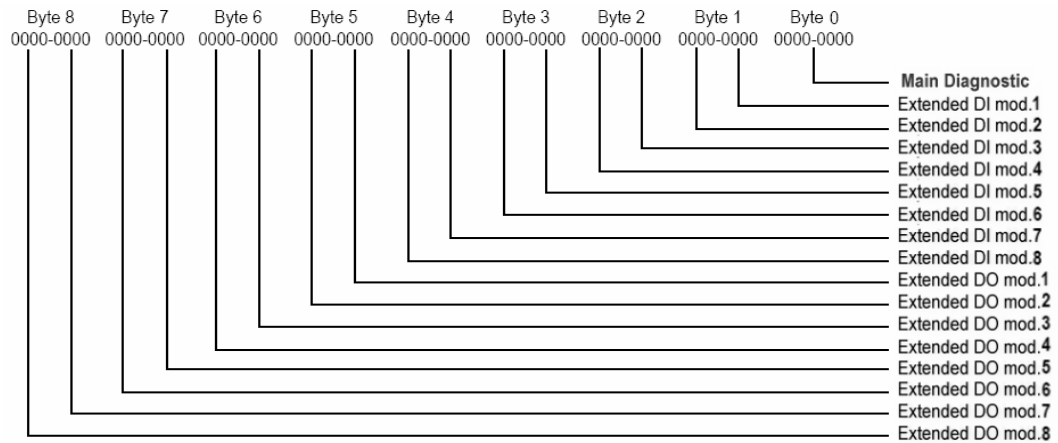

BITS OF THE MAIN DIAGNOSTICS

Bit	Name	Description
0	24V Main power loss	This bit at 1 indicates the lack of VA24 power supply (pin4 of the power connector). In this condition the valve coils will not be powered even if the command is active.
1	Module fail	This bit at 1 indicates that the module is faulty (replace the module).
2	Output fail	This bit at 1 indicates that one or more outputs are overloaded or in short circuit, this applies both to the integrated manifold and to the output modules (1).
3	High noise level	This bit at 1 indicates that a communication error has been detected on the internal bus, caused by the high level of noise, due to bad wiring, lack of grounding, or capacitive coupling of the connecting cables.
4	Input power loss	This bit at 1 indicates an overload or a short circuit in one or more connectors of the input module.
5	Clamp Error	This bit at 1 indicates that one or more electric clamps are in error.
6	Reserved	For future use.
7	Module info Monitor	This bit at 1 indicated that an extended module diagnostics is available.

NIBBLES OF THE EXTENDED DIAGNOSTICS

Binary	Description
0000	This value indicates that no error is present.
0001	This value indicates the lack of power supply (VA24). (2)
0010	This value indicates that one or more outputs are overloaded or in short circuit. (2)
0011	This value indicates that a communication error has been detected on the internal bus, caused by a high level of noise, due to bad wiring, lack of grounding, or capacitive coupling of the connection cables.
0100	This value indicates a module failure.
0101	This value indicates an overload or short circuit in one or more connectors of the input modules.
0110	This value indicates that one or more electric clamps are in error (output FAULT active).
0111	This value indicates that one or more control outputs for the electric clamps are overloaded or in short circuit.
1000 - 1111	Not yet assigned

- (1) If the error is generated by the integrated manifold, it is possible to reset the error by turning all the 24 outputs, wait for at least 7 seconds and reactivate the needed outputs again.
In case of short circuit or overload all the 24 outputs will be switched off.
- (2) Only on output modules.

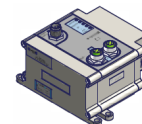

Configuration parameters - CANOPEN

The configuration management of the parameters is done through dictionary 2000h and sub index from 1 to 11 (B in hexadecimal).

Dictionary	Sub index	Function	Admitted value
2000h	1	Diag: 24V Main Power Loss	0 = Disable – 1 = Enable
2000h	2	Diag: Module Fail	0 = Disable – 1 = Enable
2000h	3	Diag: Output Fail	0 = Disable – 1 = Enable
2000h	4	Diag: High Noise level	0 = Disable – 1 = Enable
2000h	5	Diag: 24V Input power loss	0 = Disable – 1 = Enable
2000h	6	Fast Input response time	0 = Slow – 1 = Fast
2000h	7	Mode Manifold First	0 = False – 1 = True
2000h	8	Diag: Clamp Fail Diagnostic	0 = Disable – 1 = Enable
2000h	9	Diag: Clamp Cmd Diagnostic	0 = Disable – 1 = Enable
2000h	A	Clamp Time Lag	25..400 in steps of 25
2000h	B	Clamp Activated at the same Time	1..8

Parameters table

Diag: 24V Main Power Loss	Enables or disables the generation of the diagnostics in case of a power failure of the outputs (VA24).
Diag: Module fail	Enables or disables the generation of the diagnostics in case of module failure.
Diag: Output fail	Enables or disables the generation of the diagnostics in case of overload or short circuits of the outputs.
Diag: High Noise level	Enables or disables the generation of the diagnostics in case of detection of a high level of noise.
Diag: 24V Input power loss	Enables or disables the generation of the diagnostics in case of a power failure on the input modules.
Fast Input response time	Slow: input filter for very noisy environment (> 50mS). Fast: maximum sampling frequency of the inputs (< 50mS). The time depends on the number of inputs and outputs of the system. Default Slow.
Mode Manifold First	If True, the integrated manifold will use the first 3 bytes of the assigned address. If False, the integrated manifold will use the last 3 bytes of the assigned address.
Diag: Other Module info	If Enable a diagnostics will be generated for each sub module.
Clamp Lag time	Indicated the lag time between the command of and electric clamp and the next one (25...400mS in steps of 25mS). Default 150mS.
Clamp Activated at the same Time	Indicates the number of clamps that can be activated at the same time (1...8). Default 8.

Note: if not configured, all the diagnostics functions are enabled (once written they can keep the latest configured value).

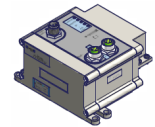

Error codes in the CANopen diagnostics messages

The emergency message consists of 8 bytes with the data shown below:

Composition of the emergency message									
Byte	0	1	2	3	4	5	6	7	
Content	Emergency error code		Error register (object 1001H)	Manufacturer's specific error fields					
				Main Diagnostics	0000-0000	0000-0000	0000-0000		
				Module No.2					
				Module No.1					
				Module No.4					
				Module No.3					
				Module No.6					
				Module No.5					
				Module No.8					
				Module No.7					

MANUFACTURER'S SPECIFIC ERROR FIELDS

BITS OF THE MAIN DIAGNOSTICS (BYTE 3)		
Bit	Name	Description
0	24V Main power loss	This bit at 1 indicates the lack of VA24 power supply (pin4 of the power connector). In this condition the valve coils will not be powered even if the command is active.
1	Module fail	This bit at 1 indicates that the module is faulty (replace the module).
2	Output fail	This bit at 1 indicates that one or more outputs are overloaded or in short circuit, this applies both to the integrated manifold and to the output modules (1).
3	High noise level	This bit at 1 indicates that a communication error has been detected on the internal bus, caused by the high level of noise, due to bad wiring, lack of grounding, or capacitive coupling of the connecting cables.
4	Input power loss	This bit at 1 indicates an overload or a short circuit in one or more connectors of the input module.
5	Clamp Error	This bit at 1 indicates that one or more electric clamps are in error.
6	Moduli di Ingressi o Moduli Uscite	This bit at 0 indicates that the content of the message refers to the input modules, this bit at 1 indicates that the content of the message refers to the output modules (3).
7	Module info Monitor	This bit at 1 indicates that an extended module diagnostics is available.

NIBBLES OF THE DIAGNOSTICS FOR INPUT AND OUTPUT MODULES (BYTE 4...7)	
Binary	Description
0000	This value indicates that no error is present
0001	This value indicates the lack of power supply (VA24). (2)
0010	This value indicates that one or more outputs are overloaded or in short circuit. (2)
0011	This value indicates that a communication error has been detected on the internal bus, caused by a high level of noise, due to bad wiring, lack of grounding, or capacitive coupling of the connection cables.
0100	This value indicates a module failure.
0101	This value indicates an overload or short circuit in one or more connectors of the input modules.
0110	This value indicates that one or more electric clamps are in error (output FAULT active).
0111	This value indicates that one or more control outputs for the electric clamps are overloaded or in short circuit.
1000 - 1111	Not yet assigned.

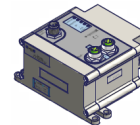

- (4) If the error is generated by the integrated manifold, it is possible to reset the error by turning all the 24 outputs, wait for at least 7 seconds and reactivate the needed outputs again.
In case of short circuit or overload all the 24 outputs will be switched off.
- (5) Only on output modules.
- (6) Bit 6 of Byte 3 states if the generated emergency message (and its content) refers to the input or the output module.



Note 1: The system generates an emergency message in case one or more input modules are in error.

Note 2: The system generates an emergency message in case one or more output modules are in error.

Note 3: The system generates two emergency messages in case one or more input and output modules are in error.

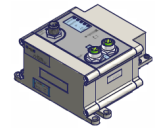

Configuration Parameters - IO-Link

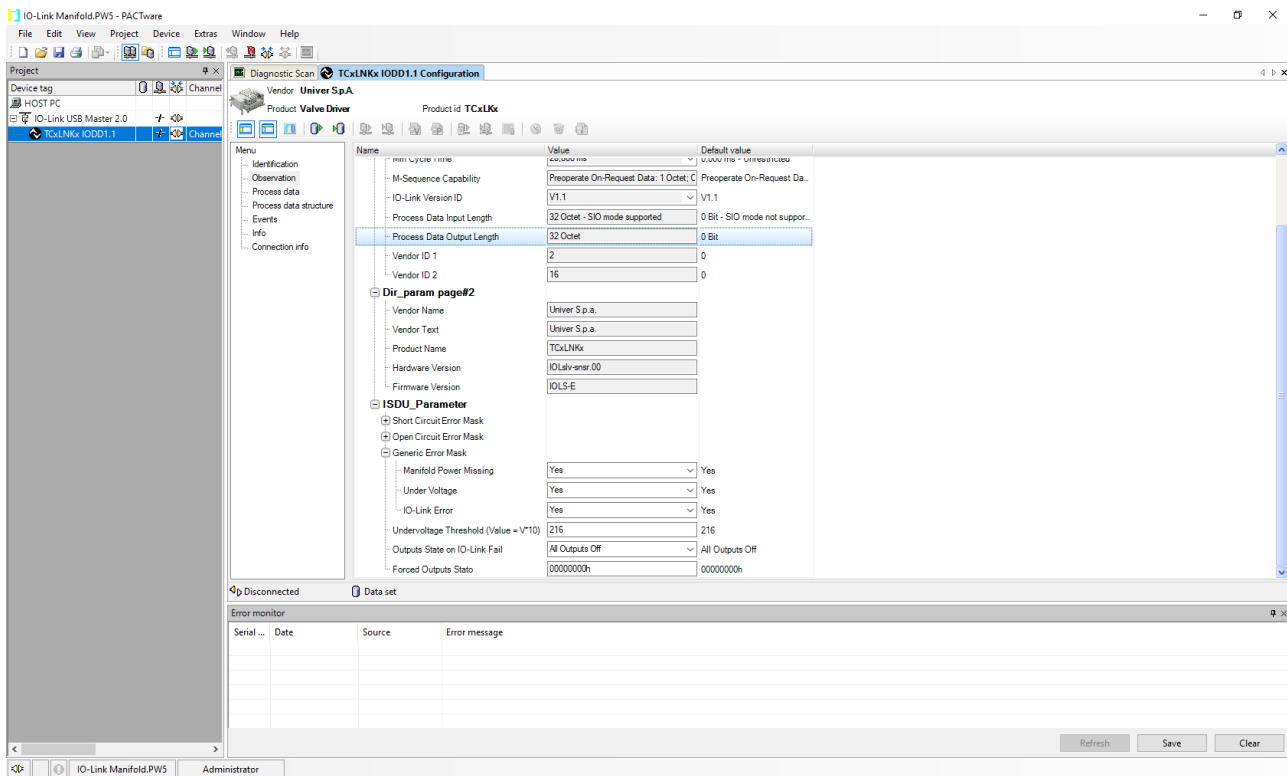

Parameters table

Error Window - Short Circuit	By opening this drop down menu it is possible to activate or deactivate the warning of short circuit for each single output.
Error Window - Open coil	By opening this drop down menu it is possible to activate or deactivate the warning of open circuit for each single output. (1)
Generic error window	No Valve Voltage: if enabled, an error will be generated every time the power supply to the valve is removed or disconnected. Under Voltage Valves: if abled, an error will be generated every time the power supply voltage of the valves drops below the value set by the Voltage Threshold. (2)
Voltage threshold	Threshold below which and Under Voltage error is generated. Normally set to the minimum operating value of the valves.
Output status with IO-Link error	All off: in case of error all the outputs are switched off. Last Status: nothing is done and the last status is set Force Value: the outputs are activated as explained in the below parameter.
Forced output value	Output status to be set in case of IO-Link lack of communication and if Force Value is set as option for Output status in case of IO-Link error.

Note: if not configured by the manufacturer, the Short Circuit Error Window is active on all outputs, the Open Coil Error Window is completely disabled, the Power Failure and Under Voltage Valve signals are both active, the Voltage Threshold is 21,6V, the output behaviour in case of error is all off (once written they keep the last set value) .

- (1) This option must not be activated when using valves with electronic absorption control circuit.
- (2) The error is automatically removed when the voltage rises by about 0.5V above the set threshold.



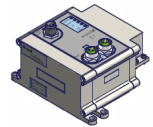

Module assembly system

The auxiliary input and output modules must be connected to the fieldbus module from the side which is opposite to the valve manifold.

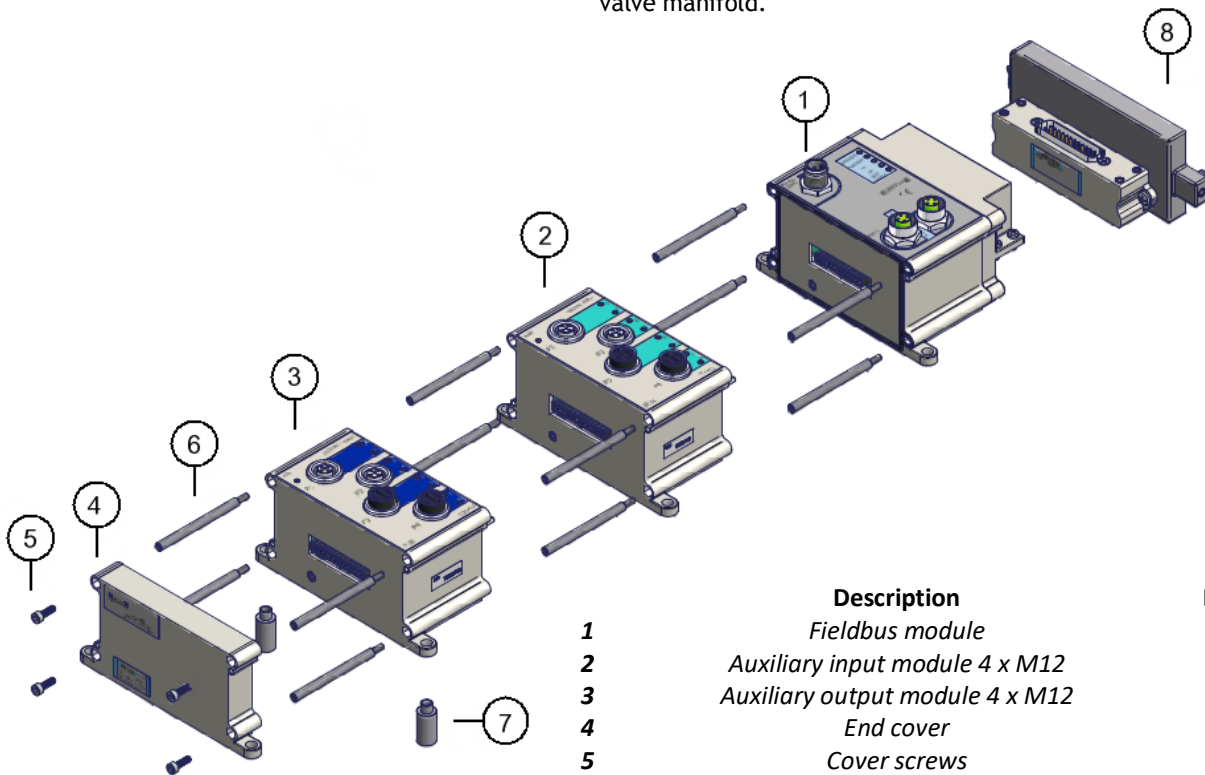

	Description	Part Number
1	Fieldbus module	TCxPN
2	Auxiliary input module 4 x M12	TC8I412
3	Auxiliary output module 4 x M12	TC8U412
4	End cover	PR2895-
5	Cover screws	Included
6	Tie-rods	Included
7	Supports	Included
8	Valve manifold adapter	BDF-x130TIM BDF-x140TIM



Make sure that the module order is always as per the following sequence:

Serial communicator (TCxxx o Texxx).

TCXUS78 if present

Input modules (TC16I812, TC8I412, TC8I808) if present

Output modules (TC8U412, TCR32UD - it must be the last one - if present.

TC-ECSM if present.

TC-2ECD if present.

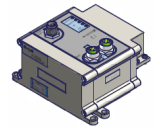

Possible configuration examples

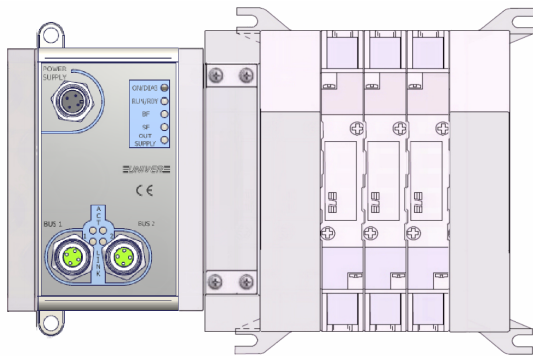

TCxPN device with integrated compact manifold

TCxPN device with integrated compact manifold, M12 output modules and expansions to connect distributed valve manifolds

↓

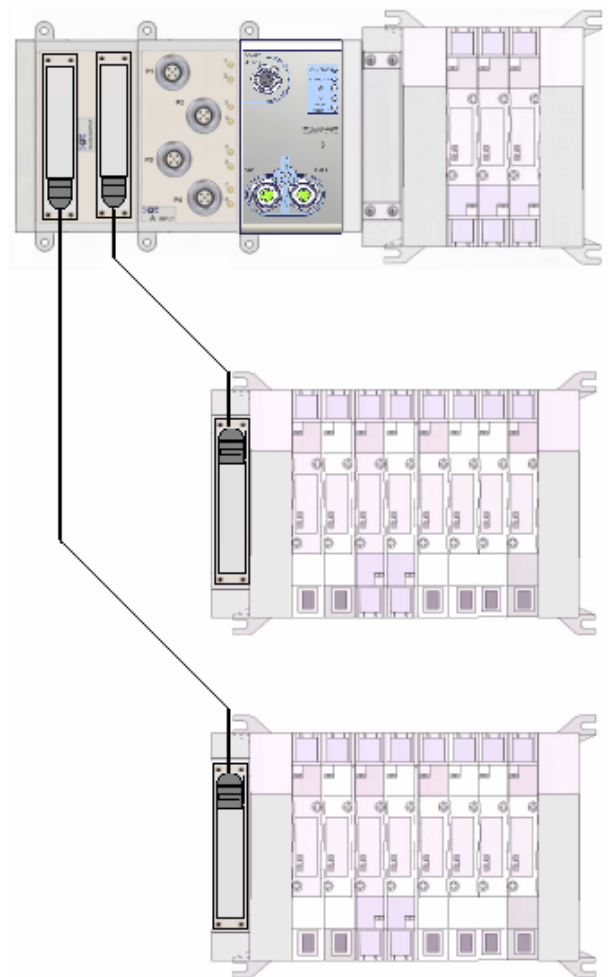

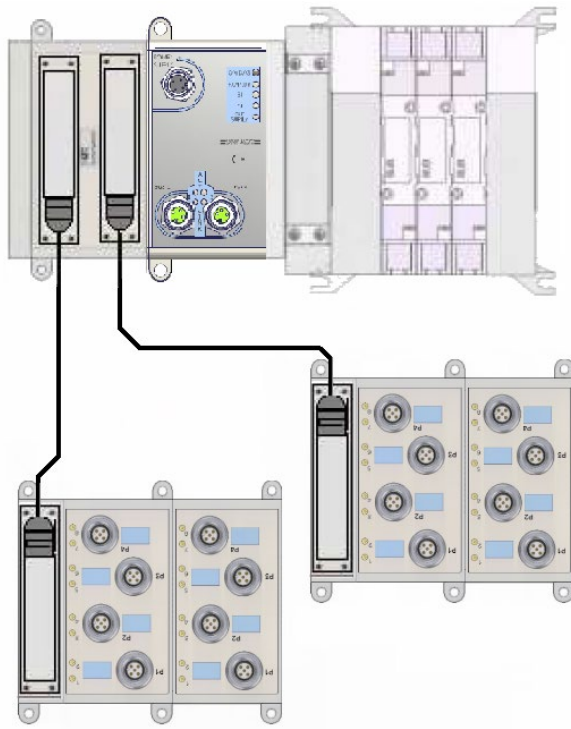
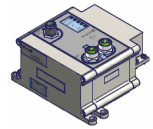

TCxPN device with integrated compact manifold and expansion module to connect distributed valve manifolds.

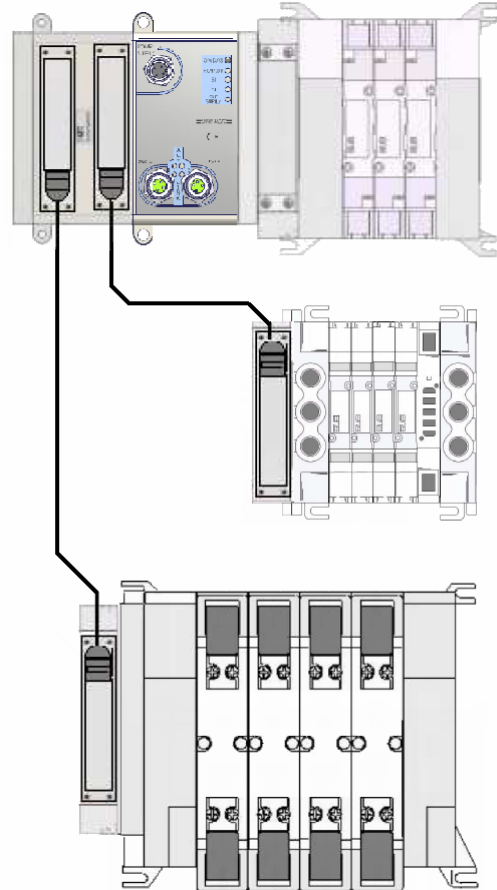

TCxPN device with integrated compact manifold and expansion module for connection to remote passive modules

TExPN device with expansion module for connection to remote passive modules

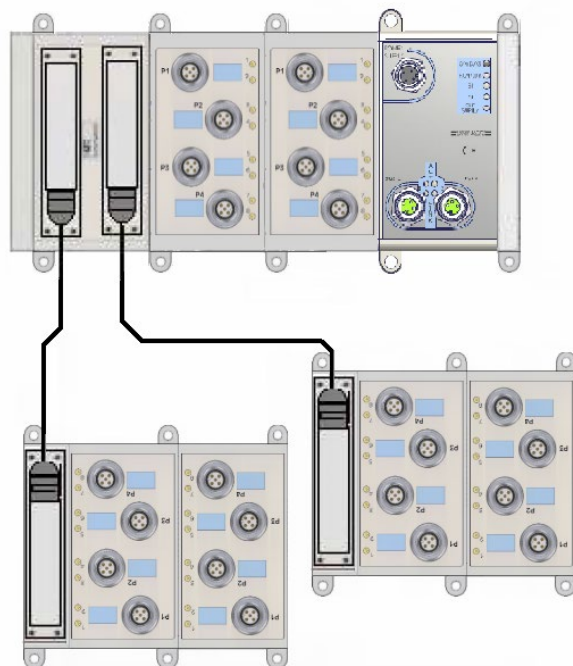

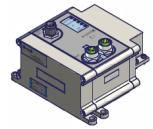

Damages caused by improper use



The use of original spare parts is recommended. Any modification or alteration of the product made arbitrarily by the user is to be considered as an abuse of the conditions, so any warranty will be void. Follow the manufacturer's instructions and analyze any risks that the use of the component may cause within the system where it is installed and provide for proper actions to ensure the safety of the operator.

Correct and incorrect use



The Slave Fieldbus control unit, in all its models, can only be used as indicated by the manufacturer in the operating manual. The safety and reliability requirements of the machine are guaranteed only by using original components and if installed following the appropriate instructions.

Scheduled maintenance frequency

The unit was designed and built so as not to require specific scheduled maintenance.

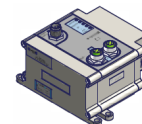

Copyrights



Profinet® and Profibus® are registered trademark and copyright of PNO



EtherNet/IP® is registered trademark and copyright of Open DeviceNet Vendor Association, Inc. (ODVA)



EtherCAT® is registered trademark and patented technology, licensed by Beckhoff Automation GmbH, Germany.



CANopen® is registered trademarks and copyright of CIA.



IO-Link® are registered trademark and copyright of PROFIBUS Nutzerorganisation e.V.