

LCQ63 __ _ U12R

4 STROKE

4

025 = 25 mm
050 = 50 mm

Rod's inner Ø12	
Cylinder	Weight
Ø 63	3,6 Kg

Min./Max. operating pressure: **0,4 / 0,6 MPa**
 Operating temperature: **5° ÷ 45° C**
 Electronic sensor with M12 swivel connector
 Supply voltage: **10 ÷ 30 Vdc**
 IP code: **IP 65**
 Pneumatic ports on both sides

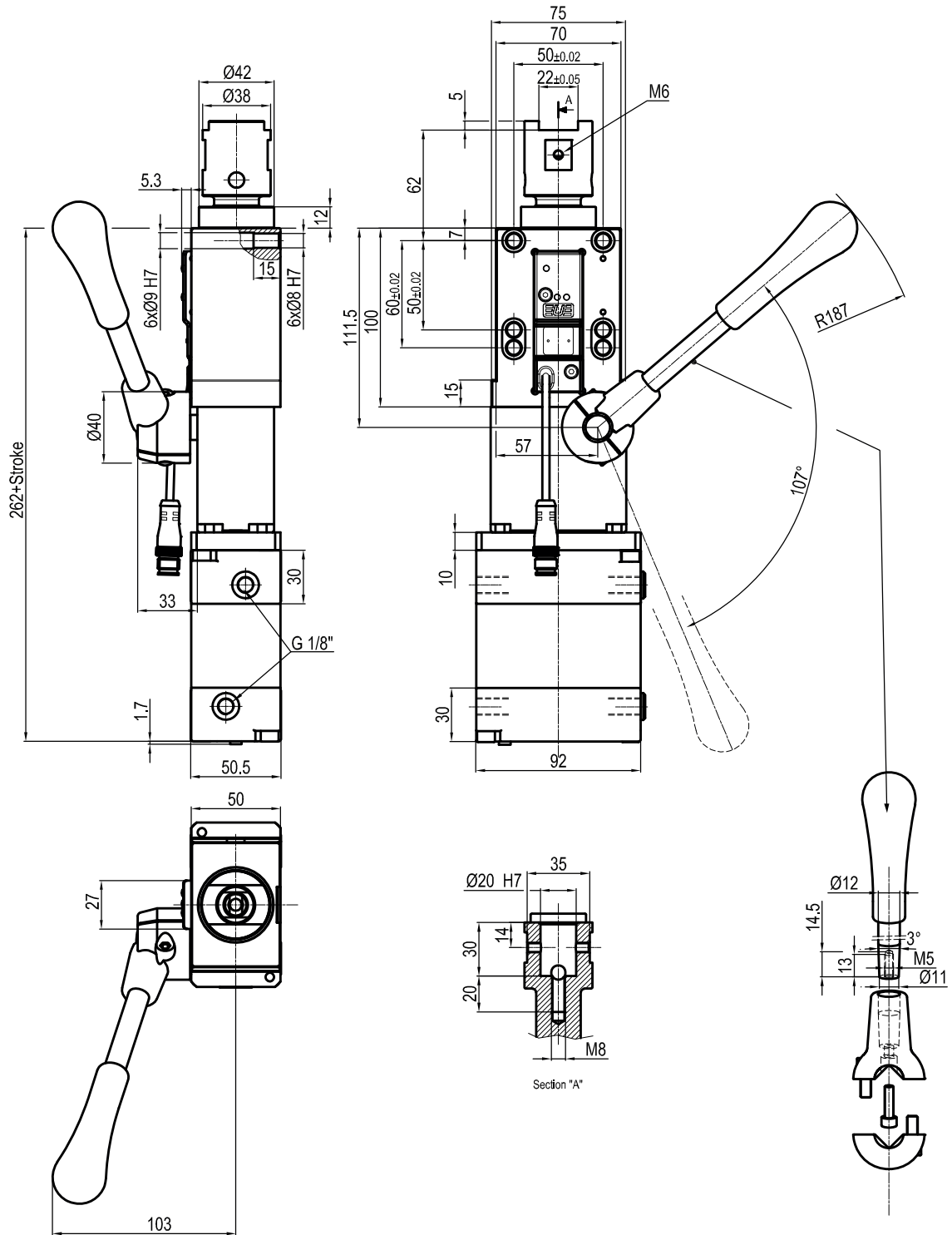

LCQ63 __ _ U20R

4 STROKE

4

025 = 25 mm
050 = 50 mm

Rod's inner Ø20	
Cylinder	Weight
Ø 63	3,6 Kg

Min./Max. operating pressure: **0,4 / 0,6 MPa**
 Operating temperature: **5° ÷ 45° C**
 Electronic sensor with M12 swivel connector
 Supply voltage: **10 ÷ 30 Vdc**
 IP code: **IP 65**
 Pneumatic ports on both sides