

GR8

Modular Tooling System

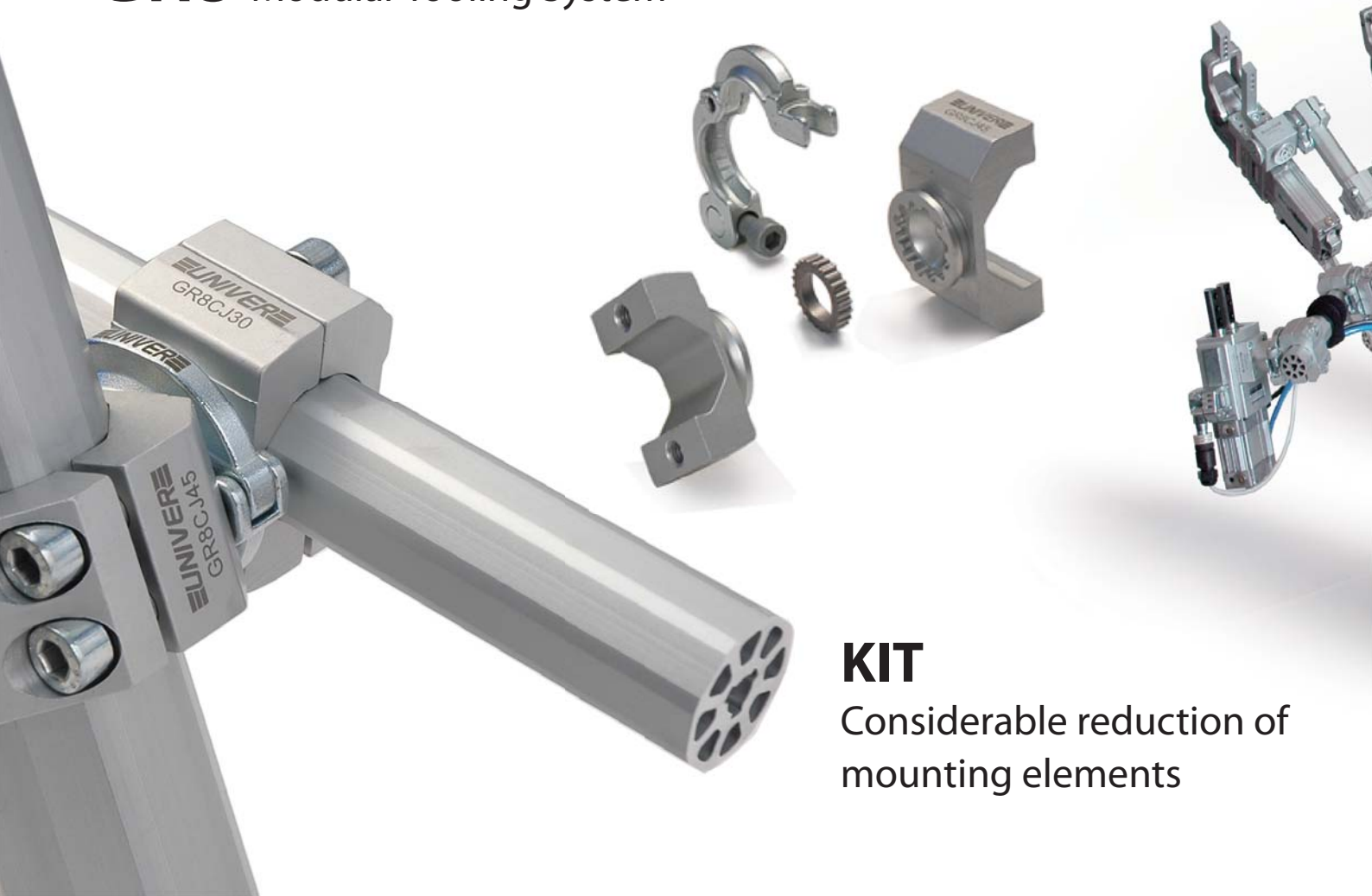

GR8 Modular Tooling System



KIT

Considerable reduction of mounting elements

Ø 30 - 45 - 70 mm booms

Maximum stiffness and minimum weight

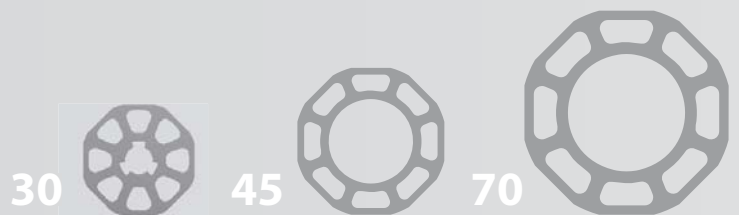

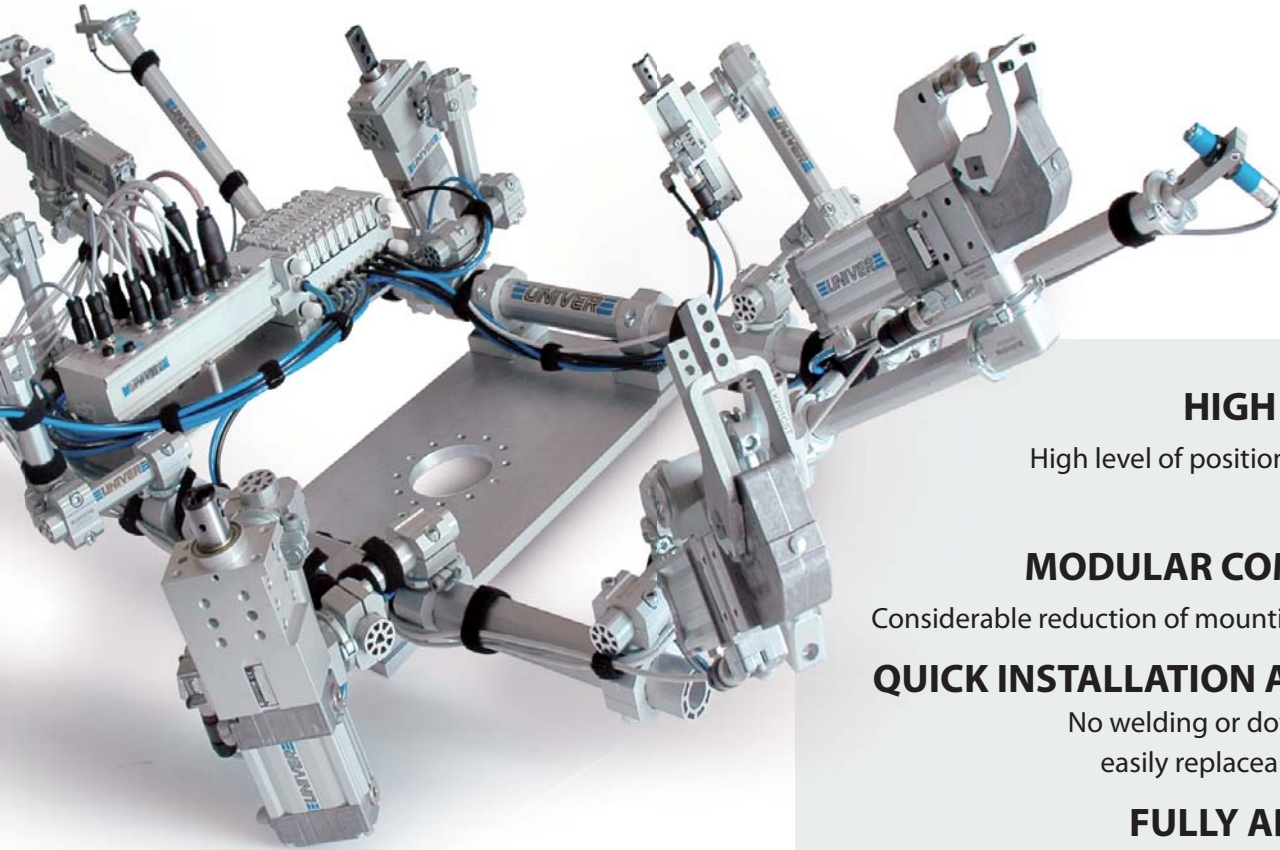

HIGH PRECISION

High level of positional repeatability;
low deflection

MODULAR COMPONENTS

Considerable reduction of mounting components

QUICK INSTALLATION AND SET UP

No welding or doweling required,
easily replaceable components

FULLY ADJUSTABLE

Unlimited orientation in space and free configuration

Locking ring

Precise and efficient system to guarantee a high level of positional accuracy

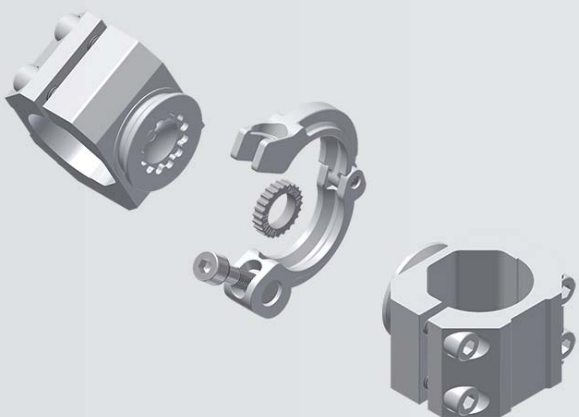





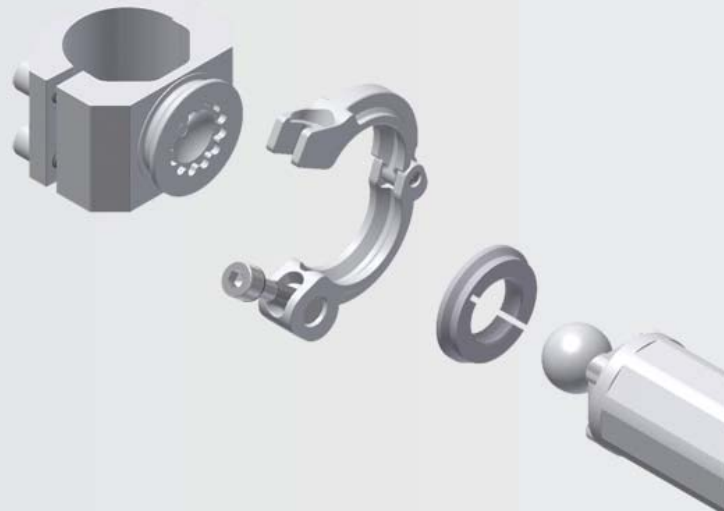









Ball mounting











Unlimited swivel rotation



BOOMS AND BOOM ADAPTERS

<p>■ GR8B30S6000 Octagonal boom Ø30</p> 	<p>■ GR8B456000 Octagonal boom Ø45</p> 	<p>■ GR8B706000 Octagonal boom Ø70</p> 	<p>■ GR8IK Interlocking key insert</p> 	
<p>■ GR8C30 Boom end-cap Ø30</p> 	<p>■ GR8C45 Boom end-cap Ø45</p> 	<p>■ GR8C70 Boom end-cap Ø70</p> 	<p>■ GR8LH Locking ring</p> 	<p>■ GR8LHD Locking ring</p> 
<p>■ GR8SCI30 Interlocking end 30</p>  <p>90 Nm</p>	<p>■ GR8SCI30C Interlocking end 30 for ball mounting</p> 	<p>■ GR8SCI30D Interlocking end 30 D</p>  <p>200 Nm</p>		
<p>■ GR8ECI45 Interlocking end 45</p>  <p>90 Nm</p>	<p>■ GR8ECI45C Interlocking end 45 for ball mounting</p> 	<p>■ GR8ECI45D Interlocking end 45 D</p>  <p>200 Nm</p>		

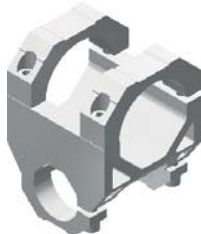

FRAME COMPONENTS

<p>■ GR8BB30 Base plate 30</p> 	<p>■ GR8BB30A Joint 30 without base</p> 	<p>■ GR8BB45 Base plate 45</p> 	<p>■ GR8BB45A Joint 45 without base</p> 	<p>■ GR8BB70 Base plate 70</p> 	<p>■ GR8BB70A Joint 70 without base</p> 
<p>■ GR8HD4530V Joint 45-30</p> 	<p>■ GR8HD4545V Joint 45-45</p> 	<p>■ GR8HD7045 Joint 70-45</p> 	<p>■ GR8HD7070 Joint 70-70</p> 		















FRAME COMPONENTS

<p>■ GR8CM4530 Coplanar Mount 45-30</p> 	<p>■ GR8CM4545 Coplanar Mount 45-45</p> 	<p>■ GR8CM7045 Coplanar Mount 70-45</p> 	<p>■ GR8CM7070 Coplanar Mount 70-70</p> 
<p>■ GR8BL45 Base linear plate 45</p> 	<p>■ GR8BL70 Base linear plate 70</p> 	<p>■ GR8BB4530B Base plate</p> 	

JOINTS

<p>■ GR8BC30 30 mm base connector</p> 	<p>■ GR8BC45 45 mm base connector</p> 	<p>■ GR8BC70 70 mm base connector</p> 
<p>■ GR8CJ30 Cross Joint 30</p> <p>90 Nm</p> 	<p>■ GR8CJ30C Cross Joint 30 for ball mounting</p> 	<p>■ GR8CJ30D Cross Joint 30 D</p> <p>200 Nm</p> 
<p>■ GR8CJ45 Cross Joint 45</p> <p>90 Nm</p> 	<p>■ GR8CJ45C Cross Joint 45 for ball mounting</p> 	<p>■ GR8CJ45D Cross Joint 45 D</p> <p>200 Nm</p> 
<p>■ GR8CJ70 Cross Joint 70</p> <p>90 Nm</p> 	<p>■ GR8CJ70C Cross Joint 70 for ball mounting</p> 	<p>■ GR8CJ70D Cross Joint 70 D</p> <p>200 Nm</p> 

JOINTS

<p>■ GR8CJD30 Double cross joint 30</p> <p>90 Nm</p> 	<p>■ GR8CJD30C Double cross joint 30 for ball mounting</p> 	<p>■ GR8CJD30D Double cross joint 30 D</p> <p>200 Nm</p> 
<p>■ GR8CJD45 Double cross joint 45</p> <p>90 Nm</p> 	<p>■ GR8CJD45C Double cross joint 45 for ball mounting</p> 	<p>■ GR8CJD45D Double cross joint 45 D</p> <p>200 Nm</p> 
<p>■ GR8RJ30 Round Joint 30</p> <p>90 Nm</p> 	<p>■ GR8RJ30C Round Joint 30 for ball mounting</p> 	<p>■ GR8RJ30D Round Joint 30 D</p> <p>200 Nm</p> 
<p>■ GR8RJ45 Round Joint 45</p> <p>90 Nm</p> 	<p>■ GR8RJ45C Round Joint 45 for ball mounting</p> 	<p>■ GR8RJ45D Round Joint 45 D</p> <p>200 Nm</p> 
<p>■ GR8RJ70 Round Joint 70</p> <p>90 Nm</p> 	<p>■ GR8RJ70C Round Joint 70 for ball mounting</p> 	<p>■ GR8RJ70D Round Joint 70 D</p> <p>200 Nm</p> 

JOINTS

■ **GR8R3025**
Adapter octagon 30
to round 25



■ **GR8R4540**
Adapter octagon 45
to round 40



ANGLE ADAPTERS

■ **GR8EOA45**
Orientable angle 45°

90 Nm



■ **GR8EOA45C**
Orientable angle 45°
for ball mounting



■ **GR8EOAD45**
Orientable angle 45° D

200 Nm



■ **GR8EOA**
Orientable angle 90°

90 Nm



■ **GR8EOAC**
Orientable angle 90°
for ball mounting



■ **GR8EOAD**
Orientable angle 90° D

200 Nm



■ **GR8A30**
Edge mount orientable
side for 30 mm boom

90 Nm



■ **GR8A30D**
Edge mount orientable
side for 30 mm boom D

200 Nm



■ **GR8A3045**
45° mounting element
for 30 mm boom

90 Nm



■ **GR8A3045D**
45° mounting element
for 30 mm boom D

200 Nm



■ **GR8A45**
Edge mount orientable
side for 45 mm boom

90 Nm



■ **GR8A45D**
Edge mount orientable
side for 45 mm boom D

200 Nm



■ **GR8SM3030**
Edge mounting 30-30



■ **GR8SM3045**
Edge mounting 30-45



■ **GR8SM4545**
Edge mounting 45-45



90 Nm









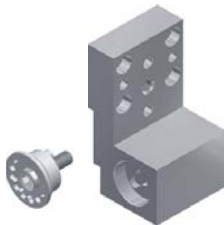

200 Nm

Max static load

BALL ADAPTERS

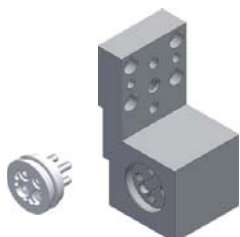
<p>■ GR8MP12 Proximity mount 12 mm</p> 	<p>■ GR8MP18 Proximity mount 18 mm</p> 	<p>■ GR8MP30 Proximity mount 30 mm</p> 
<p>■ GR8MP19 Vacuum cup adapter</p> 	<p>■ GR8SCB30 Ball mount 30</p> 	<p>■ GR8SCB45 Ball mount 45</p> 

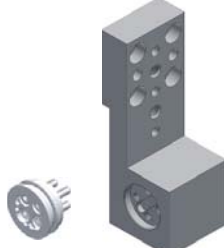
FRONT MOUNT PLATES

<p>■ GR8MF40A Front mount plate for clamps size 40</p> 	<p>■ GR8RMF40A Interlocking adapter for GR8MF40A and GR8MFGL</p> 	<p>■ GR8MF40P Mount plate for GR8MF40A and GR8MFGL</p> 	<p>■ GR8RMF40C Mount flange angle for GR8MF40A and GR8MF40D</p> 
<p>■ GR8MF40D Front mount plate D for clamps size 40</p> 	<p>■ GR8RMF4050AD Interlocking adapter for GR8MF40D, GR8MF50D, GR8MFGLD</p> 	<p>■ GR8MF40PD Mount plate for GR8MF40D and GR8MFGL</p> 	
<p>■ GR8MF50D Front mount plate D for clamps size 50/63</p> 	<p>■ GR8MF50PD Mount plate for GR8MF50D</p> 	<p>■ GR8RMF50C Mount flange angle for GR8MF50D</p> 	

FRONT MOUNT PLATE

■ **GR8MFGL**
Front mount plate
for UGP40VL



■ **GR8MFGLD**
Front mount plate D
for UGP40VL



■ **GR8MFGLC**
Counter mount
for GR8MFGL and GR8MFGLD



REAR MOUNT PLATE

■ **GR8SR40**
Rear mount plate
for clamps size 40



■ **GR8SR40D**
Rear mount plate D
for clamps size 40

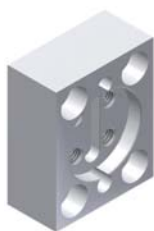

■ **GR8SR50**
Rear mount plate
for LCP50

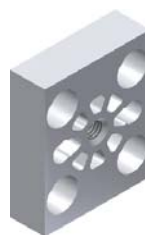

■ **GR8SR50D**
Rear mount plate D
for LCP50



■ **GR8SR50M8**
Rear mount plate
with M8 threads
for clamps size 50/63



■ **GR8SR50M8D**
Rear mount plate D
with M8 threads
for clamps size 50/63



■ **GR8SB4530**
Rear mount plate



■ **GR8SB4530M8**
Rear mount plate
with M8 threads

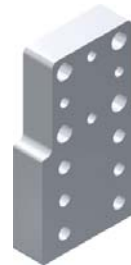

■ **GR8SSLC**
Flange mount for LCP

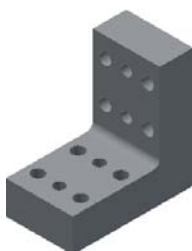

■ **GR8SSLCM8**
Flange mount for LCP
with M8 threads

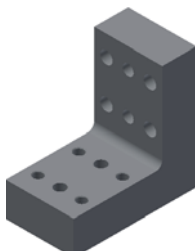

LGP ADAPTERS

■ **LGP32MO25**
Orbital mount 360°, ball Ø25 mm
for LGPS32



■ **LGP32MO30**
Orbital mount 360°, ball Ø30 mm
for LGPS32



■ **LGP32MP**
Middle flange mount
for LGPS32



■ **LGP40MP**
Middle flange mount
for LGPS40



■ **LGP40MO25**
Orbital mount 360°, ball Ø 25mm
for LGPS40



■ **LGP40MO30**
Orbital mount 360°, ball Ø30 mm
for LGPS40



■ **LGP40MO40**
Orbital mount 360°, ball Ø40 mm
for LGPS40



■ **LGP40MO45**
Orbital mount 360°, ball Ø45 mm
for LGPS40



■ **LGP32PT070**
Rear flange mount 70 mm
for LGPS32

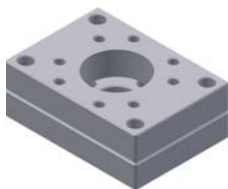

■ **LGP40PT080**
Rear flange mount 80 mm
for LGPS40

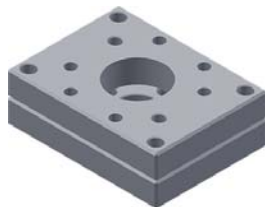

■ **LGP40PT110**
Rear flange mount 110 mm
for LGPS40

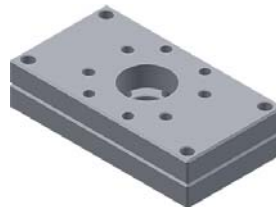

RISERS

■ **GR8SK30**
Riser size 30



■ **GR8SK45**
Riser size 45



■ **GR8SK70**
Riser size 70



GR8

GR8 applications and details of the components

COMPLETE SOLUTION
WITH **UNIVER** COMPONENTS

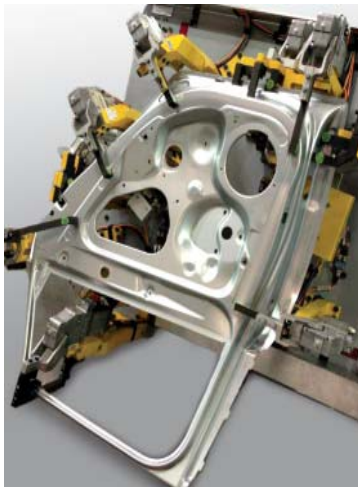

Unlimited and complex configurations
Weight-optimized standard components and brackets
Quick installation and adjustment

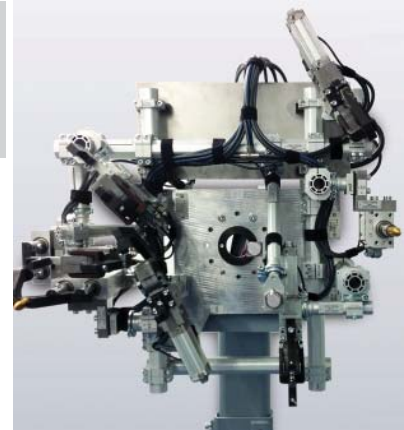



UNIVER S.p.A.

Headquarters

I - 20128 **Milano**
Via Eraclito, 31
Tel. +39 02 25298.1
Fax +39 02 2575254
info@univer-group.com
www.univer-group.com

UNIVER SERVICE S.r.l.

Headquarters

I - 20128 **Milano**
Via Empedocle, 20
Tel. +39 02 25298.1
Fax +39 02 25298370
universervice@universervice.it
www.universervice.it

Branch Offices

LOMBARDIA

I - 20128 **Milano**
Via Empedocle, 20
Tel. +39 02 25298.1
Fax +39 02 25298370
universervice@universervice.it

I - 24060 Castelli Calepio **Bergamo**
Via C. Curotti, 31/33
Tel. +39 030 7435420
Fax +39 030 733328
castellicalepio@universervice.it

I - 22040 Monguzzo **Como**
Via Valassina, 18/b3
Tel. +39 031 617922
Fax +39 031 651222
monguzzo@universervice.it

PIEMONTE/LIGURIA/VALLE D'AOSTA

I - 10071 Borgaro Torinese **Torino**
Via Veneto, 18
Tel. +39 011 4501871
Fax +39 011 4502898
torino@universervice.it

VENETO/FRIULI VENEZIA-GIULIA TRENTINO-ALTO ADIGE

I - 30030 Vigonovo **Venezia**
Via Prima strada 16/A - Loc. Galta
Tel. +39 049 9834140
Fax +39 049 9833972
vigonovo@universervice.it

EMILIA ROMAGNA

I - 40069 Zola Predosa **Bologna**
Via Balzani, 5
Tel. +39 051 753907
Fax +39 051 6184751
bologna@universervice.it

CENTRO/SUD

I - 40069 Zola Predosa **Bologna**
Via Balzani, 5
Tel. +39 051 753907
Fax +39 051 6184751
bologna@universervice.it

UNIVER DO BRASIL S/A

BRAZIL - 13474-764
Americana **São Paulo**
Rua do Polyester, 29
Distrito Industrial Abdo Najar
Tel. +55 19 3113-9400
Fax +55 19 3113-9405
atendimento@univer.com.br

UNIVER CHINA

CHINA - Shanghai
399 Fu Te North Road,
Free Zone, Pudong
info@univer-china.com

UNIVER FRANCE S.a.s.

FRANCE - 68000
Colmar
1, rue Denis Papin
Tel. +33 3 89210900
Fax +33 3 89216850
info@univer-france.fr

UNIVER G.m.b.H.

GERMANY - D-65428
Rüsselsheim
Eisenstraße 51
Tel. +49 6142 408320
Fax +49 6142 4083290
info@univer-gmbh.de

UNIVER NORTH AMERICA

USA - 48312
Sterling Heights - **Michigan**
6620 Cobb Drive
Tel. +1 248 299 0525
Fax +1 248 299 0528
info@univer-group.us

UNIVER POLSKA Sp. z o.o.

POLAND - 25-663
Kielce
ul. K. Olszewskiego 21E
Tel. +48 41 278 72 53
Fax +48 41 278 72 54
univer@univer-group.pl

UNIVER S.L.

SPAIN - 08210
Barbera Del Valles **Barcelona**
Ronda Industria, 26 - 28
Tel. +34 93 7297360
Fax +34 93 7297380
univer@univerweb.com

Distributors worldwide:

Get in touch with UNIVER Sales Department
or visit our website www.univer-group.com



www.univer-group.com