

RO-RN

Ø16 ÷ 63 mm UNITOP, ISO 21287 Compact Cylinders

- Extended piston rod version available
- Equipped with adjustable pneumatic cushioning for a sensible reduction of noise
- Magnetic version standard supplied
- Non-rotating octagonal tube

Available ATEX version upon request



TECHNICAL CHARACTERISTICS

Ambient temperature	-20 ÷ 80°C
Fluid	filtered air, with or without lubrication
Working pressure	1,5 ÷ 10 bar
Bores	Ø 016 - 020 - 025 - 032 - 040 - 050 - 063 mm
Cushionings	adjustable on both sides (UNIVER Original standard supplied)

CONSTRUCTIVE CHARACTERISTICS

End-caps	die-cast zamak (Ø 16 ÷ 25 mm), aluminium (Ø 32 ÷ 63 mm)
Barrel	anodized aluminium
Piston	aluminium
Guide slide	acetalic resin
Piston rod	chromium-plated, rolled stainless steel AISI 303 upon request
Piston seal	nitrile rubber (NBR)
Guide bush for piston rod	acetalic resin
Shock absorber seals	nitrile rubber (NBR) on both sides
Magnet	plasto-ferrite (standard supplied)

CODIFICATION KEY

R	O	2	0	0	0	3	2	0	0	2	5		
1	2	3	4				5			6	7		

1 Series	2 Type	3 Version	
RO = Ø16 ÷ 63 mm - UNITOP Compact Cylinders octagonal tube - NON-ROTATING RN = Ø32 ÷ 63 mm - ISO 21287 Compact Cylinders octagonal tube - NON-ROTATING 	RO 1 = Stainless steel female piston rod with flange 2 = Chromium-plated steel female piston rod with flange RN 3 = Stainless steel male piston rod 4 = Chromium-plated steel male piston rod	Type 1 - 2 00 = D.A. Standard version 01 = D.A. Through piston rod 20 = D.A. Long piston (Ø32 ÷ 63 mm) D.A. = Double acting	Type 3 - 4 00 = D.A. Standard version 01 = D.A. Through piston rod 20 = D.A. Long piston (Ø32 ÷ 63 mm)
4 Bore (mm)	5 Stroke (mm)	6 Option	7 Atex option
016 = Ø16 020 = Ø20 025 = Ø25 032 = Ø32 040 = Ø40 050 = Ø50 063 = Ø63	0005 - 0010 - 0015 - 0020 - 0025 - 0030 - 0040 0050 - 0060 - 0080 Max standard stroke 0040 (Ø16) 0050 (Ø20-25) 0080 (Ø32÷63)	H = Hollow piston rod only for through piston rod versions without flange	X = Atex (upon request) See ATEX Catalogue for types and versions

Stroke tolerances

Ø	mm
16	+1,5 - 0
20	+1,5 - 0
25	+1,5 - 0
32	+2 - 0
40	+2 - 0
50	+2 - 0
63	+2,5 - 0

Maximum torque (Nm)

Ø	Nm
16	0,5
20	0,8
25	1
32	2
40	3
50	5
63	8

Theoretical forces (N)

at different working pressure (bar)

Ø	Surface area		Working pressure				Working pressure					
	mm ²		bar				bar					
	Thrust	Traction	Thrust				Traction					
			2	4	6	8	10	2	4	6	8	10
16	201	151	40	80	121	161	201	30	60	91	121	151
20	314	236	63	126	188	251	314	47	94	142	189	236
25	491	412	98	196	295	393	491	82	165	247	330	412
32	804	691	161	322	482	643	804	138	276	414	553	691
40	1256	1143	251	502	754	1005	1256	228	457	685	914	1143
50	1962	1762	393	785	1178	1570	1963	352	704	1057	1409	1762
63	3116	2916	623	1246	1869	2493	3116	583	1166	1749	2332	2916

In case of pneumatic cylinders with through piston rod, the theoretical force to be considered, in both directions, is always equal to the "traction" value indicated in the table. For practical purposes these values should be reduced taking into account the weight and sliding friction of the moving element (~ -10%).

1

Mass - Standard and long piston version

Ø	Cylinder stroke 0 Standard	Cylinder stroke 0 Long piston	Increase per mm stroke	Moving element stroke 0 Standard	Moving element stroke 0 Long piston	Increase per mm stroke
	g	g	g	g	g	g
	RO200	RO220	RO200/220	RO200	RO220	RO200/220
16	110	-	1,05	22,5	-	0,39
20	150	-	1,45	38,5	-	0,62
25	225	-	1,65	54,5	-	0,62
32	229	316,5	2,65	84	136,5	0,9
40	344	466	3,3	113,5	188	0,9
50	517	746,5	4,7	192	344	1,6
63	829	1161,5	5,65	294	525	1,6

Mass - Through piston rod cylinder

Ø	Cylinder stroke 0 Standard	Increase per mm stroke	Moving element stroke 0 Standard	Increase per mm stroke
	g	g	g	g
	RO201	RO201	RO201	RO201
16	112	1,45	24,5	0,78
20	153	2,07	39	1,24
25	228	2,27	55	1,24
32	254	3,55	109	1,8
40	364	4,2	138,5	1,8
50	557	6,3	232	3,2
63	869	7,25	339	3,2

Peak load

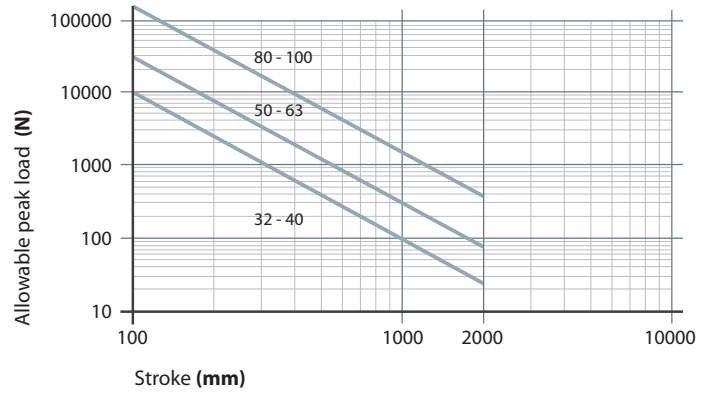
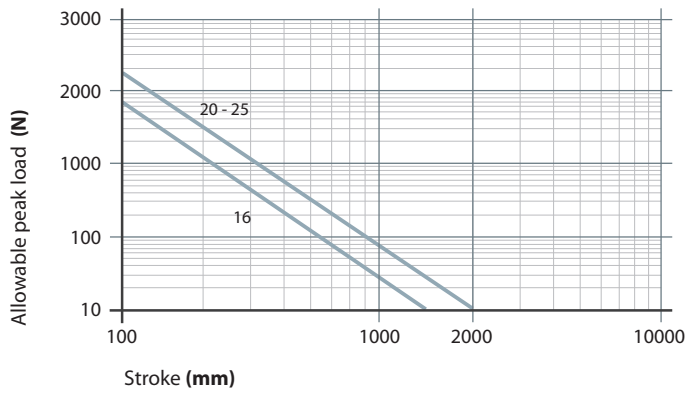

Graph side load on piston rod

Standard piston Ø16 ÷ 25 mm

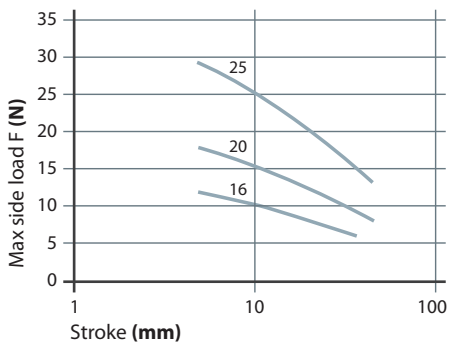

Standard piston Ø32 ÷ 63 mm

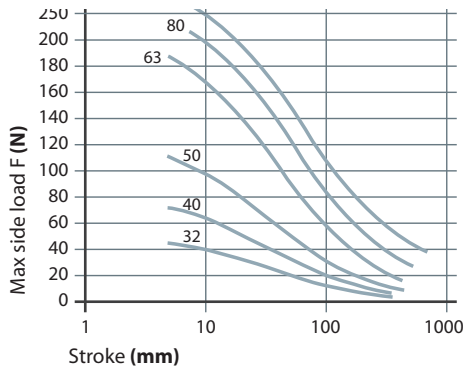

Long piston Ø32 ÷ 63 mm

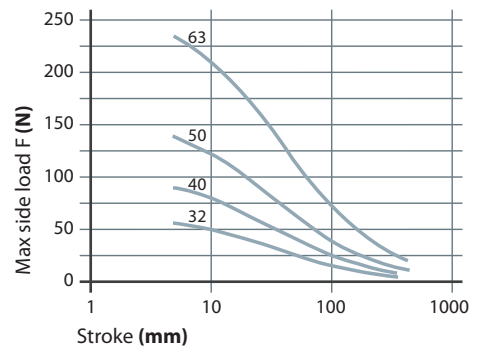

RO fixing elements and accessories

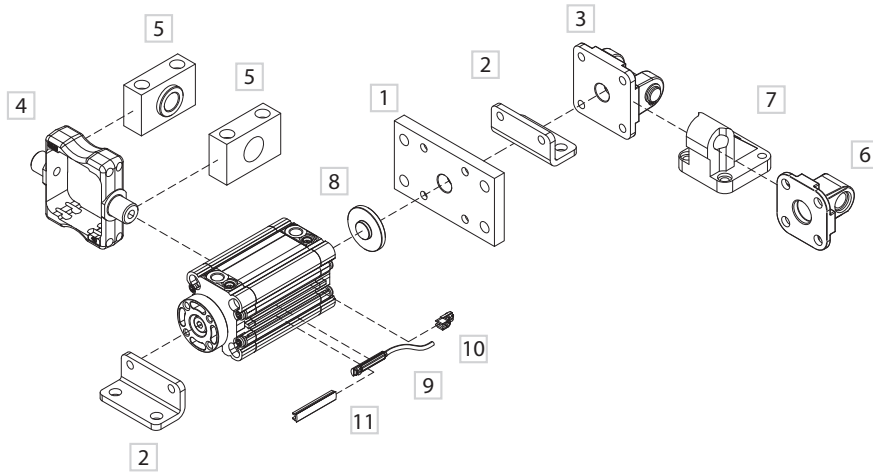

1

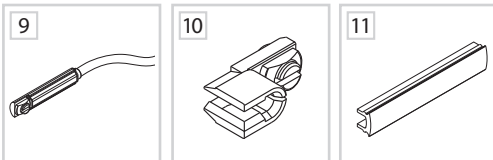

DESCRIPTION	PART NO.
1 Front/rear flange	RPF-12___ / KF-12___ (Ø32)
2 Angle bracket	RPF-13___ / KF-13___ (Ø32)
3 Rear female hinge with pin	RPF-10___ A / KF-10___ A (Ø32)
4 Intermediate hinge	RPF-14___ / KDF-14___ (Ø32)
5 Hinge support	KF-41___
6 Rear male hinge	RPF-11___ / KF 11___ (Ø32)
7 Counter hinge 90°	KF-19___ Ø32 ÷ 63
8 Centering adaptor ring	RSF-09___ Ø32 ÷ 63
9 DF sensor (see accessories section)	DF-___
10 Cable clamping for DF sensor (see accessories section)	DF-001
11 DHF covering strip (see accessories section)	DHF-0020100

RN fixing elements and accessories

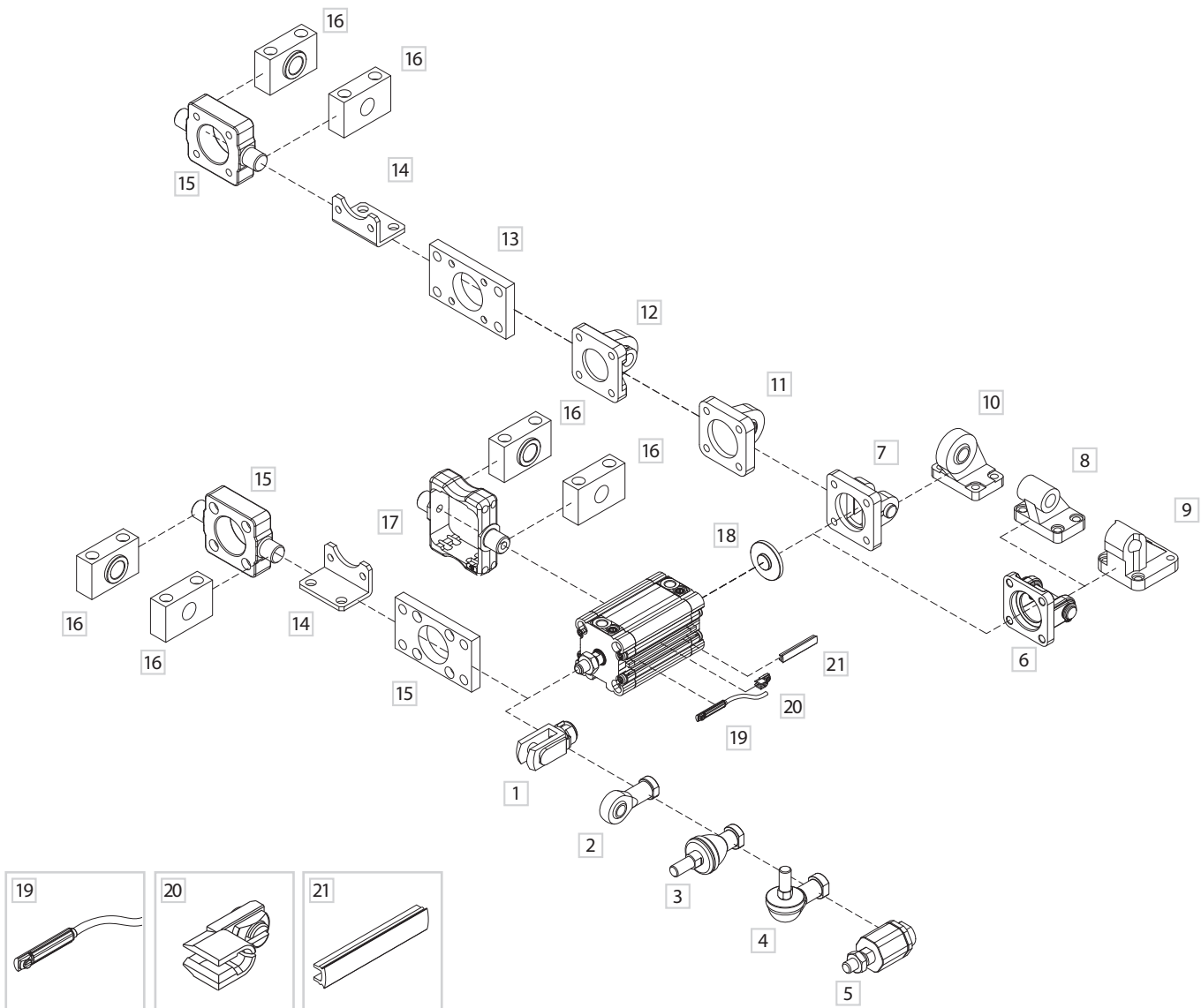

DESCRIPTION	PART NO.
1 Female fork with clips	KF-15___ / MF-15___ (Ø16-20-25)
2 Articulated self-lubricating fork	KF-17___ / MF-17___ (Ø16-20-25)
3 Fork with axially mounted articulated pin	KF-22___ / MF-22___ (Ø16-20-25)
4 Fork with angle mounted articulated pin	KF-23___ / MF-23___ (Ø16-20-25)
5 Floating joint	KF-24___ / MF-24___ (Ø16-20-25)
6 Female rear hinge with pin	KF-10___A
7 Narrow female hinge with pin	KF-10___AS
8 Counter hinge 90° (CETOP)	KF-19___CTA
9 Counter hinge 90°	KF-19___
10 Articulated counter hinge	KF-19___SC
11 Articulated rear male hinge	KF-11___S
12 Rear male hinge	KF-11___ RPF (Ø16-20-25)
13 Front/rear flange	KF-12___ RPF (Ø16-20-25)
14 Angle bracket	KF-13___ RPF (Ø16-20-25)
15 Front/rear hinge with floating pin	KF-14___AP
16 Hinge support	KF-41___
17 ISO intermediate hinge	KDF-14___ (Ø32)/ RPF-14___ (Ø40-50-63)
18 Centering adaptor ring	RSF-09___ (Ø32÷100)
19 DF Sensor (see accessories section)	DF-___
20 Cable clamping for DF sensor (see accessories section)	DF-001
21 DHF covering strip (see accessories section)	DHF-0020100

Double-acting non-rotating piston rod Ø 16 ÷ 25

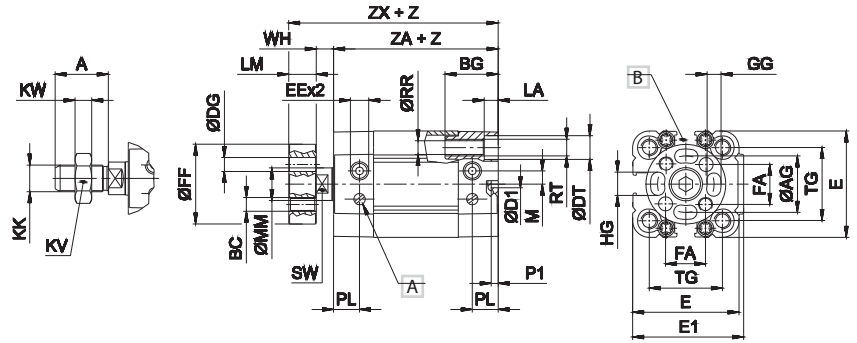
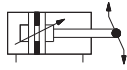

Double-acting non-rotating piston rod Ø 32 ÷ 63

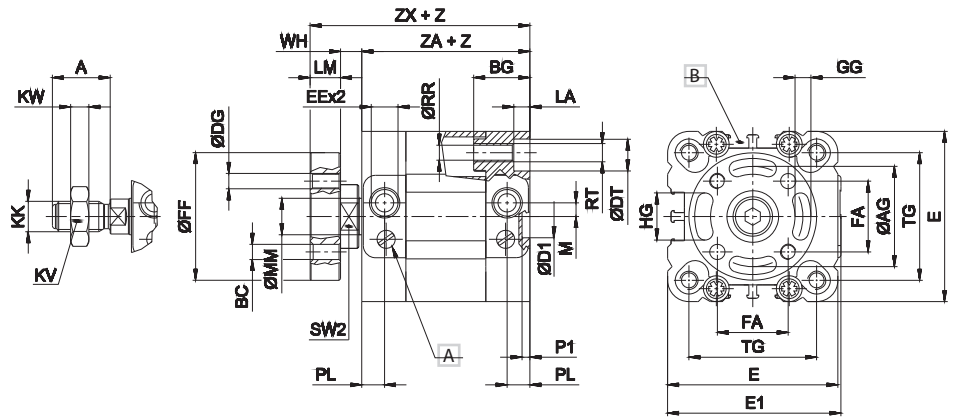
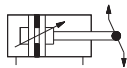
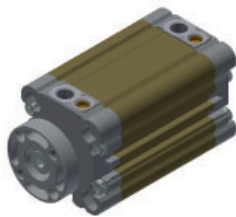

Z = Stroke

Ø	A	AG	BC	BG	DG	DT	D1	E	EE	E1	FA	FF	GG	HG	KK	KV
16	12	14	M3	16	3	5,8	2	28	M5	30	9,9	19	3	5	M6x1	10
20	16	17	M4	16	4	7,3	2	32	M5	34	12	24	4	7	M8x1,25	13
25	16	22	M5	16	5	8	2	37	M5	39	15,6	30	5	9	M8x1,25	13
32	19	28	M5	18	5	9	14	46	G1/8	47	19,8	37	5,2	11	M10x1,25	17
40	19	33	M5	18	5	9	14	56	G1/8	57	23,3	42	5,2	15	M10,x1,25	17
50	22	42	M6	24	6	11	18	66	G1/8	67	29,7	52	6,2	19	M12x1,25	19
63	22	50	M6	24	6	11	18	79	G1/8	80	35,4	64	6,2	25	M12x1,25	19

Ø	KW	LA	LM	LW	M	MM	PL	P1	RR	RT	SW	SW2	TG	WH	ZA	ZX
16	4	3,2	6	4,5	3,5	8	8	2	3,2	M4	7	-	18	5	37	48
20	5	4,2	8	4,5	4	10	8	2	4,2	M5	8	-	22	6	37	51
25	5	4,5	8	4,5	4	10	8	2	4,2	M5	8	-	26	6	39	53
32	6	5,3	10	5	4,5	12	7,5	2,5	5,2	M6	10	17	32,5	7	44	61
40	6	5,3	10	5	4,5	12	7,5	2,5	5,2	M6	10	19	42*	7	45	62
50	7	6,5	12	6	6,5	16	7,5	2,5	6,5	M8	13	24	50*	8	45	65
63	7	6,5	12	6	6,5	16	7,5	2,5	6,5	M8	13	24	62*	8	50	70

A Pneumatic cushioning adjusting screw

B Groove for sensor

* = Dimensional variations for end-caps with ISO inter-axes (RN series): Ø40 38 mm - Ø50 46,5 mm - Ø63 56,5 mm

Long piston RN Ø 32 ÷ 63

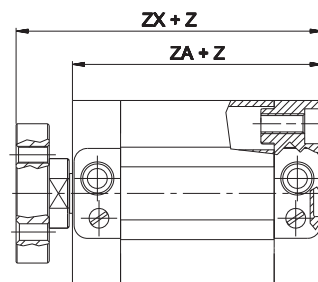

Z = Stroke

Ø	ZA	ZX
32	64	81
40	65	82
50	70	90
63	75	95

For cylinder types with long piston, dimensions ZA and ZX will be increased by 20 mm (Ø32 - Ø40 mm) and by 25 mm (Ø50 - Ø63 mm)

Double-acting non-rotating through piston rod Ø 16 ÷ 25

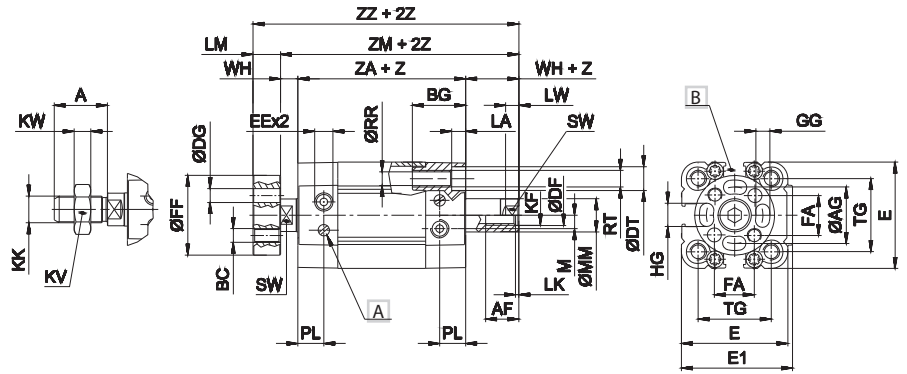
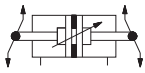
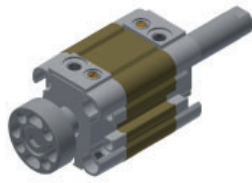

Double-acting non-rotating through piston rod Ø 32 ÷ 63

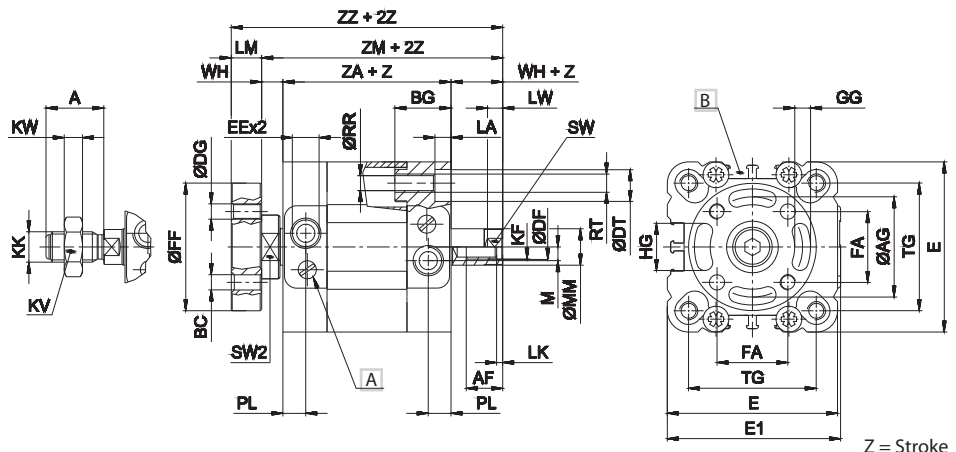
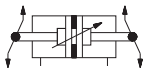
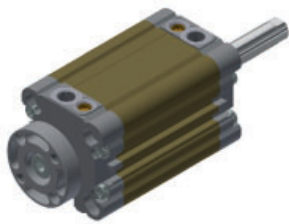

Z = Stroke

Ø	A	AF	AG	BC	BG	DF	DG	DT	E	EE	E1	FA	FF	GG	HG	KF	KK
	16	12	8	14	M3	16	4,1	3	5,8	28	M5	30	9,9	19	3	5	M4
20	16	10	17	M4	16	6,1	4	7,3	32	M5	34	12	24	4	7	M6	M8x1,25
25	16	10	22	M5	16	6,1	5	8	37	M5	39	15,6	30	5	9	M6	M8x1,25
32	19	12	28	M5	18	8,2	5	9	46	G1/8	47	19,8	37	5,2	11	M8	M10x1,25
40	19	12	33	M5	18	8,2	5	9	56	G1/8	57	23,3	42	5,2	15	M8	M10x1,25
50	22	16	42	M6	24	10,2	6	11	66	G1/8	67	29,7	52	6,2	19	M10	M12x1,25
63	22	16	50	M6	24	10,2	6	11	79	G1/8	80	35,4	64	6,2	25	M10	M12x1,25

Ø	KV	KW	LA	LM	LK	LW	M	MM	PL	RR	RT	SW	SW2	TG	WH	ZA	ZM	ZZ
	16	10	4	3,2	6	1	4,5	3,5	8	8	3,2	M4	7	-	18	5	37	47
20	13	5	4,2	8	1	4,5	4	10	8	4,2	M5	8	-	22	6	37	49	57
25	13	5	4,5	8	1	4,5	4	10	8	4,2	M5	8	-	26	6	39	51	59
32	17	6	5,3	10	2	5	4,5	12	7,5	5,2	M6	10	17	32,5	7	44	58	61
40	17	6	5,3	10	2	5	4,5	12	7,5	5,2	M6	10	19	42*	7	45	59	62
50	19	7	6,5	12	2	6	6,5	16	7,5	6,5	M8	13	24	50*	8	45	61	65
63	19	7	6,5	12	2	6	6,5	16	7,5	6,5	M8	13	24	62*	8	50	68	70

A Pneumatic cushioning adjusting screw

B Groove for sensor

* = Dimensional variations for end-caps with ISO inter-axes (RN series): Ø40 38 mm - Ø50 46,5 mm - Ø63 56,5 mm

Male hollow through piston rod Ø 16 ÷ 63

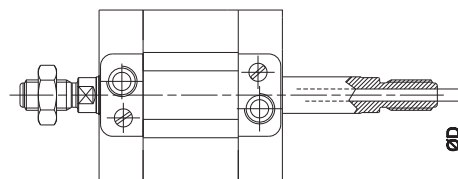
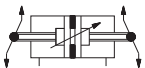

Ø	D
16	2
20	2,5
25	2,5
32	3,5
40	3,5
50	4,5
63	4,5

Ø16 ÷ 25 Max stroke 50 mm Ø32 ÷ 63 Max stroke 75 mm

For all other dimensions please refer to the through piston rod version

Female hollow through piston rod upon request

Tandem version

CODIFICATION KEY

R	O	1	A	0	2	0	0	4	0
1	2	3	4						

1 Series	2 Type	3 Bore (mm)	4 Stroke (mm)
RO = Ø16 ÷ 63 mm - UNITOP Compact Cylinders octagonal tube NON-ROTATING RN = Ø16 ÷ 63 mm - ISO 21287 Compact Cylinders octagonal tube NON-ROTATING Magnetic series	1A = Double thrust tandem, stainless steel female piston rod with flange 2A = Double thrust tandem, chromium-plated steel female piston rod with flange 3A = Double thrust tandem, stainless steel male piston rod 4A = Double thrust tandem, chromium-plated steel male piston rod	016 = Ø16 040 = Ø40 020 = Ø20 050 = Ø50 025 = Ø25 063 = Ø63 032 = Ø32	Upon request

Z = Stroke

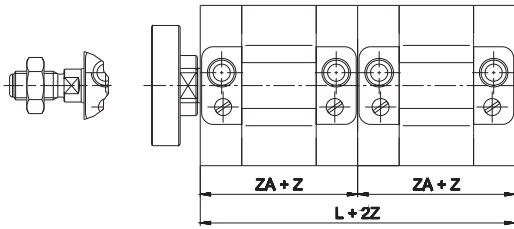

Ø	L	ZA
16	74	37
20	74	37
25	78	39
32	88	44
40	90	45
50	90	45
63	100	50
80	108	54
100	134	67

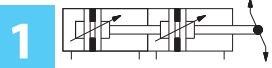

Tandem cylinders are constructed using two pistons coupled together which double the force in forward movement compared to the traditional cylinders of the same bore size

Two-position tandem version

CODIFICATION KEY

R	O	1	B	0	2	0	0	3	0	0	5	0
1	2	3	4	5								

1 Series	2 Type	3 Bore (mm)	4 Z1 stroke (mm)	5 Z2 stroke (mm)
RO = Ø16 ÷ 63 mm - UNITOP Compact Cylinders octagonal tube NON-ROTATING RN = Ø16 ÷ 63 mm - ISO 21287 Compact Cylinders octagonal tube NON-ROTATING	1B = Two-position tandem, stainless steel female piston rod with flange 2B = Two-position tandem, chromium-plated steel female piston rod with flange 3B = Two-position tandem, stainless steel male piston rod 4B = Two-position tandem, chromium-plated steel male piston rod	016 = Ø16 040 = Ø40 020 = Ø20 050 = Ø50 025 = Ø25 063 = Ø63 032 = Ø32	Upon request	Upon request

Z = Stroke

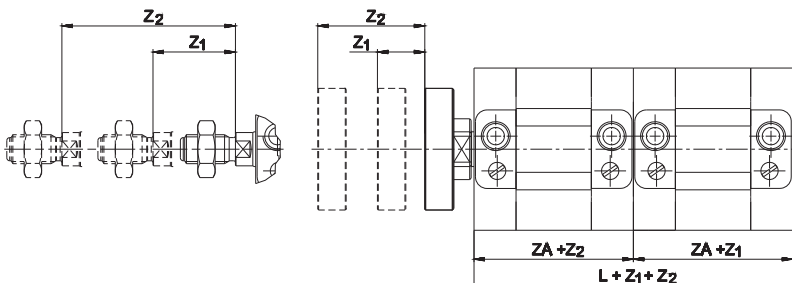

Ø	L	ZA
16	74	37
20	74	37
25	78	39
32	88	44
40	90	45
50	90	45
63	100	50
80	108	54
100	134	67

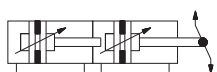

Two-position cylinders with two independent piston-rods which allow to realize a double positioning in which the thrust forces are the same as those of a cylinder of the same bore size

For all other dimensions please refer to the standard version
 For other types of cylinders kindly contact our sales office

Opposed tandem

CODIFICATION KEY

R	O	1	C	0	2	0	0	2	0	0	4	0
1	2	3	4	5								

1 Series	2 Type	3 Bore (mm)	4 Z1 stroke (mm)	5 Z2 stroke (mm)
RO = Ø16 ÷ 63 mm - UNITOP Compact Cylinders octagonal tube NON-ROTATING RN = Ø16 ÷ 63 mm - ISO 21287 Compact Cylinders octagonal tube NON-ROTATING	1C = Opposed tandem, stainless steel female piston rod with flange 2C = Opposed tandem, chromium-plated steel female piston rod with flange 3C = Opposed tandem, stainless steel male piston rod 4C = Opposed tandem, chromium-plated steel male piston rod	016 = Ø16 040 = Ø40 020 = Ø20 050 = Ø50 025 = Ø25 063 = Ø63 032 = Ø32	Upon request	Upon request

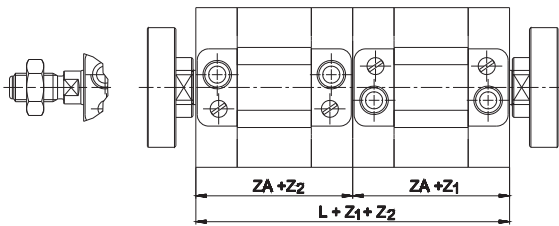

Type of cylinder characterized by the coupling of two cylinders and whose piston rods move in opposite directions. The values of the thrust force are the same as those of the traditional cylinders

Z = Stroke

Ø	L	ZA
16	74	37
20	74	37
25	78	39
32	88	44
40	90	45
50	90	45
63	100	50
80	108	54
100	134	67

With common piston rod tandem version (upon request)

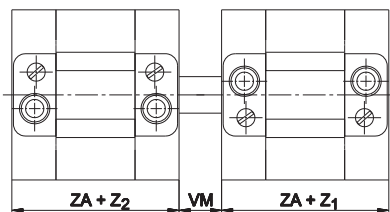

Two coupled cylinders with common piston rod.
The values of the thrust force are the same as those of the traditional cylinders

Z = Stroke

Ø	L	VM	ZA
16	74	10	37
20	74	10	37
25	78	12	39
32	88	14	44
40	90	14	45
50	90	16	45
63	100	16	50

For all other dimensions please refer to the standard version
For other types of cylinders kindly contact our sales office

Subject to change

Female rear hinge (ISO MP2) with pin

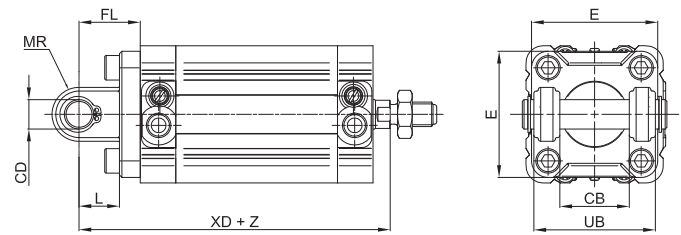
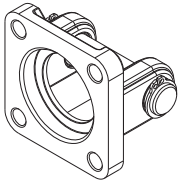

Material: Aluminium, zinc-plated steel pin

Z = Stroke

Ø	CB		C		E		FL		L		MR		UB		XD				Mass		Part no.		
	h14		h9				± 0,2		min		Max		h14						RO UNITOP	RN ISO	RO UNITOP	RN ISO	
16	-	-	-	-	-	-	-	-	-	-	-	-	-	-	-	-	-	-	-	-	-	-	-
20	-	-	-	-	-	-	-	-	-	-	-	-	-	-	-	-	-	-	-	-	-	-	-
25	-	-	-	-	-	-	-	-	-	-	-	-	-	-	-	-	-	-	-	-	-	-	-
32	26	26	10	10	48	48	22	22	12	12	11	11	45	45	73	73	± 1,25	± 1,25	75		KF-10032A		
40	28	28	12	12	54	54	25	25	15	16	13	12,5	52	52	77	77	± 1,25	± 1,25	110	156	RPF-10040A	KF-10040A	
50	32	32	12	12	65	65	27	27	15	16	13	12,5	60	60	80	80	± 1,25	± 1,25	150	200	RPF-10050A	KF-10050A	
63	40	40	16	16	75	75	32	32	20	21	17	15	70	70	90	90	± 1,6	± 1,6	270	362	RPF-10063A	KF-10063A	

Narrow female hinge with pin (DIN 648K)

1

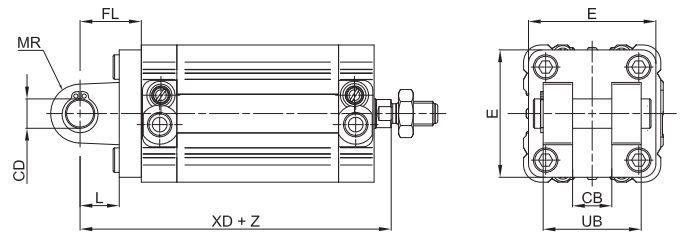
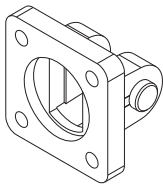

Material: Aluminium, zinc-plated steel pin

Z = Stroke

Ø	CB		CD	E	FL	L	MR	UB	XD		Mass	Part no.	
	h14								h9				
16	-	-	-	-	-	-	-	-	-	-	-	-	-
20	-	-	-	-	-	-	-	-	-	-	-	-	-
25	-	-	-	-	-	-	-	-	-	-	-	-	-
32	14	10	10	45	22	13	10	34	73	± 1,25	68	KF-10032AS	
40	16	12	12	52	25	16	12	40	77	± 1,25	112	KF-10040AS	
50	21	16	16	65	27	16	14	45	80	± 1,25	196	KF-10050AS	
63	21	16	16	75	32	21	18	51	90	± 1,6	288	KF-10063AS	

Rear male hinge (ISO MP4)

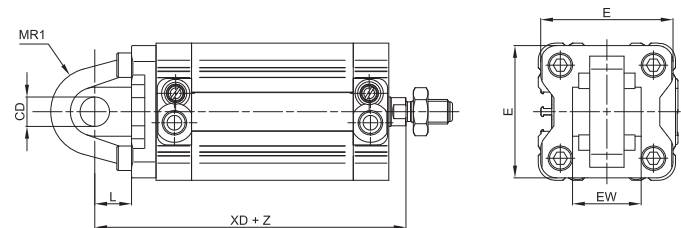
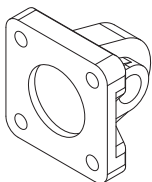

Material: Aluminium

Z = Stroke

Ø	CD	E	EW	L	MR1	XD		Mass	Part no.	
									RN ISO	
16	6	27	12	-0,2/- 0,6	10	6	58	± 1	17	RPF-11016
20	8	34	16	-0,2/- 0,6	14	8	63	± 1	21	RPF-11020
25	8	38	16	-0,2/- 0,6	14	8	65	± 1	27	RPF-11025
32	10	48	26	-0,2/- 0,6	12	15	73	± 1,25	80	KF-11032
40	12	54	28	-0,2/- 0,6	15	18	77	± 1,25	100	- KF-11040
50	12	65	32	-0,2/- 0,6	15	20	80	± 1,25	170	- KF-11050
63	16	75	40	-0,2/- 0,6	20	23	90	± 1,6	250	- KF-11063

Articulated rear male hinge (ISO MP4)

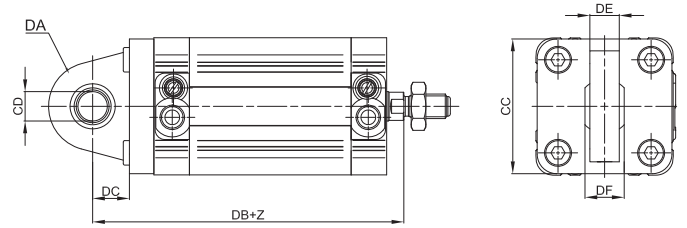
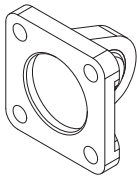

Material: Aluminium

Z = Stroke

Ø	CC	CD	DA	DB	DC	DE	DF	Mass g	Part no.	
									RO UNITOP	RN ISO
16	-	-	-	-	-	-	-	-	-	-
20	-	-	-	-	-	-	-	-	-	-
25	-	-	-	-	-	-	-	-	-	-
32	48	10	15	73	14	10,5	14	70	-	KF-110325
40	54	12	18	77	16,5	12	16	100	-	KF-100405
50	65	12	20	80	17,5	12	16	145	-	KF-100505
63	75	16	21	90	21,5	15	21	250	-	KF-100635

Front/rear flange

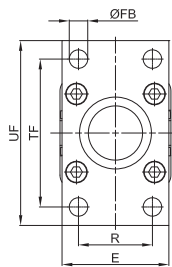
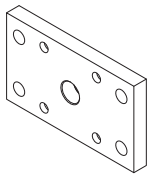

> Rear assembly

> Front assembly

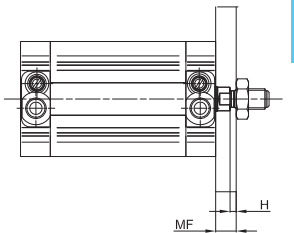
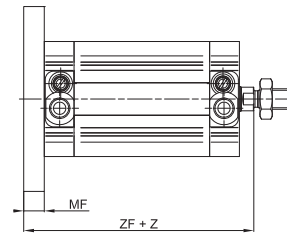

Material: Zinc-plated steel

Z = Stroke

Ø	Ø D		E		Ø FB		H		MF		R		TF		UF		ZF		ZH		Mass		Part no.			
	Ø h11				Ø h13						Js14		Js14								g		RO UNITOP		RN ISO	
16	10	-	29	-	4,5	-	5	-	10	-	-	-	43	-	55	-	52	-	47	-	100				RPF-12016	
20	12	-	36	-	6,6	-	4	-	10	-	-	-	55	-	70	-	53	-	47	-	160				RPF-12020	
25	12	-	40	-	6,6	-	4	-	10	-	-	-	60	-	76	-	55	-	49	-	200				RPF-12025	
32	14	30	50	45	7	7	3	3	10	10	32	32	65/64	64	80	80	61	61	54	54	260				RPF-12032	
40	14	35	60	52	9	9	3	3	10	10	36	36	82/72	72	102	90	62	62	55	55	420	250			RPF-12040	KF-12040
50	18	40	68	65	9	9	4	4	12	12	45	45	90	90	110	110	65	65	57	57	600	500			RPF-12050	KF-12050
63	18	45	87	75	9	9	7	4	15	12	50	50	100	100	130	120	73	70	65	63	1200	650			RPF-12063	KF-12063

Angle bracket

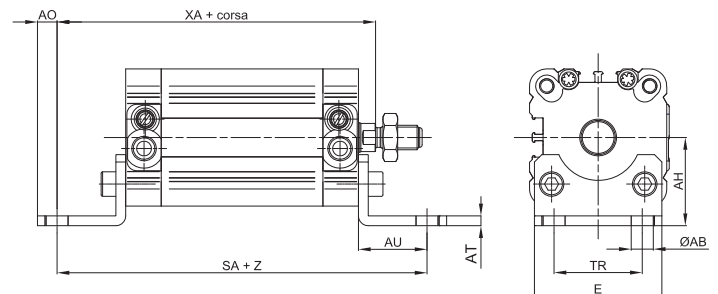
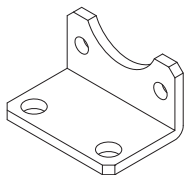

Material: Zinc-plated steel

Z = Stroke

Ø	Ø AB		Ø AH		AO		AT		AU		E		SA		TR		XA		Mass		Part no.				
	Ø h13		Js15		Js15														g		RO UNITOP		RN ISO		
16	5,5	-	22	-	4,5	-	3	-	13	-	30	-	63	-	18	-	55	-	20					RPF-13016	
20	6,6	-	27	-	6	-	4	-	16	-	36	-	69	-	22	-	59	-	30					RPF-13020	
25	6,6	-	30	-	6	-	4	-	16	-	40	-	71	-	26	-	61	-	40					RPF-13025	
32	6,6	7	32,25	32	8	6	5	4	18	24	50	45	80	92	32	32	69	75	70					RPF-13032	
40	6,6	9	42,5	36	8	8	5	4	20	28	60	52	85	101	42	36	72	80	100					RPF-13040	KF-13040
50	9	9	47	45	8	10	6	5	24	32	68	64	93	109	50	45	77	85	150					RPF-13050	KF-13050
63	9	9	59,5	50	12	12	6	5	27	32	84	74	104	114	62	50	85	93	250					RPF-13063	KF-13063

ISO intermediate hinge

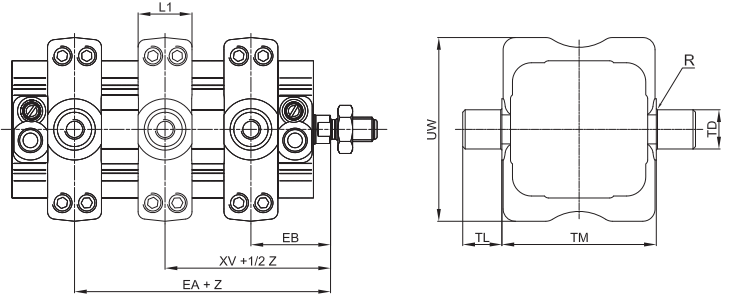
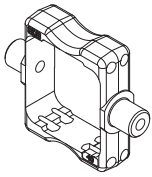

Material: Zinc-plated steel

Z = Stroke

Ø	EA	EB	L1	R	TD	TL	TM	UW	XV		Mass	Part no.		
	Max	min	Max	Max	e9	h14	h14	Max				g	RO UNITOP	RN ISO
16	-	-	-	-	-	-	-	-	-	-	-	-	-	-
20	-	-	-	-	-	-	-	-	-	-	-	-	-	-
25	-	-	-	-	-	-	-	-	-	-	-	-	-	-
32	24	34	22	0,5	12	12	50	65	29	± 2	130	-	KDF-14032	
40	25	34	22	0,5	16	16	63	75	29,5	± 2	240	-	RPF-14040	
50	26	35	22	1	16	16	75	95	30,5	± 2	320	-	RPF-14050	
63	27	38	28	1	20	20	90	105	32,5	± 2	470	-	RPF-14063	

Front/rear hinge with floating pin

1

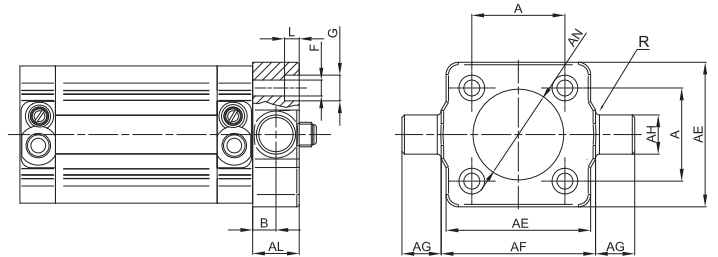
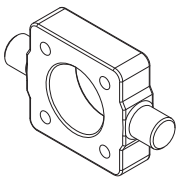

Material: Zinc-plated steel

Ø	AE	AL	AH	AG	AF	AN	A	B	F	G	L	R	Mass	Part no.	
	Max	Max	e9	h14	h14	h11	± 0,2	± 0,2/0	h13	h13	± 0,5/0	0/± 0,3		g	RO UNITOP
16	-	-	-	-	-	-	-	-	-	-	-	-	-	-	-
20	-	-	-	-	-	-	-	-	-	-	-	-	-	-	-
25	-	-	-	-	-	-	-	-	-	-	-	-	-	-	-
32	46	14	12	12	50	30	32,5	6,5	6,5	-	6	1	137	-	KF-14032AP
40	59	19	16	16	63	35	38	9	6,5	10,5	6	1,6	385	-	KF-14040AP
50	69	19	16	16	75	40	46,5	9	8,5	13,5	8	1,6	513	-	KF-14050AP
63	84	24	20	20	90	45	56,5	11,5	8,5	13,5	8	1,6	1041	-	KF-14063AP

Counter hinge 90°

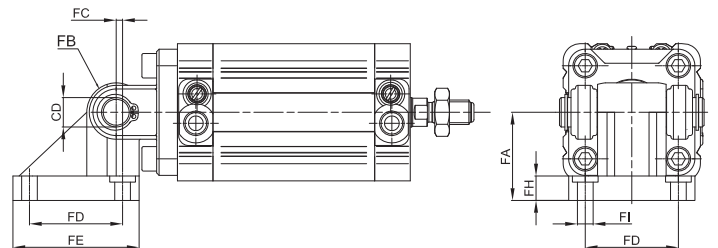
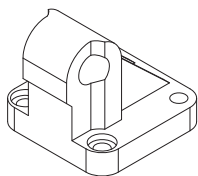

Material: Aluminium

Ø	CD	FA	FB	FC	FD	FE	FG	FH	FI	F1	F2	Mass	Part no.	
	h9	J515					- 0,2/- 0,6						g	RO UNITOP
16	-	-	-	-	-	-	-	-	-	-	-	-	-	-
20	-	-	-	-	-	-	-	-	-	-	-	-	-	-
25	-	-	-	-	-	-	-	-	-	-	-	-	-	-
32	10	32	10	1,2	32,5	46,5	26	9	6,4	5,5	10,5	90	-	KF-19032
40	12	36	12	2,6	38	51,5	28	9	6,6	5,5	10,5	120	-	KF-19040
50	12	45	12	0,3	46,5	63,5	32	9	8,4	5	13,5	200	-	KF-19050
63	16	50	16	3,3	56,5	73,5	40	10,5	8,4	5	13,5	320	-	KF-19063

Counter hinge 90° (CETOP)

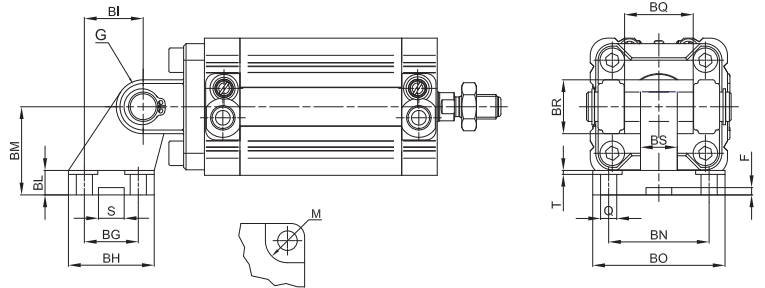
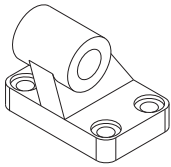

Material: Aluminium

Z = Stroke

Ø	Q	M	BG	BH	BI	BL	BM	BN	BO	BS	BR	T	G	S	F	BQ	Mass	Part no.
	h13	h13	Js14	Max	Js14		Js15	Js14	Max	Max	Max	Max	h9	+ 0,5/0	+ 0,5/0		g	
16	-	-	-	-	-	-	-	-	-	-	-	-	-	-	-	-	-	-
20	-	-	-	-	-	-	-	-	-	-	-	-	-	-	-	-	-	-
25	-	-	-	-	-	-	-	-	-	-	-	-	-	-	-	-	-	-
32	6,6	11	18	31	21	8	32	38	51	10	20	1,6	10	10,5	3	26	56	KF-19032CTA
40	6,6	11	22	35	24	10	36	41	54	15	22	1,6	12	10,5	3	28	139	KF-19040CTA
50	9	15	30	45	33	12	45	50	65	16	26	1,6	12	10,5	3	32	142	KF-19050CTA
63	9	15	35	50	37	14	50	52	67	16	30	1,6	16	10,5	3	40	200	KF-19063CTA

Counter hinge 90° (CNOMO)

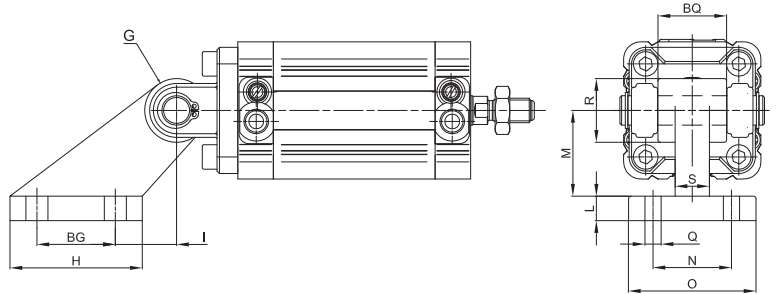
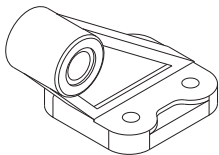

Material: Aluminium

Ø	Q	BG	H	I	L	M	N	O	S	R	BQ	G	Mass	Part no.
	h13	± 0,2		± 0,2		± 0,2	± 0,2			Max	± 0,2/± 0,1	h9	g	
16	-	-	-	-	-	-	-	-	-	-	-	-	-	-
20	-	-	-	-	-	-	-	-	-	-	-	-	-	-
25	-	-	-	-	-	-	-	-	-	-	-	-	-	-
32	7	20	37	18	8	32	25	41	9	19,5	25	8	58	KF-19032CN
40	9	32	54	25	10	45	32	52	14	26	32	12	144	KF-19040050CN
50	9	32	54	25	10	45	32	52	14	26	32	12	144	KF-19040050CN
63	11	50	75	32	13	63	40	63	14	32	46	16	300	KF-19063080CN

Counter hinge 90°

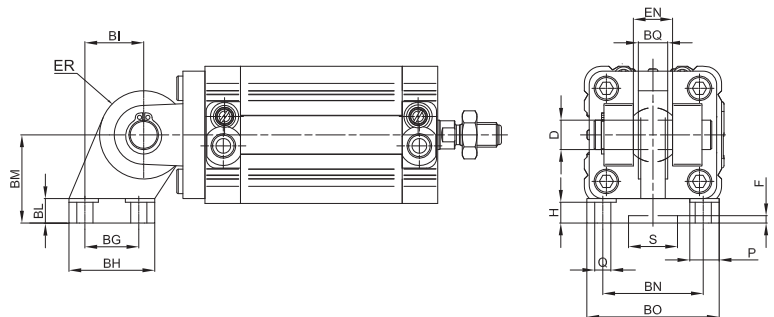
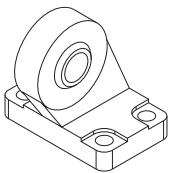

Material: Aluminium

Ø	Q	P	BG	BH	BI	BL	BM	BN	BO	EN	ER	BQ	D	H	S	F	Mass	Part no.
	h13	h13	Js14	Max	Js15		Js15	Js14	Max	0/- 0,1	Max	Max	h7	+ 0,5/0	h13		g	
16	-	-	-	-	-	-	-	-	-	-	-	-	-	-	-	-	-	-
20	-	-	-	-	-	-	-	-	-	-	-	-	-	-	-	-	-	-
25	-	-	-	-	-	-	-	-	-	-	-	-	-	-	-	-	-	-
32	6,6	11	18	31	21	10	32	38	51	14	15	10,5	10	8,5	20	3	58	KF-19032SC
40	6,6	11	22	35	24	10	36	41	54	16	18	12	12	8,8	20	3	144	KF-19040SC
50	9	15	30	45	33	12	45	50	65	21	20	15	16	10,5	20	3	144	KF-19050SC
63	9	15	35	50	37	12	50	52	67	21	23	15	16	10,5	20	3	300	KF-19063SC

Hinge support

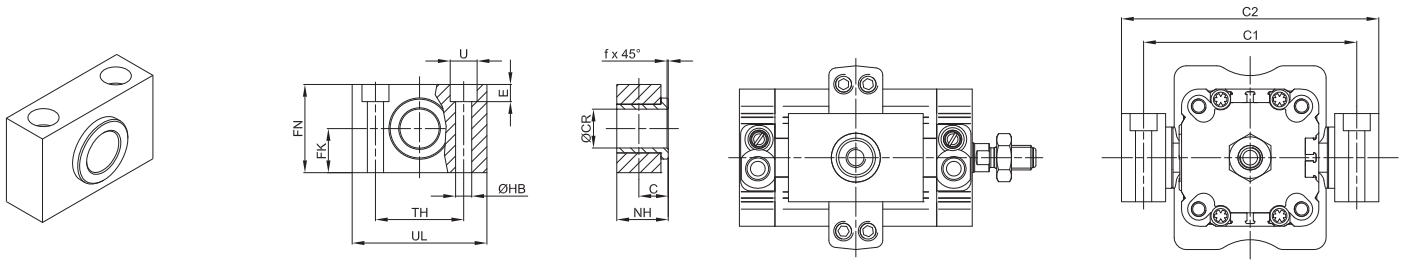

Material: Anodized aluminium and brass bushing

Ø	C	CR	FK	FN	HB	NH	TH	UL	U	E	F	C1	C2	Mass g	Part no.
32	10,2	12	15 ± 0,1	30	6,6	18	± 0,1	46	11	7 ± 0,5	1	71	86	110	KF-41032
40-50	12	16	18	36	9	21	36	55	15	9	1,6	Ø40 87 Ø50 99	Ø40 105 Ø50 117	200	KF-41040050
63	13	20	20	40	11	23	42	65	18	11	1,6	Ø63 116 Ø80 136	Ø63 136 Ø80 156	267	KF-41063080

Pin with 2 circlips

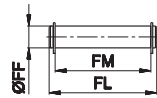

Material: Zinc-plated steel

Cylinder Ø	FF	FL	FM	Mass g	Part no.
32	10	53	46	30	KF-18032
40	12	61,3	53	50	KF-18040
50	12	69	61	50	KF-18050
63	16	80,5	71	120	KF-18063
80	16	100,5	91	150	KF-18080
100	20	122,5	111	290	KF-18100

> Fixing screws

Cylindrical screw
UNI 5931 suitable for
mounting elements
Series RPF-12.../RPF-13.../RPF-11...

Cylinder Ø	Screw	Part no.
16	M4x18	AZ4-VN0418
20 - 25	M5x18	AZ4-VN0518
32 - 40	M6x20	AZ4-VN0620
50 - 63	M8x25	AZ4-VN0825
80	M10x30	AZ4-VN1030
100	M10x30	AZ4-VN1030

Cylindrical screw
UNI 5931 suitable for
mounting elements
Series KF-10032/RPF-10...

Cylinder Ø	Screw	Part no.
32 - 40	M6x25	AZ4-VN0625
50 - 63	M8x30	AZ4-VN0830
80	M10x30	AZ4-VN1030
100	M10x30	AZ4-VN1030

Pin for narrow hinge

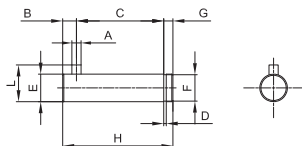

Material: Zinc-plated steel

Ø	A	C	D	E	F	G	H	L	B	Part no.
32	3	32,5	1,1	10	9,6	4	41	14	4,5	KF-18032S
40	4	38	1,1	12	11,5	4	48	16	6	KF-18040S
50	4	43	1,1	16	15,2	5	54	20	6 0	KF-18050S
63	4	49	1,1	16	15,2	5	60	20	6 -1	KF-18063S
80	4	63	1,3	20	19	6	75	24	6	KF-18080S
100	4	73	1,3	20	19	6	85	24	6	KF-18100S

Female fork with clips

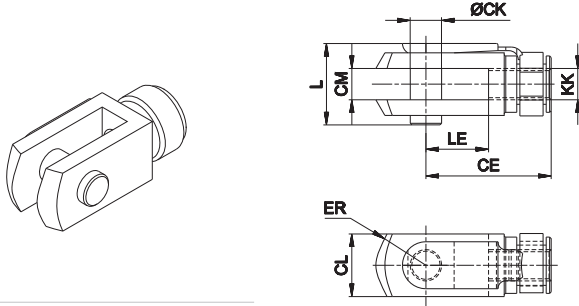

Material: Zinc-plated steel

Cylinder Ø	CE	CK	CL	CM	ER	KK	L	LE	Mass g	Part no.
16	24	6	12	6	7	M6x1	16	12	19	MF-15012
20 - 25	32	8	16	8	10	M8x1,25	22	16	46	MF-15020
32 - 40	40	10	20	10	16	M10x1,25	26	20	90	KF-15032
50 - 63	48	12	24	12	19	M12x1,25	32	24	150	KF-15040

Fork with pin suitable for piston rod according to ISO 8140 standard

Articulated self-lubricating fork

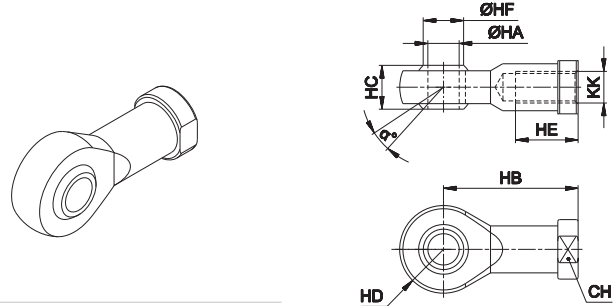

Material: Zinc-plated steel

Cylinder Ø	α°	CH	KK	HA	HB	HC	HD	HE	HF	Mass g	Part no.	
16	13	11	M6x1	H7	6	30	9	10	12	9	26	MF-17012
20 - 25	13	14	M8x1,25	8	36	12	12	16	10,4	46	MF-17020	
32 - 40	13	17	M10x1,25	10	43	14	14	20	12,9	76	KF-17032	
50 - 63	13	19	M12x1,25	12	50	16	16	22	15,4	110	KF-17040	

Fork with axially mounted articulated pin

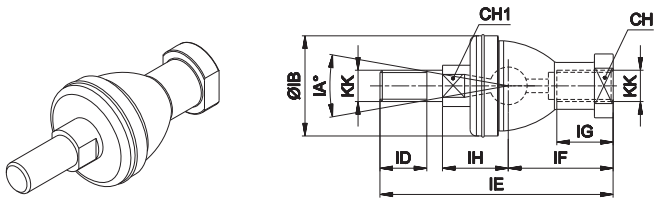

Material: Zinc-plated steel

Cylinder Ø	CH	CH1	IA°	KK	IH	IB	ID	IE	IF	IG	Mass g	Part no.
16	11	8	30	M6x1	12,2	22	11	55,2	28	15	40	MF-22016
20 - 25	14	10	30	M8x1,25	16	28	12	65	32	16	75	MF-22020
32 - 40	17	11	30	M10x1,25	19,5	32	15	74,5	35	18	120	KF-22025
50 - 63	19	17	30	M12x1,25	22	36	17	84	40	20	185	KF-22040

Fork with angle mounted articulated pin

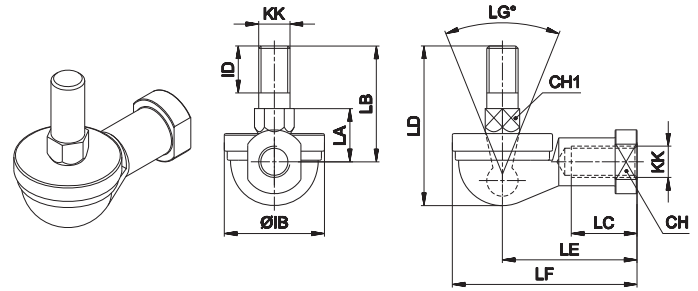

Material: Zinc-plated steel

Cylinder Ø	CH	CH1	LG°	KK	IB	ID	LA	LB	LC	LD	LE	LF	Mass g	Part no.
16	11	8	50	M6x1	22	11	11	26	14	35,5	30	40	37	MF-23012
20 - 25	14	10	50	M8x1,25	28	12	14	31	17	42,5	36	48	67	MF-23020
32 - 40	17	11	50	M10x1,25	32	15	17	37	21	50,5	43	57	110	KF-23025
50 - 63	19	17	50	M12x1,25	36	17	19	42	27	57,5	50	66	165	KF-23040

Floating joint

Piston rod locknut (zinc-plated steel)

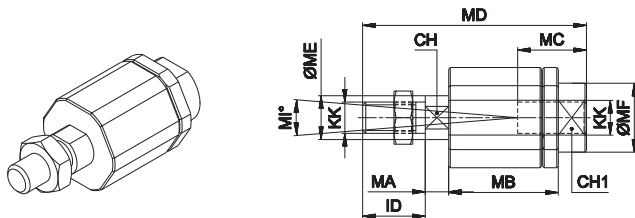

Material: Zinc-plated steel

Cylinder Ø	CH	CH1	ID	KK	MA	MB	MC	MD	ME	MF	MG	MH	MI°	Mass g	Part no.
16	5	7	11	M6x1	2,5	17,5	12,5	35	6	8,5	13	14,5	6	35	MF-24012
20 - 25	7	11	21	M8x1,25	5	26	16	57	8	12,5	17	19	8	60	MF-24020
32 - 40	12	19	71	M10x1,25	5	35	20	71	14	22	30	32	8	220	KF-24032
50 - 63	12	19	75	M12x1,25	5	35	20	75	14	22	30	32	8	230	KF-24040



Material: Zinc-plated steel

Cylinder Ø	KK	KV	KW	Mass g	Part no.
16	M6x1	10	4	1,6	MF-16012
20 - 25	M8x1,25	13	5	3,4	MF-16020
32 - 40	M10x1,25	17	6	5	KF-16032
50 - 63	M12x1,25	19	7	10	KF-16040