

LKP010-2324/2325

□ 19 mm - offset 75 mm

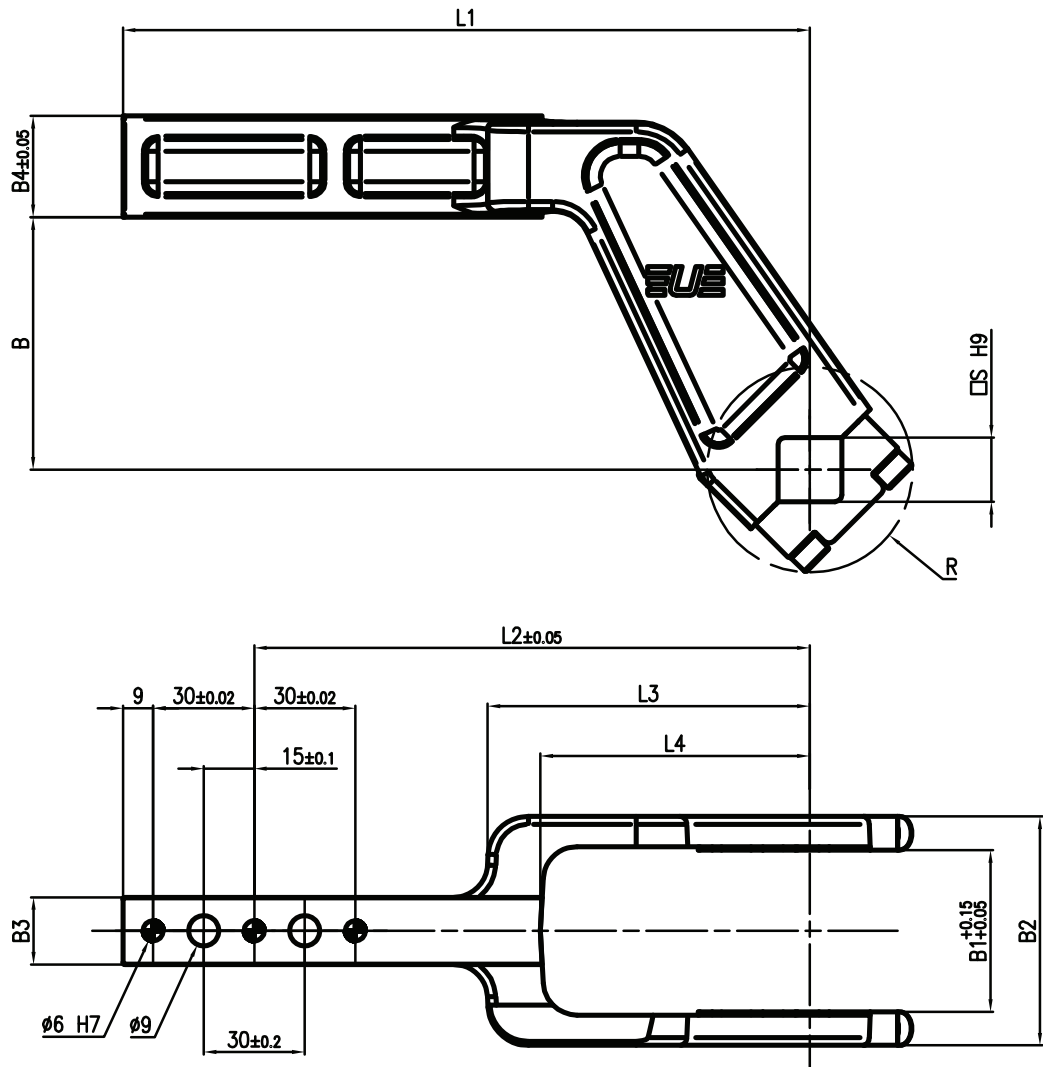

Artikelnr.	B	B1	B2	B3	B4	L1	L2	L3	L4	R	S	Material
LKP010-2324	75	48	68	20	30	144	105	95	80	31	19	Stahl
LKP010-2325	75	48	68	20	30	204	165	95	80	31	19	Stahl