

PNEUMATIC AUTOMATION

CYLINDERS
HIGH-TECH
VALVES
AIR TREATMENT
ACCESSORIES



AUTOMOTIVE

POWER CLAMPS
PIN UNITS
PIN CLAMPS
GRIPPER UNITS
POWER PIVOTS
MARKING UNITS
ELECTRIC UNITS



MODULAR TOOLING SYSTEM

GR8 TOOLING

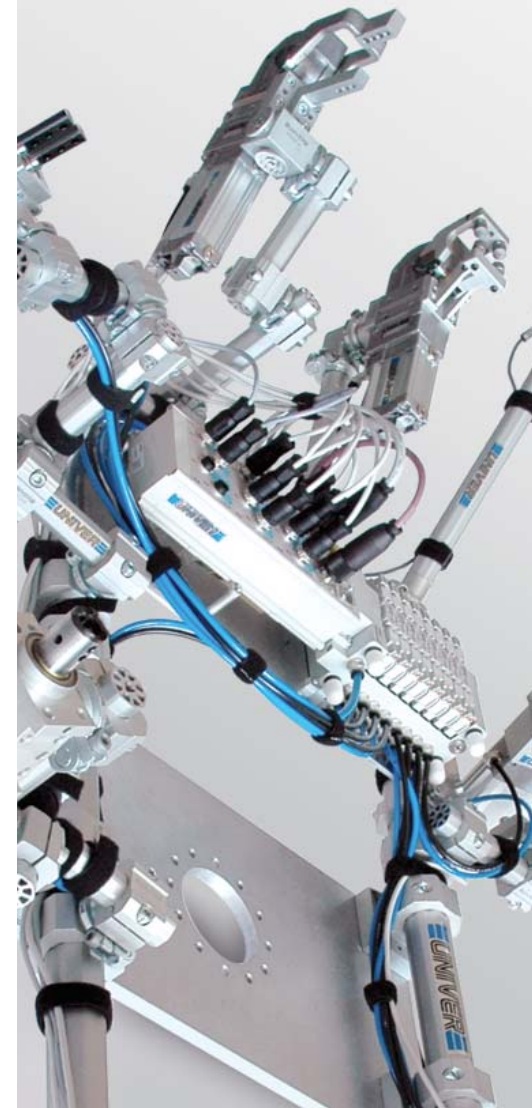



Early stages

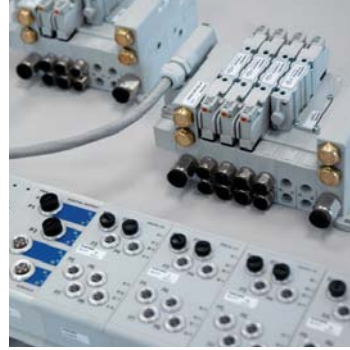

Pneumatic



Automotive



GR8 Tooling

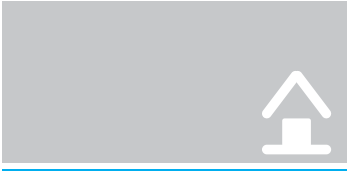

UNIVER has started its activity in the field of industrial automation during the 1970s, with the production of its first series of pneumatic valves and poppet valves for vacuum.



In the following decades, the widening range of technologically advanced and original pneumatic components has allowed the continuous growth and development of the company, which has become one of the major Italian businesses in the production of industrial automation equipment.



In 2000, after many years of experience in the supply of pneumatic components to the automotive market, the Automotive Division was created, thus developing numbers of solutions for BIW in the automotive industry.



New entry, the Division of Modular Tooling Systems (GR8) represents the new challenge in the press field and handling of metal sheets in Automotive and Industrial Automation.

Some of our customers



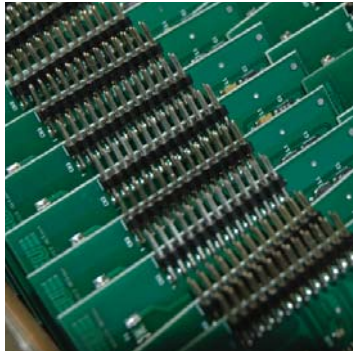

Electronic



The Electronic Division, supporting both Pneumatic Automation and Automotive divisions, is specialized in the study, design and manufacturing of the electric and electronic devices which are integrated in UNIVER products.



Univer Service



In Italy, the commercial company **UNIVER SERVICE S.r.l.** controls the domestic market and guarantees a quick and efficient service, thanks to different operational offices and distributors in the whole country.



Univer Group



The UNIVER Group has many direct branches and an active distribution network covering the most important industrialized areas.



Innovation
Research and Development
Quality
Training
Communication

www.univer-group.com



STANDARDS-BASED CYLINDERS

M

Microcylinders ISO 6432
 $\varnothing 8 \div 25$ mm



KL

Pneumatic Cylinders ISO 15552
 $\varnothing 32 \div 125$ mm
CLEAN PROFILE



KE/K

Pneumatic Cylinders ISO 15552
 $\varnothing 32 \div 125$ mm



STANDARDS-BASED COMPACT CYLINDERS

RP/RM

UNITOP Compact Cylinders (RP $\varnothing 16 \div 63$ mm),
 ISO 21287 (RM $\varnothing 16 \div 100$ mm)



RO/RN

UNITOP Compact Cylinders (RO $\varnothing 16 \div 63$ mm),
 ISO 21287 (RN $\varnothing 16 \div 63$ mm) - Octagonal tube
NON-ROTATING



OVAL/SHORT STROKE/ROTARY CYLINDERS

OV

Oval cylinder
 $\varnothing 18 \div 80$ mm



W

Short stroke cylinders
 $\varnothing 12 \div 100$ mm
TUBE NEW DESIGN



R

Pneumatic Rotary Actuators
 $\varnothing 32 \div 125$ mm



PNEUMATIC AUTOMATION CYLINDERS

KD

Pneumatic Cylinders ISO 15552
Ø32 ÷ 125 mm
HEAVY SERIES TUBE



K

Pneumatic Cylinders ISO 15552
Ø160/200 - 250/320 mm



KL

CLEAN PROFILE

Easier to clean

QUICK INSTALLATION

Sensors and connections on one side

UNIVER TECHNOLOGY

Strong and Reliable

ISO 15552

Interchangeability

RS

STRONG Compact Cylinders
Ø32 ÷ 100 mm



RQ

STRONG Compact Cylinders
Ø32 ÷ 100 mm - Octagonal Tube
NON-ROTATING



SENSORS

MP

Clamping cylinder



DF/DH

Magnetic and Electronic
Proximity Sensors



RODLESS CYLINDERS

S1

Rodless Cylinders standard version
 Ø16 ÷ 50 mm



S5

Rodless Cylinders with integrated guides
 Ø25 ÷ 50 mm
 Technopolymer sliding guides

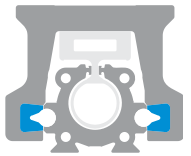

GUIDED CYLINDERS

J1

Slide Units for pneumatic cylinders
 M, KE/K, KD series



J3

Slide Units for rodless cylinders
 S1 series

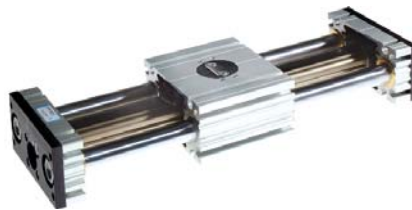

J64RS

Slide Units for STRONG compact cylinders
 RS series



J65

Slide Units for compact cylinders
 RP Ø25 series



JLS/JLV

Guided Compact Cylinders
 Bearings (JLS) - Ball bushing (JLV)



Version with metallic
 piston rod scraper
 (Upon request)

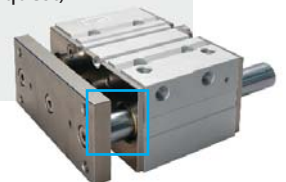

**CYLINDER
 ASSEMBLY KITS**



M/KL/K/KE/KD



RP/RM-RO/RN

PNEUMATIC AUTOMATION CYLINDERS

S1/S5/VL1

UNIVER Original since 1988

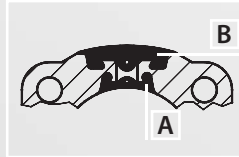

A - Internal strip (seal)
B - External strip (protection)
made of reinforced elastomer
with Kevlar fiber



VL1

Rodless Cylinders with 90° integrated guides
Ø25 ÷ 50 mm
Sliding on ball bearings

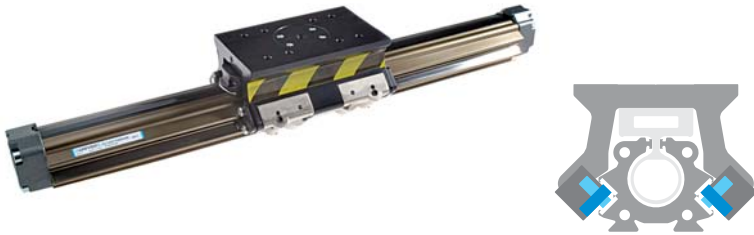

J64RT2

Slide Units for telescopic cylinders
RT2 series



JT/JX

Guided Slides



RS/RQ

S1/S5/VL1

LOCKING UNITS

L1-N

Locking units for cylinders and piston rods



ORIGINAL
Locking system
UNIVER Original since 1998

STATIC/DYNAMIC
Static locking and dynamic braking in a single device

POWERFUL
The highest locking force among market equivalent devices

SAFE
No rod slipping even if affected by oil and grease

L6

Locking Units for rodless cylinders S5 - VL1 series



PROGRAMMABLE PNEUMATIC ACTUATORS

NTZ

Pneumatic actuator with integrated digital measuring detector and safety locking device



NQZ

Pneumatic actuator with digital measuring system



PNEUMATIC GRIPPERS

YMA10/YMP10

Angular and Parallel Pneumatic Gripper



YMA20

Angular Pneumatic Gripper 180°



YMP20

Parallel Pneumatic Gripper with Linear Guide



YMP30

Low Profile Parallel Pneumatic Gripper with Linear Guide



PNEUMATIC AUTOMATION

HIGH-TECH

RT

ORIGINAL

UNIVER Original design and technology

INDUSTRIALIZED

Industrialized components and advanced technology

REDUCED DIMENSIONS

60% less than standard cylinders

NON-ROTATING

Anti-rotation octagonal tube standard supplied

TELESCOPIC CYLINDERS

RT

Telescopic cylinders

2 stages (RT2 Ø25 ÷ 63 mm) 3 stages (RT3 Ø40 ÷ 63 mm)



Telescopic Cylinder
2 stages

NFZ

Pneumatic actuator with integrated safety locking device



YMP40

Wide-type Parallel Pneumatic Gripper



YMP50

Self-centering 3 Jaw Pneumatic Gripper



Telescopic Cylinder
3 stages



ELECTROPILOTS

B11- B10 - B12

ISO 15218 - 10 mm Nanovalves
 B11 Standard
 B10 Low consumption
 B12 High flow rate



B

10 mm Nanovalves



A

ISO 15218 - 15 mm Microvalves



STANDARDS-BASED VALVES

BE/BE12

ISO 5599/1 Valves- Mixed and spool system

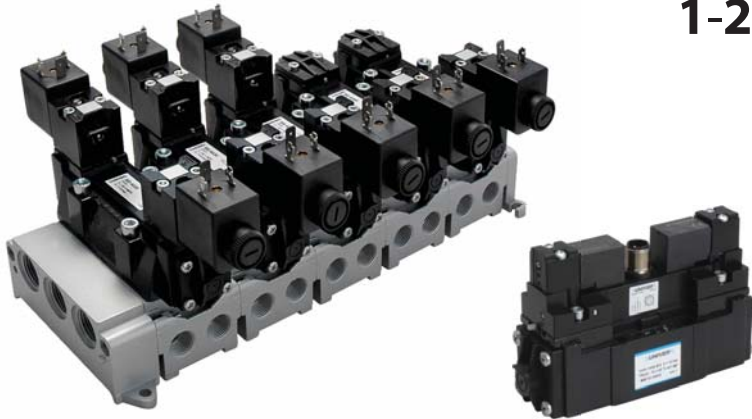

M12

Size
1-2-3-4

MIXED AND SPOOL SYSTEM

Versions with either mixed or spool system available for all series



MIXED
for heavy applications



SPOOL
for all applications

AC-N

NAMUR Valves



BD

ISO 15407-1/2 Valves

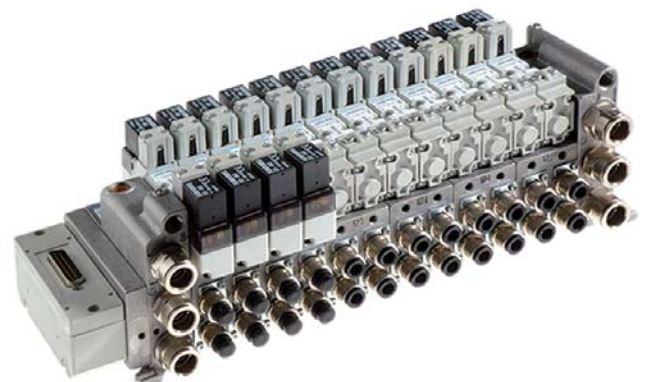

PNEUMATIC AUTOMATION VALVES

AA

U1 Miniature Electropilots



AB

U2 Miniature Electropilots



Sub-base with
integrated electrical
connection

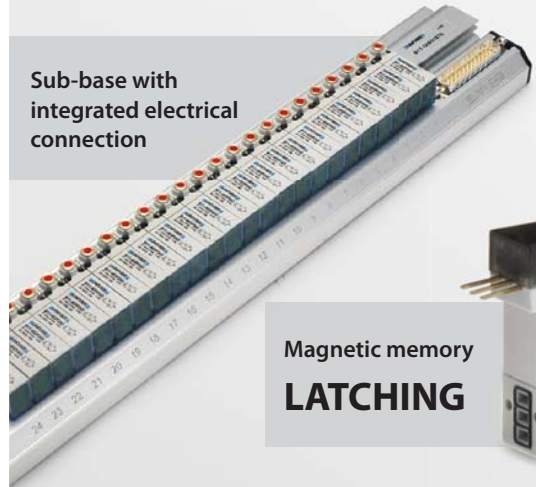

Magnetic memory
LATCHING



AE

ISO 5599/1 Light Series Valves



Size
1-2

ISO 15407-1/2 Valves

BDE

Integrated electrical
connection
(ISO 15407/2)

BDB

M12 connector
(Automotive)

BDA

Single electrical
connection
(ISO 15407/1)



ISO
01-02



18 mm (ISO 02)



26 mm (ISO 01)

SPOOL VALVES

CL/CM

UNIVERSAL Valves G1/8 - G1/4



E/F

COMPA 2 (E series) COMPA 4 (F series)
Miniature Valves



G7

Valves and Solenoid Valves 26 mm - G1/8



G6

20 mm - Valves and Solenoid Valves - Threaded body G1/8



POPPET VALVES

AF/AG

Poppet Valves for compressed air (AF)
and for vacuum (AG) G1/8 ÷ G1 1/2



CH

Poppet valves G1/8
2/2 - 3/2



AI/AI-JET

Miniature Limit Switches (AI)
JET series Pneumatic Switches (AI-JET)
Valves with panel operation (AI-JET2)



PNEUMATIC AUTOMATION VALVES

PS

COMBOBOX Valves



AF/AG

Poppet system
UNIVER Original since 1973

GL6

20 mm - Valves and Solenoid Valves - For sub-base mounting



MIXED Valves - AC series

MIXED SYSTEM

For heavy applications
Fast commutation
Large number of cycles
High flow rate



AM

Pneumatic and Solenoid
Foot Valves



AC

MIXED Valves
G1/8 - G1/4 - G1/2



COMPACT VALVES

P10F

10 mm COMPACT Valves - M5



P10B

10 mm COMPACT Valves - For sub-base mounting



P15F

15 mm COMPACT Valves - G1/8



P15B

15 mm COMPACT Valves - For sub-base mounting

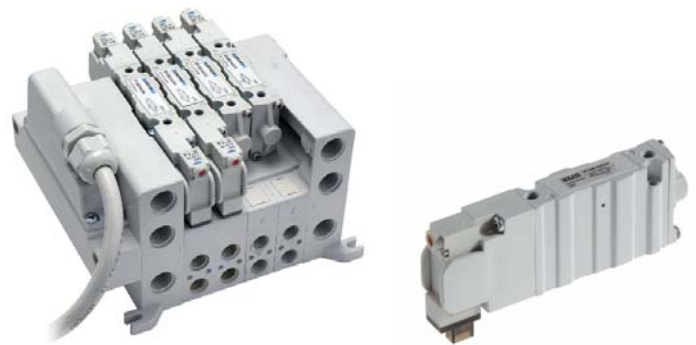

P10F

10 mm COMPACT Valves
External connector



In-line
CONNECTOR

P15F

15 mm COMPACT Valves
External connector

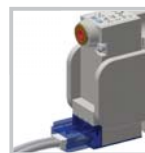

In-line
CONNECTOR

P15EF

15 mm COMPACT Valves - G1/8



SERIAL SYSTEMS

TC

Serial communication system



Serial module
for all manifold
models



CANopen

PROFI
BUS

PROFI
NET

EtherNet/IP

DeviceNet

EtherCAT

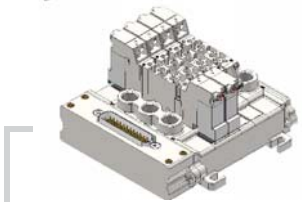

P10F

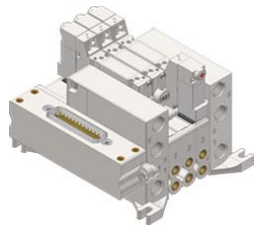

P10B

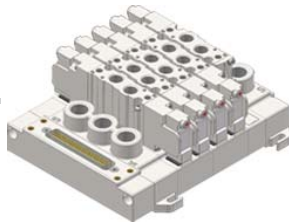

P15F



P15B

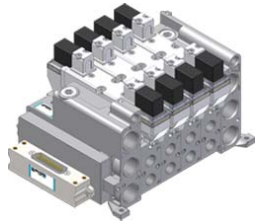

BD - 18 mm

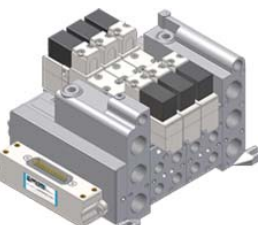

BD - 26 mm

PNEUMATIC AUTOMATION

VALVES

P10/P15

HIGH FLOW RATE

UNIVER traditional spool technology

COMPACT SIZE

Highest reduction of overall dimensions

EASY INSTALLATION

All pneumatic connections on the same side

COMPLETE SOLUTION

Threaded body and body for sub-base
mounting

5/2 - 5/3 - 3/2+3/2



AIR TREATMENT UNITS

HZE-F

Filter
size 0



HZE-R

Regulator
size 0



HZE-L

Lubricator
size 0



HZE-B

Filter regulator
size 0



HZE-F

Filter
size 1-2



HZE-R

Regulator
size 1-2



HZE-L

Lubricator
size 1-2



HZE-B

Filter regulator
size 1-2



HZE-Y

Gradual starter
size 0-1-2



HZE-N

Diverter block
size 0-1-2



HZE-P

Lockable valve
size 0-1-2



HZE-S

Shut-off valve
size 0-1-2



PNEUMATIC AUTOMATION

AIR TREATMENT

MODULAR

40 mm (HZE0) 63 mm (HZE1) 80 mm (HZE2)

INTEGRATED GAUGE

Standard supplied

COMPLETE SOLUTION

Possibility of assembling combinations complete with accessories

HZE-D

Filter regulator + Lubricator
size 0



HZE-C

Filter + Regulator + Lubricator
size 0



HZE-D

Filter regulator + Lubricator
size 1-2



HZE-C

Filter + Regulator + Lubricator
size 1-2



HZ9464G

Integrated square pressure gauge



HZ9P...

Round gauge



AIR TREATMENT UNITS

G1/4 Size 0	G3/8 - G1/2 Size 1	G1/2 Size 2
 <p>FR+L 600 NI/min</p>	 <p>FR+L 2800 NI/min</p>	 <p>FR+L 4300 NI/min</p>

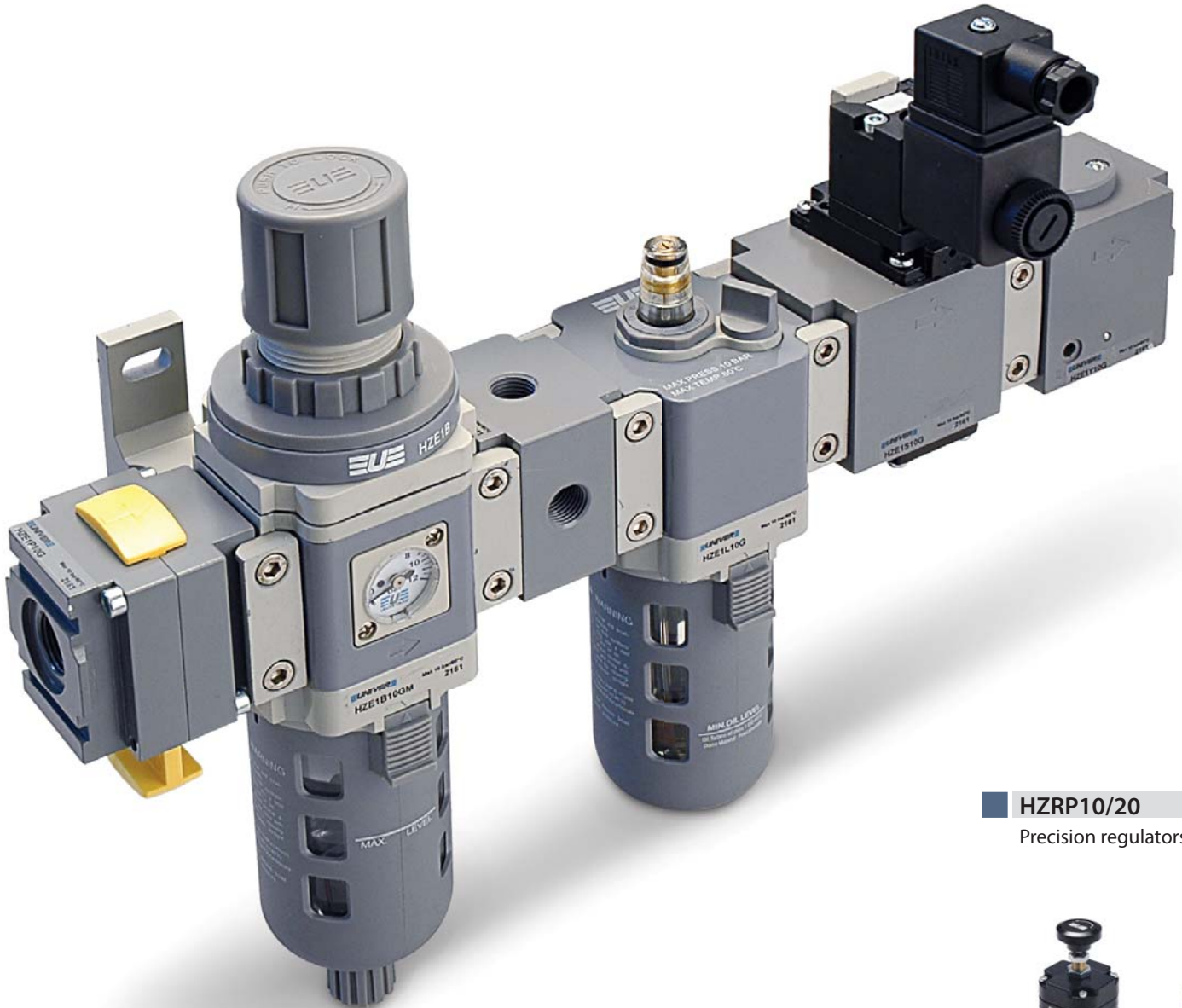

HZRP10/20
Precision regulators



PNEUMATIC AUTOMATION AIR TREATMENT

HZE0R08G

Regulator without manometer
Size 0



HZE-RL

Lockable regulator
size 1-2



HZE-R

Check valve
Size 0-1-2



HZE-B

Check valve
Size 0-1-2



HZE-S

Size 0 U05

Size 1 U05

Size 1 U3 CNOMO



HZRE10/20

Electro-pneumatic
transducers



HZRM08G

Microregulators
for air



HZRM...

Pressure Microregulators
for air and water



Filter regulator with digital pressure switch



FITTINGS AND TUBES

- HA** Technopolymer Push-In Fittings
- HAR** Space-saving Fittings
- HB** Nickel-plated Brass Push-in Fittings



- HGC** Push-on Fittings
- HGO** Olive Compression Fittings
- HGU** Quick Couplings for Compressed Air



COMPLEMENTARY VALVES AND ACCESSORIES

- AP** Binary Counter (Flip Flop)
- AM-50** Flow regulators with metallic body
- AM-51** Signal processing valve



- AM-54** Check valve
- AM-55** Blocking valve
- AM-5200** Pneumoelectrical transducer
- AM-5220** Adjustable pressure switch



PNEUMATIC AUTOMATION ACCESSORIES

HC

Fittings and Accessories with
pneumatic functions



HD

Standard fittings



HEA/HEC/HED

HEA Polyamide tubes
HEC Polyurethane tubes
HED Co-polyurethane tubes



HFA/HFC

HFA Polyamide Spiral Tubes
HFC Polyurethane Spiral Tubes



AM-52

Gradual starter



AM-53

Economizer



HZ9N

Digital pressure
switch



HZ9N12

Adjustable diaphragm
pressure switch



YF

G1/8 ÷ G1
Fluid Valves















Air/Oil reservoir
RMS series

NEW



POWER CLAMPS

<p>UBP UNIVERSAL Pneumatic power clamp</p>  <p>Ø32 NEW</p>	<p>UBH UNIVERSAL Pneumatic power clamp</p> 	<p>IBP UNIVERSAL Pneumatic power clamp interchangeable with size 50/63 mm</p>  	
<p>UDP Pneumatic power clamp with 2 arms</p> 	<p>UBM/UBQ UNIVERSAL Pneumatic power clamp with hand lever</p> 	<p>IBM Pneumatic power clamp with hand lever interchangeable with size 50/63 mm</p> 	<p>UBT Pneumatic power clamp with central hand lever</p> 
<p>DMS Pneumatic power clamps conforming to the CNOMO Standard</p> 	<p>UGP/UGM Pneumatic gripper units (UGP) with hand lever (UGM)</p> 	<p>LGP Pneumatic gripper PATENT PENDING</p> <p>NEW</p>  	

AUTOMOTIVE POWER CLAMPS GRIPPER UNITS

UBS

Safety pneumatic power clamp



UNP

Pneumatic power clamps conforming to the N.A.A.M.S. Standard



UFL/UHL

Manual power clamps



UNM

Pneumatic power clamps with handlever conforming to the N.A.A.M.S. Standard



STEPLESS ADJUSTMENT

Opening angle adjustment $0 \div 135^\circ$

LIGHT-WEIGHT

Clamping arm and clamp housing in aluminium alloy

UNIVER ORIGINAL LINKAGE DESIGN

Ensures positional repeatability

UNIVER ORIGINAL METAL SENSOR

Metal case

M12 swivel connector



Pneumatic Power Clamp applications

RETRACTABLE LOCATING PIN UNITS

LCP

Pneumatic retractable locating pin units with single rod



LCG

Pneumatic retractable locating pin units with single rod



LCZ

Pneumatic retractable locating pin units with single rod and toggle-joint mechanism



LCM

Pneumatic retractable locating pin unit with hand lever



LCL

Manual retractable locating pin unit



LCO

Pneumatic retractable locating pin unit with double rod and hand lever



PNEUMATIC PIN CLAMPS

LSP

Pneumatic pin clamp



LSP50U

Pneumatic pin clamp - horizontal shape



LTP

Pneumatic pin clamp with vanishing hook



LUP

Pneumatic pin clamp with vanishing hook and pin



AUTOMOTIVE

PIN UNITS

PIN CLAMPS

LCA

Pneumatic retractable locating pin units with double rod



LCT

Pneumatic retractable locating pin units with double rod and toggle-joint mechanism



LCY

Pneumatic retractable locating pin unit with hand lever and toggle-joint mechanism



LCX

Pneumatic retractable locating pin unit with double rod and hand lever and toggle-joint mechanism



LSL

Manual pin clamp



Pneumatic Power Clamps and Pin Clamp applications

POWER PIVOTS

DMA

Pneumatic power pivots, CNOMO mounting



LAGP

Pneumatic power pivots



ELECTRIC UNITS

LAE

Electric power clamps



LNE

Electric power clamps, fixing conforming to the N.A.A.M.S. Standard



LGE

Electric gripper units

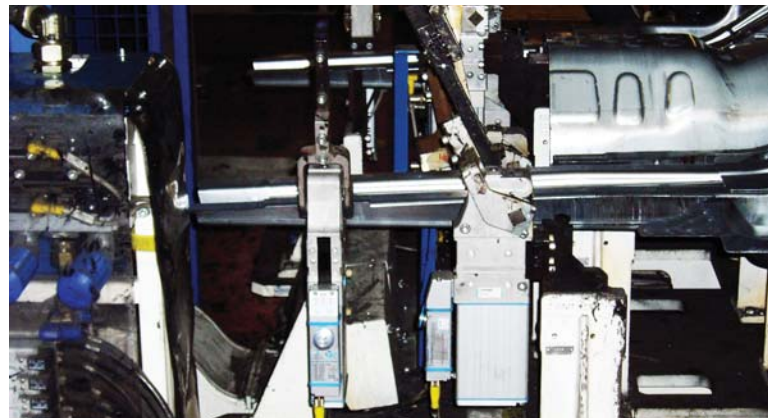

MARKING UNITS

PRP

Pneumatic marking unit



LCE

Electric retractable locating pin unit



LAGE

Electric power pivots

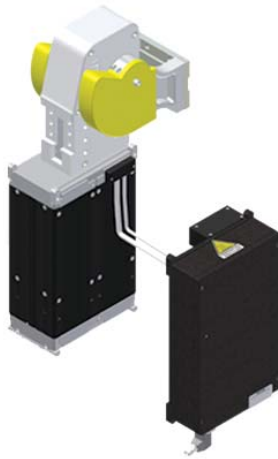

AUTOMOTIVE

POWER PIVOTS

MARKING UNITS

ELECTRIC UNITS

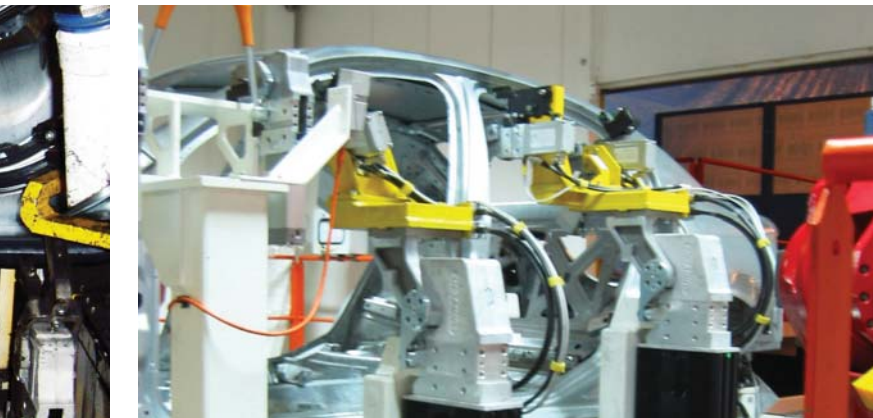

Pneumatic and electric Power Clamp applications

GR8 MODULAR TOOLING SYSTEM

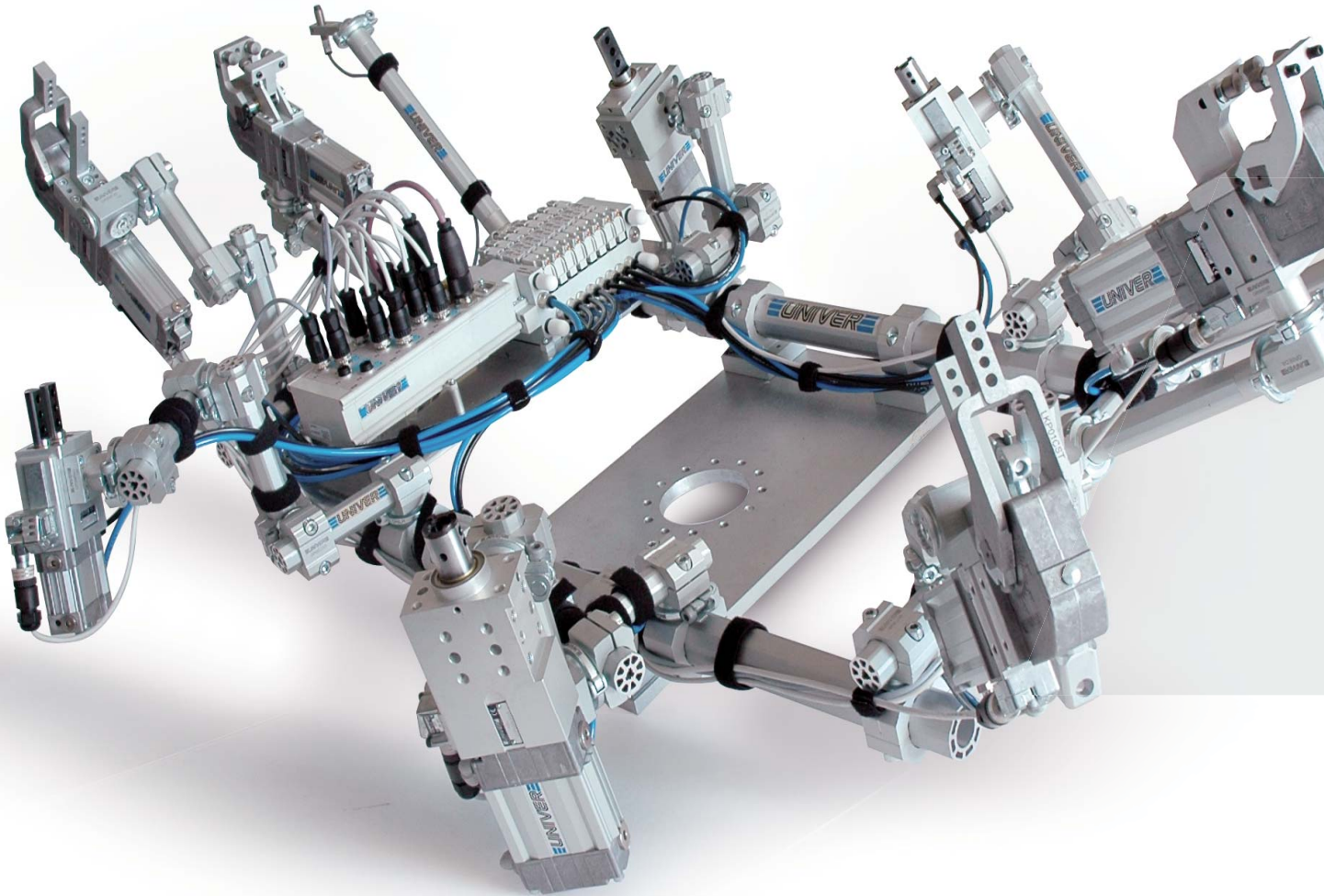

Ø 30 - 45 - 70 mm BOOMS

Maximum stiffness and minimum weight

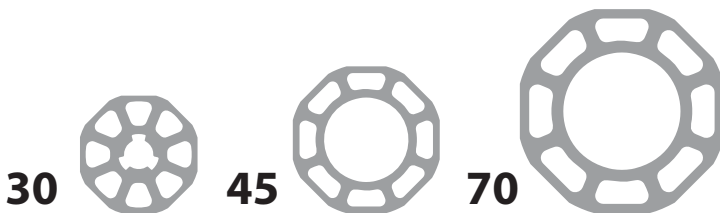

LOCKING RING

Precise and efficient system to guarantee a high level of positional accuracy

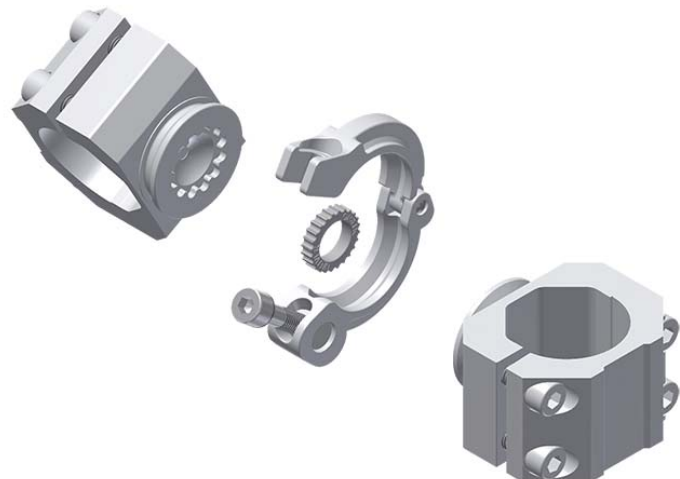

MODULAR TOOLING SYSTEM GR8 TOOLING

KIT

Considerable reduction
of mounting elements



HIGH PRECISION

High level of positional repeatability;
low deflection

MODULAR COMPONENTS

Considerable reduction of mounting components

QUICK INSTALLATION AND SET UP

No welding or douweling required,
easily replaceable components

FULLY ADJUSTABLE

Unlimited orientation in space and free
configurations

PATENT PENDING



BALL MOUNTING

Unlimited swivel rotation



GR8 MODULAR TOOLING SYSTEM

Applications and details of the components

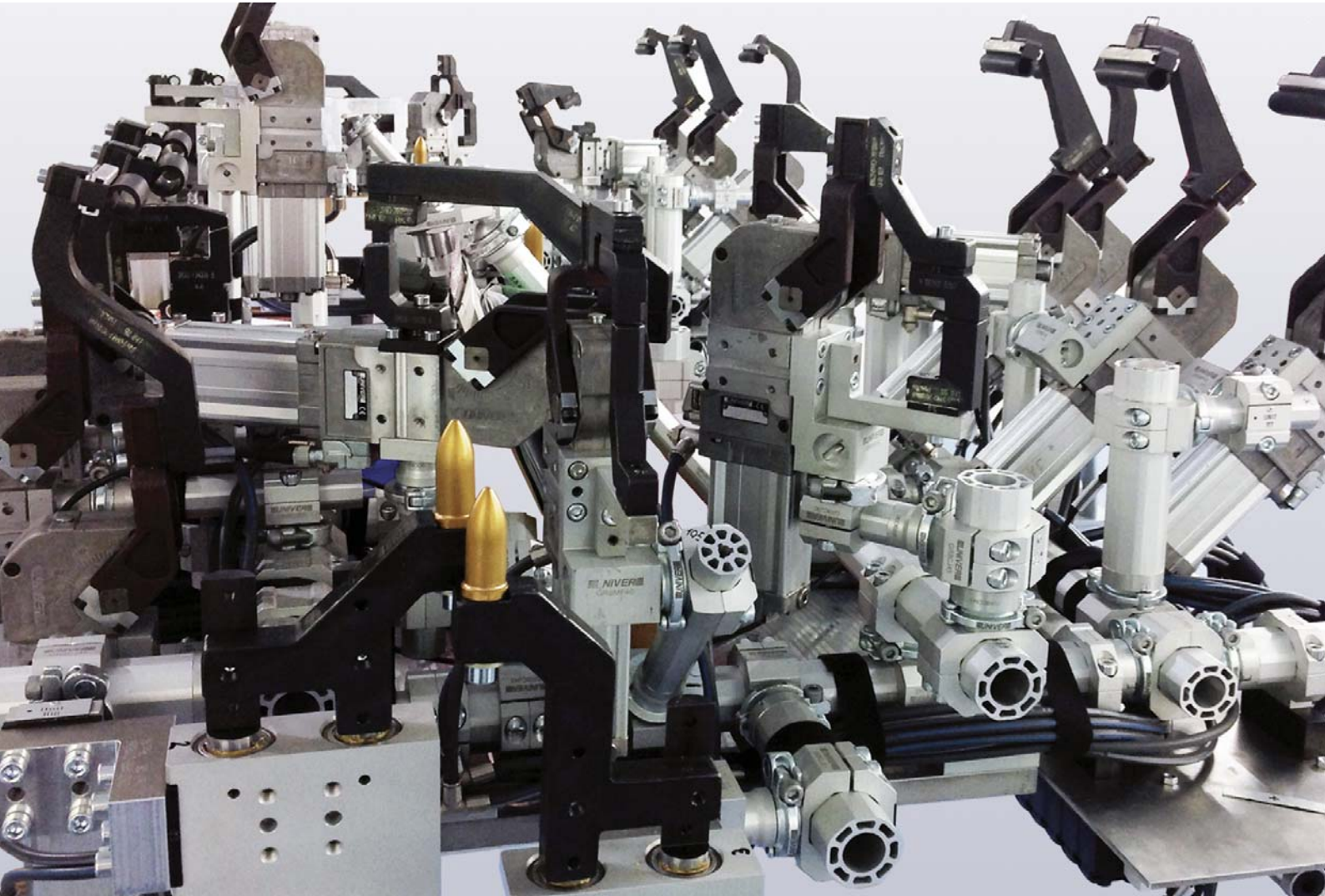

- Unlimited and complex configurations
- Weight-optimized standard components and brackets
- Quick installation and adjustment
- Modular components

MODULAR
TOOLING
SYSTEM
GR8 TOOLING

COMPLETE SOLUTION
WITH **UNIVER** COMPONENTS

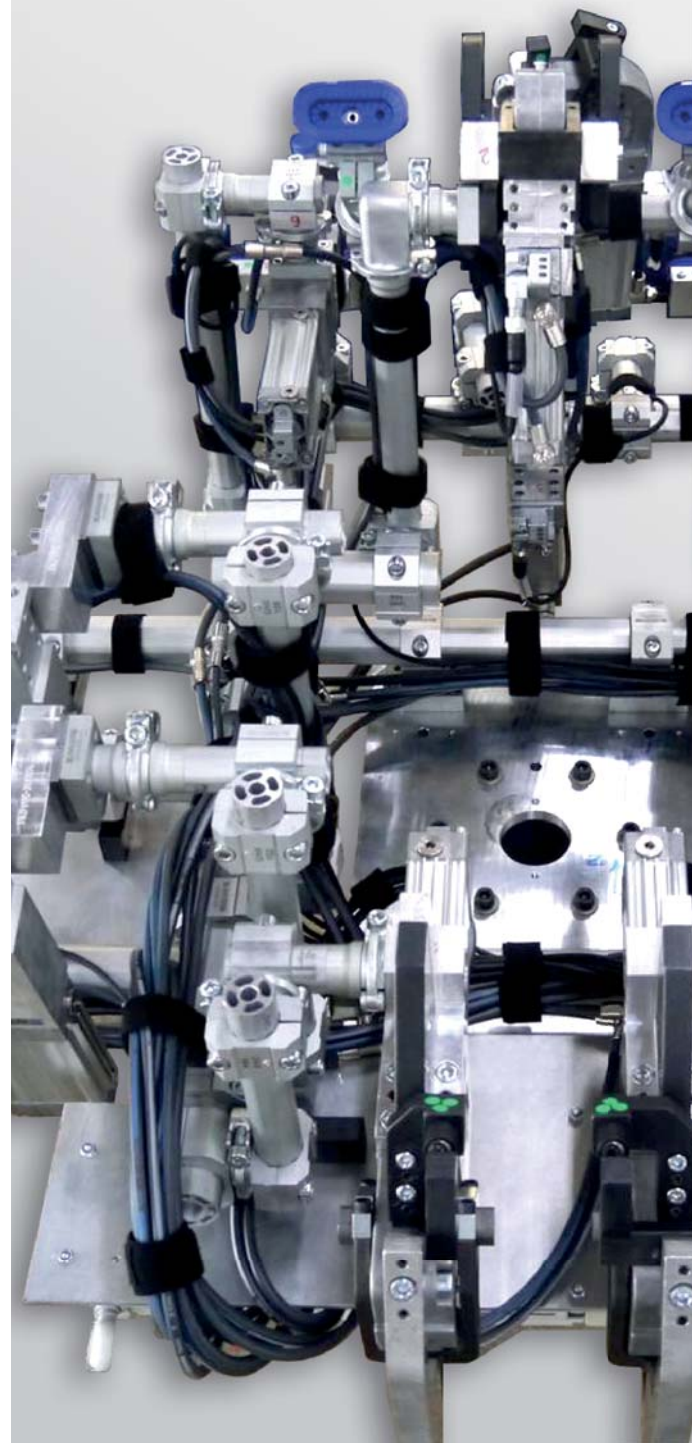
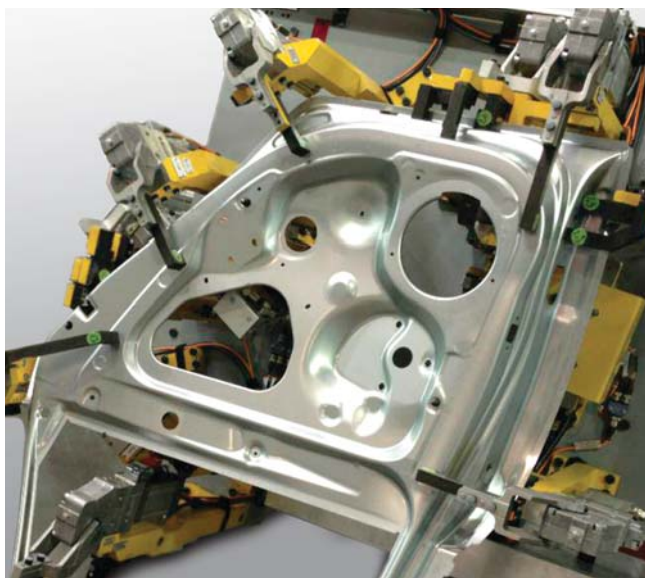
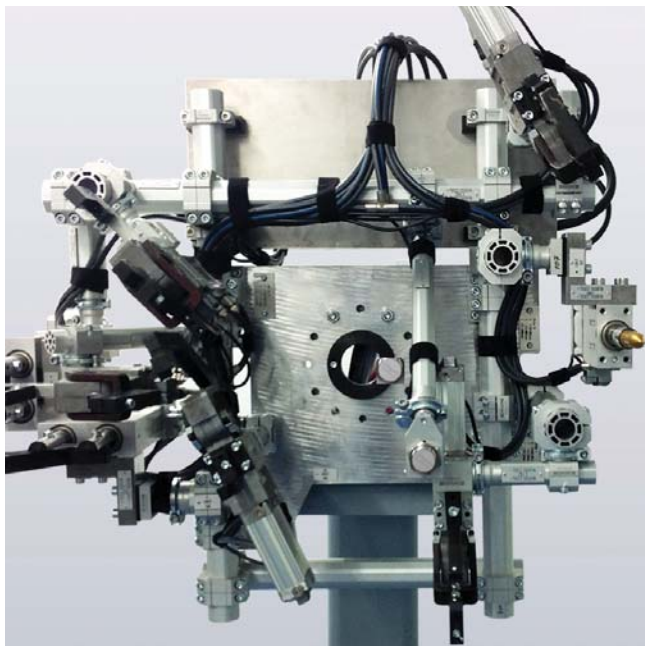
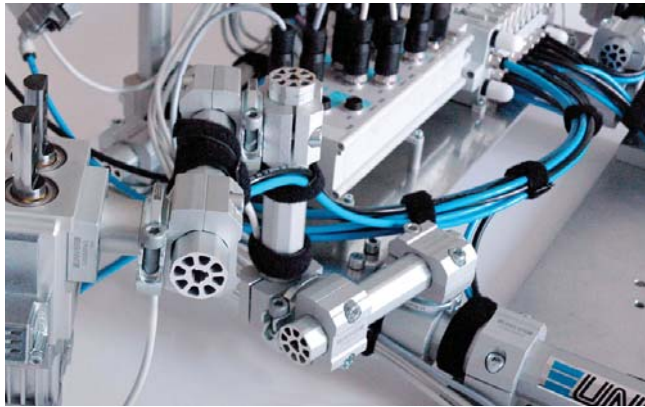



UNIVER S.p.A.

Headquarters

I - 20128 **Milano**
Via Eraclito, 31
Tel. +39 02 25298.1
Fax +39 02 2575254
info@univer-group.com
www.univer-group.com

UNIVER SERVICE S.r.l.

Headquarters

I - 20128 **Milano**
Via Empedocle, 20
Tel. +39 02 25298.1
Fax +39 02 25298370
universervice@universervice.it
www.universervice.it

Branch Offices

LOMBARDIA

I - 20128 **Milano**
Via Empedocle, 20
Tel. +39 02 25298.1
Fax +39 02 25298370
universervice@universervice.it

I - 24060 Castelli Calepio **Bergamo**

Via C. Curotti, 31/33
Tel. +39 030 7435420
Fax +39 030 733328
castellcalepio@universervice.it

I - 22040 Monguzzo **Como**

Via Valassina, 18
Tel. +39 031 617922
Fax +39 031 651222
monguzzo@universervice.it

PIEMONTE/LIGURIA/VALLE D'AOSTA

I - 10071 Borgaro Torinese **Torino**

Via Veneto, 18
Tel. +39 011 4501871
Fax +39 011 4502898
torino@universervice.it

VENETO/FRIULI VENEZIA-GIULIA TRENTINO-ALTO ADIGE

I - 30030 Vigonovo **Venezia**
Via Prima strada 16/A - Loc. Galta
Tel. +39 049 9834140
Fax +39 049 9833972
vigonovo@universervice.it

EMILIA ROMAGNA

I - 40069 Zola Predosa **Bologna**
Via Guido Rossa, 21
Tel. +39 051 753907
Fax +39 051 6184751
bologna@universervice.it

CENTRO/SUD

I - 40069 Zola Predosa **Bologna**
Via Guido Rossa, 21
Tel. +39 051 753907
Fax +39 051 6184751
bologna@universervice.it

UNIVER DO BRASIL S/A

BRAZIL - 13474-764
Americana **São Paulo** - SP
Rua do Polyester, 29
Distrito Industrial Abdo Najar
Tel. +55 19 3113-9400
Fax +55 19 3113-9405
atendimento@univer.com.br

UNIVER CHINA

CHINA - Shanghai
399 Fu Te North Road,
Free Zone, Pudong
info@univer-china.com

UNIVER FRANCE S.a.s.

FRANCE - 68000
Colmar
1, rue Denis Papin
Tel. +33 03 89210900
Fax +33 03 89216850
info@univer-france.fr

UNIVER G.m.b.H.

GERMANY - D-65428
Rüsselsheim
Eisenstraße 51
Tel. +49 6142 40832-0
Fax +49 6142 40832-90
info@univer-gmbh.de

UNIVER NORTH AMERICA

USA - 48312
Sterling Heights - **Michigan**
6620 Cobb Drive
Tel. +1 248 299 0525
Fax +1 248 299 0528
info@univer-group.us

UNIVER POLSKA Sp. z o.o.

POLAND - 25-663
Kielce
ul. K. Olszewskiego 21E
Tel. +48 41 278 72 53
Fax +48 41 278 72 54
univer@univer-group.pl

UNIVER S.L.

SPAIN - 08210
Barbera Del Valles **Barcelona**
Ronda Industria, 26 - 28
Tel. +34 93 7297360
Fax +34 93 7297380
univer@univerweb.com

Distributors worldwide:

Get in touch with UNIVER Sales Department
or visit our website www.univer-group.com



www.univer-group.com