

30

YEARS

AUTOMOTIVE DIVISION



Car Manufacturers which use our Clamps



A single supplier with a complete

Pneumatic Components
for **Automation**



Clamping
for **Autom**



product range for

**Technology
otive**

GR8
Modular Tooling System

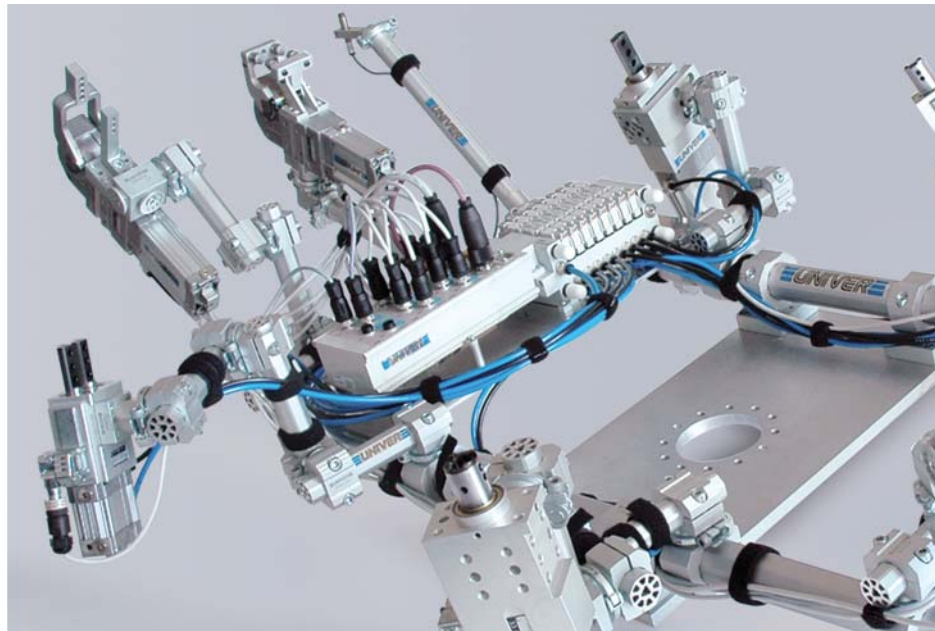



Our customers

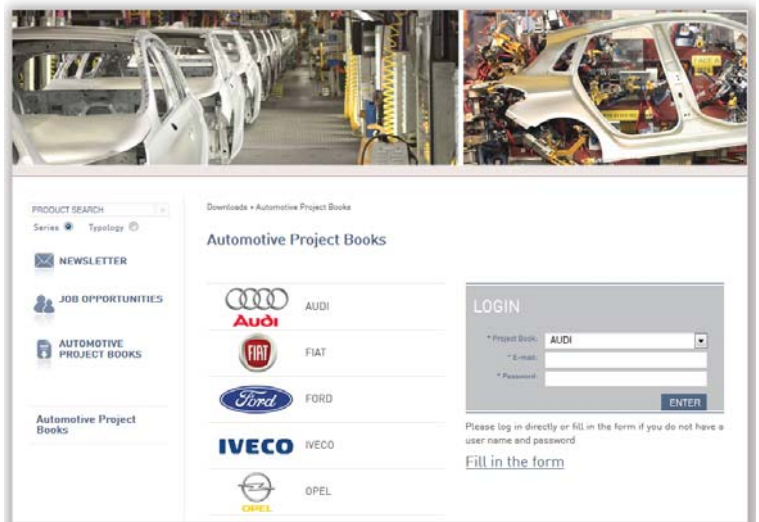

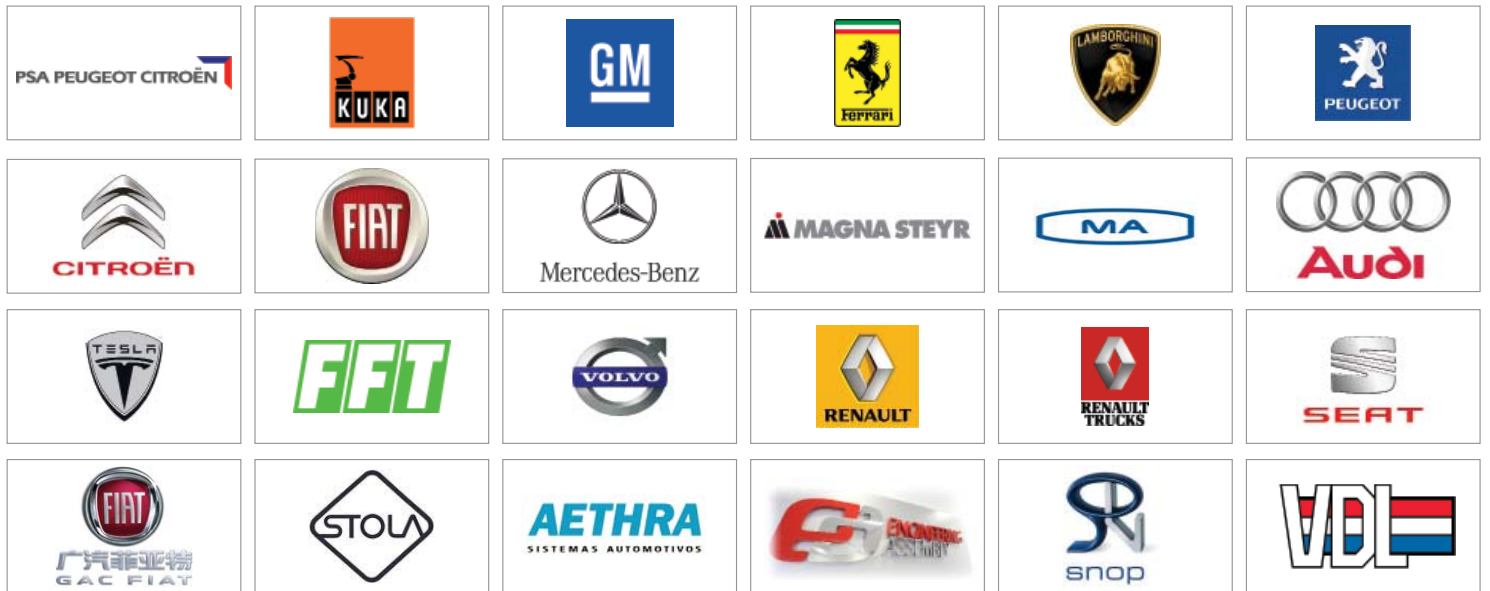

Online Project Books
www.univer-group.com



Complete range

Clamping Technology



Pneumatic Power

■ UBP

UNIVERSAL Pneumatic power clamp



■ UBH

UNIVERSAL Pneumatic power clamp



■ UBM

UNIVERSAL Pneumatic power clamp with handlever



■ IBM

Pneumatic power clamp with handlever interchangeable with sizes 50/63 mm



Clamps conforming to the **NAAMS/CNOMO** standard



■ UNP

Pneumatic power clamps conforming to the N.A.A.M.S. Standard



■ UNM

Pneumatic power clamps with handlever conforming to the N.A.A.M.S. Standard



■ DMS

Pneumatic power clamps conforming to the CNOMO Standard



Clamps

■ IBP

Pneumatic power clamp interchangeable with sizes 50/63 mm



■ UBS

Safety pneumatic power clamp



■ UDP

Pneumatic power clamp with 2 arms



■ UBQ

Pneumatic power clamp with handlever



■ UBT

Pneumatic power clamp with central handlever



■ UFL - UHL

Manual power clamps





Complete range

Pin Packages



■ LCX

Pneumatic retractable locating pin unit with two rods and handle lever and toggle-joint mechanism



Retractable locating single and double rod

■ LCP

Pneumatic retractable locating pin unit with single rod



■ LCG

Pneumatic retractable locating pin unit with single rod



Pneumatic retractable locating pin units with handlever



- **LCM**

Pneumatic retractable locating pin unit with handlever

- **LCL**

Manual retractable locating pin unit

- **LCO**

Pneumatic retractable locating pin unit with two rods and handlever

- **LCY**

Pneumatic retractable locating pin unit with handlever and toggle-joint mechanism



pin units

- **LCZ**

Pneumatic retractable locating pin unit with single rod and toggle-joint mechanism

- **LCJ**

Pneumatic retractable locating pin unit, with improved pull force

- **LCA**

Pneumatic retractable locating pin unit with double rod

- **LCT**

Pneumatic retractable locating pin unit with double rod and toggle-joint mechanism





Complete range

Pin Clamps

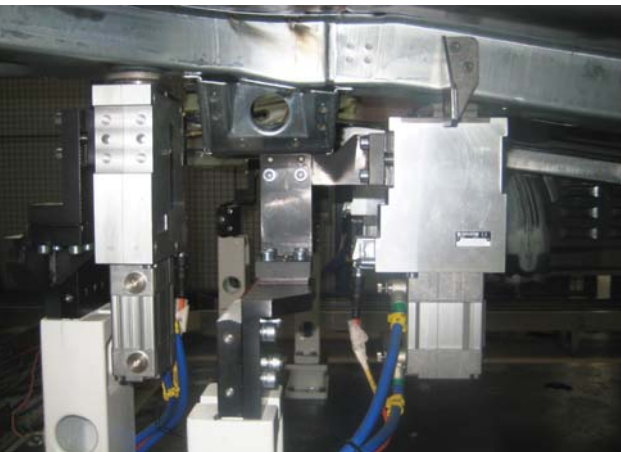

Pneumatic pin clamps

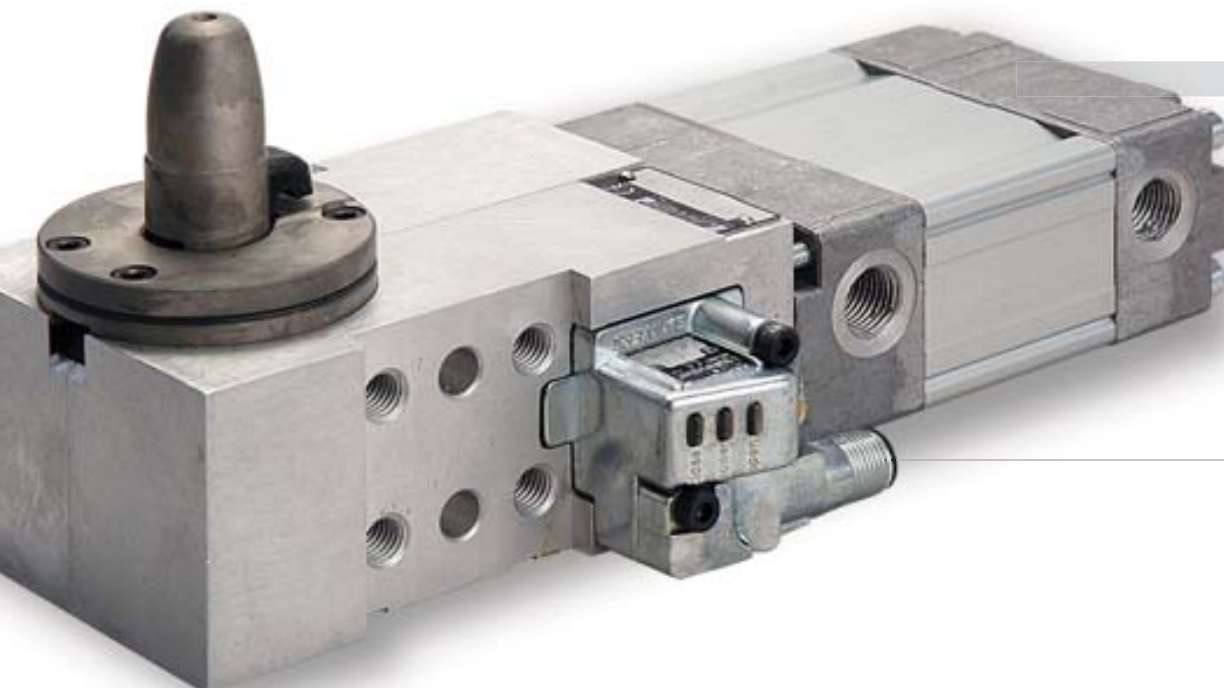

■ LSP

Pneumatic pin clamp



Gripper Units



■ UGP

Pneumatic gripper unit



■ UGM

Pneumatic gripper unit with handlever



■ LGP

Pneumatic gripper



NEW

PATENTS PENDING

■ LSP50U

Pneumatic pin clamp - horizontal shape



■ LTP

Pneumatic pin clamp with vanishing hook



■ LUP

Pneumatic pin clamp with vanishing hook and pin



■ LSL

Manual pin clamp





Complete range

Pivot Units



Power Pivots

LAGP

Pneumatic power pivots



LAGP063



LAGP075



LAGP080



LAGP120



LAGP150



Marking Units

■ PRP

Pneumatic marking unit



NEW



LAGP170



LAGP210



LAGP300



LAGP350



LAGP600-605



DMA200



Complete range

Electric Units

LAGE

Electric power pivots



Electric units

LAE

Electric power clamps

LNE

Electric power clamps, fixing conforming to the N.A.A.M.S. Standard

LGE

Electric gripper unit



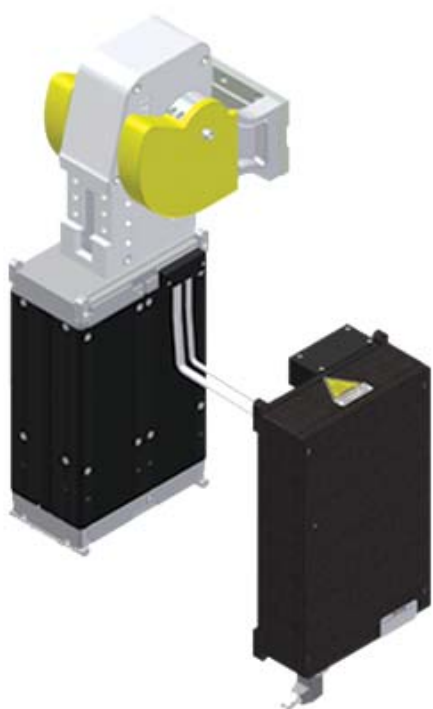

■ LCE

Electric retractable locating pin unit

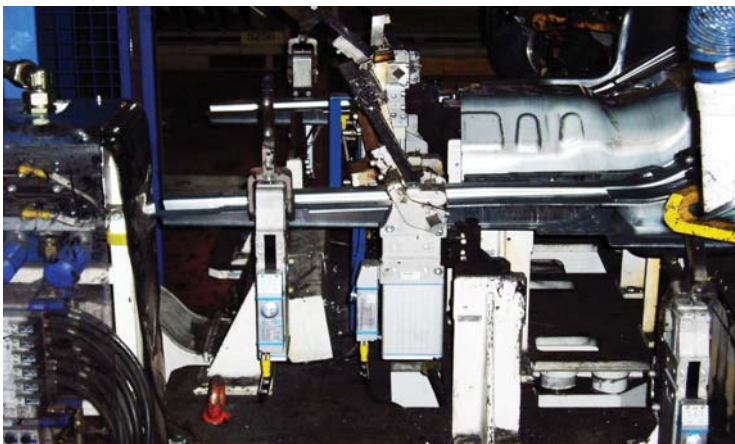



Complete range

Pneumatic Automation for Automotive

■ K

ISO 15552
Pneumatic Cylinders



■ KD

Ø 32 ÷ 125 mm ISO 15552
Pneumatic Cylinders
HEAVY SERIES TUBE



■ RM

Ø 16 ÷ 100 mm - ISO 21287
Compact Cylinders



■ JL

Guided Compact
Cylinders



Valves



■ BE

ISO 5599/1 Valves size 1-2-3-4



■ AC

Mixed Valves G1/8-G1/4-G1/2



Cylinders



R

Ø 32 ÷ 125 mm
Pneumatic Rotary Actuators



S1

Ø 16 ÷ 50 mm
Rodless Cylinders
Standard version



J

Slide Units
for pneumatic cylinders



RT

Ø 25 ÷ 63 mm
2/3 stage
Telescopic Pneumatic Cylinders



L1-N

Locking unit for
cylinders and piston rods



BE12

ISO 5599/1 Valves size 1-2-3-4



BD 18 mm

ISO 15407 -1/2 Valves



BD 26 mm

ISO 15407 -1/2 Valves



AG

Poppet Valves for vacuum
G1/8 ÷ G1 1/2



P15

15 mm COMPACT Valves



TC

Serial Communication Systems



CANopen

PROFINET

PROFIBUS

DeviceNet

EtherCAT

EtherNet/IP



Complete range

Pneumatic Automation for Automotive

Air Treatment

- HZE-Y Gradual starter
- HZE-N Diverter block
- HZE-P Lockable valve
- HZE-S Shutt-off valve
- HZE-RL Lockable regulator



- HB Nickel-plated Brass Push-in Fittings
- HA Technopolymer Push-in Fittings



HZE

Size 0 - 1 - 2

G1/4 ÷ G3/4

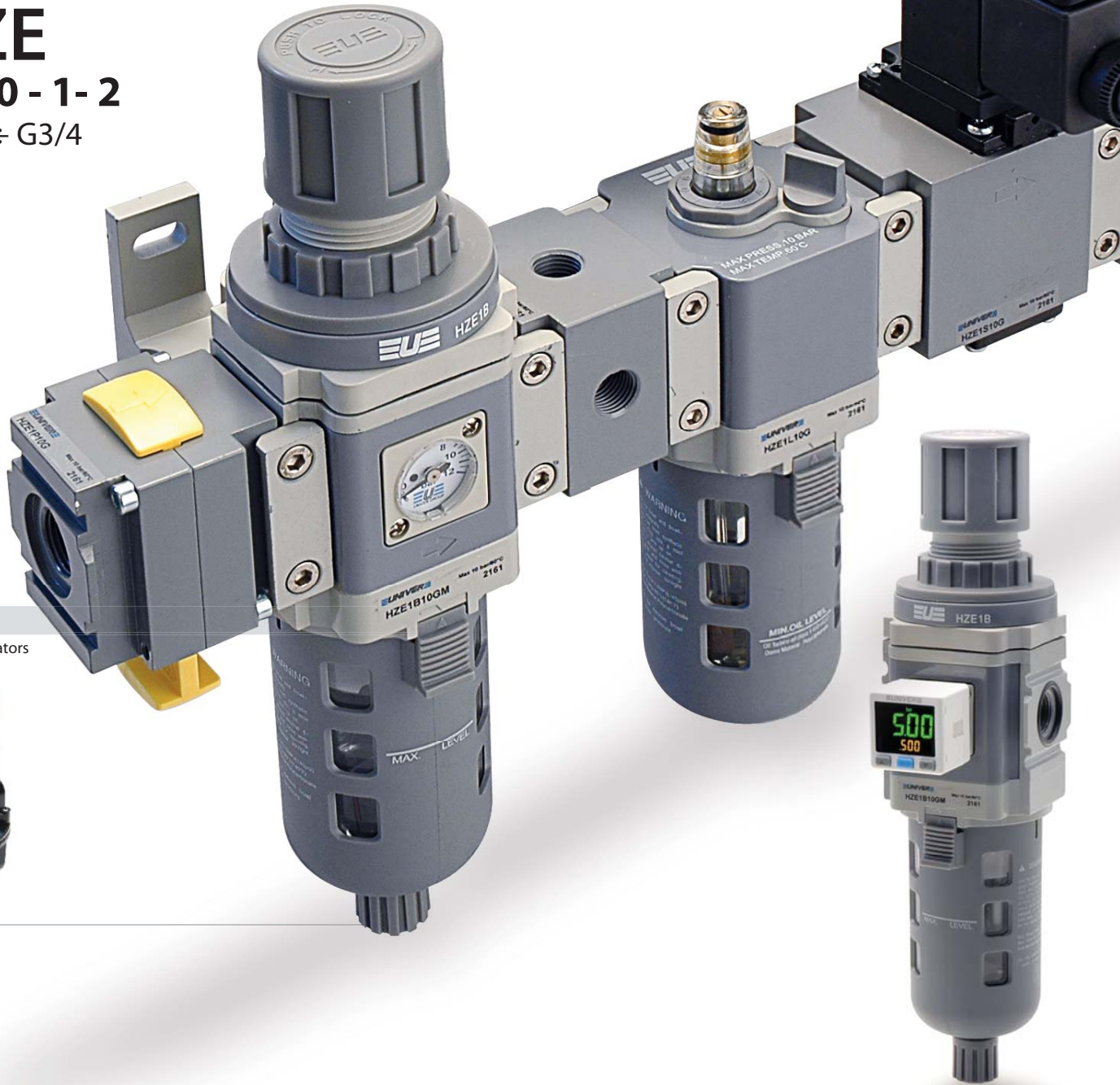

■ HZRP20
Precision regulators



Accessories

■ HGU

Quick Couplings for Compressed Air



■ HC

Fittings and Accessories with pneumatic functions



■ AM-55

Blocking valve



■ AM-53

Economizer G1/8 ÷ G1





GR8

Modular Tooling System

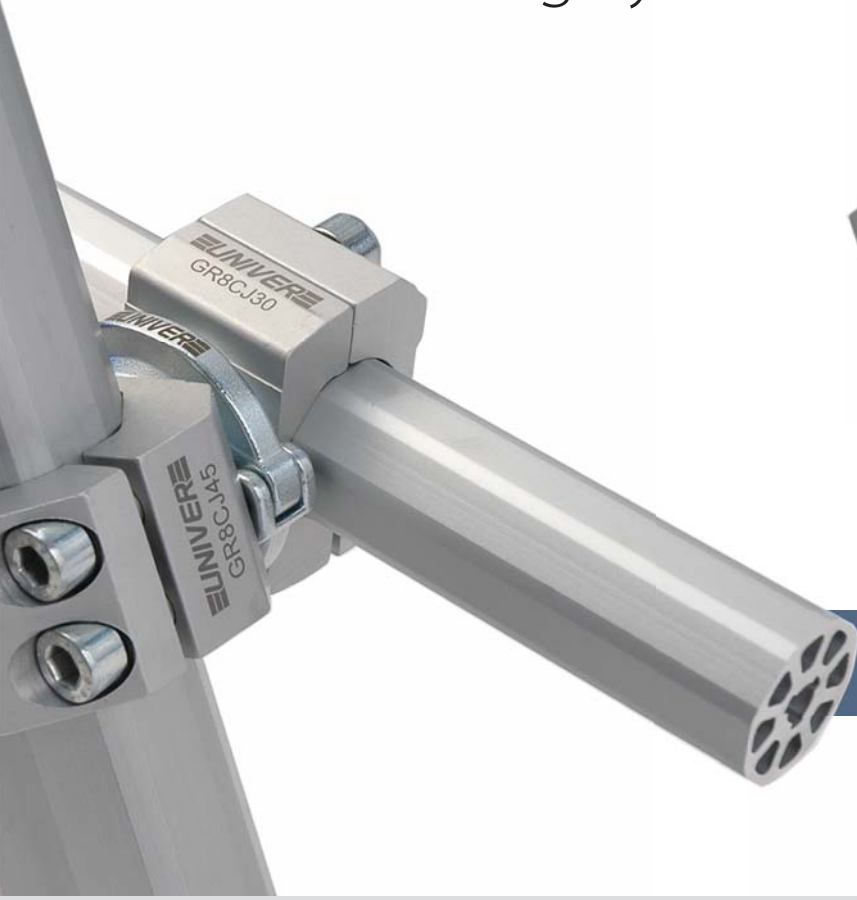

KIT

Considerable **reduction**

Ø 30 - 45 - 70 mm booms

Maximum stiffness and minimum weight

**PATENT
PENDING**

30



45



70



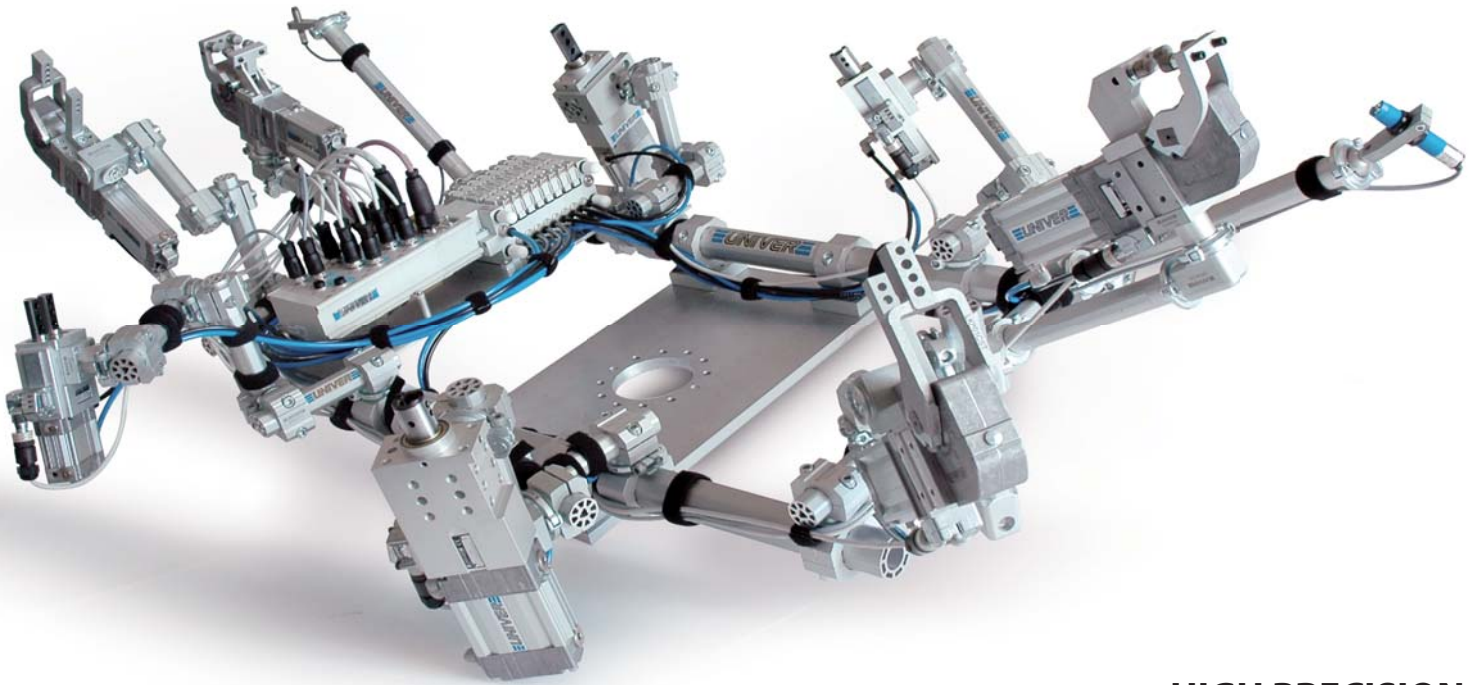

HIGH PRECISION

High level of positional repeatability; low deflection

MODULAR COMPONENTS

Considerable reduction of mounting components

QUICK INSTALLATION AND SET UP

No welding or doweling required,
easily replaceable components

FULLY ADJUSTABLE

Unlimited orientation in space and free configuration

of mounting elements

Locking ring

Precise and efficient system to guarantee a high level of positional accuracy

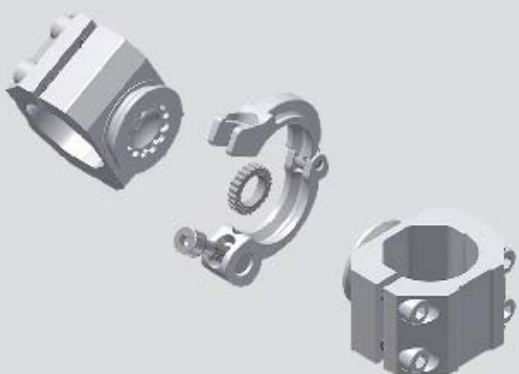

Ball mounting

Unlimited swivel rotation





GR8

End Effectors

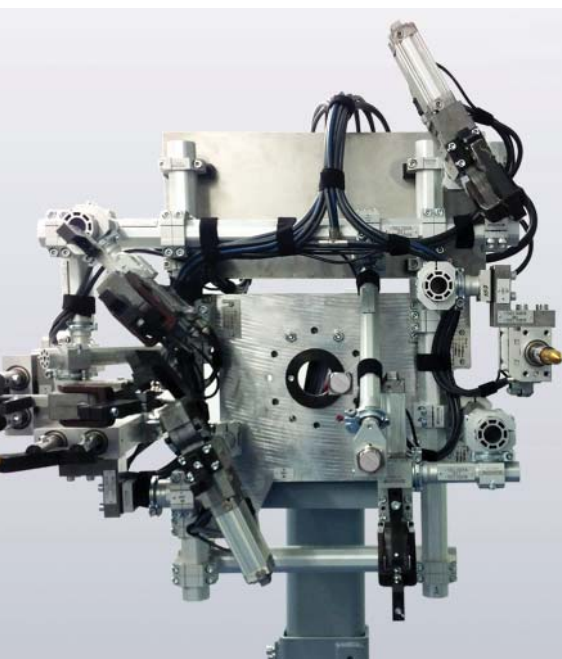

Unlimited and complex configurations
Weight-optimized standard components and brackets
Quick installation and adjustment

Applications and details

Complete Solution with UNIVER Components

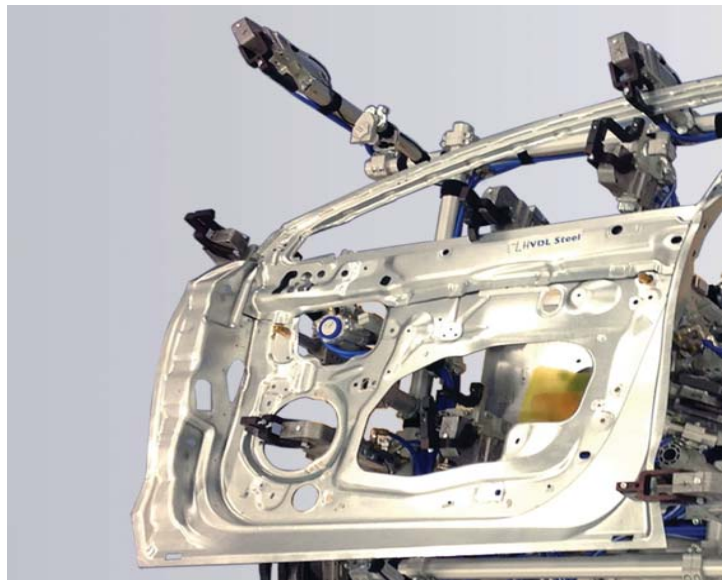
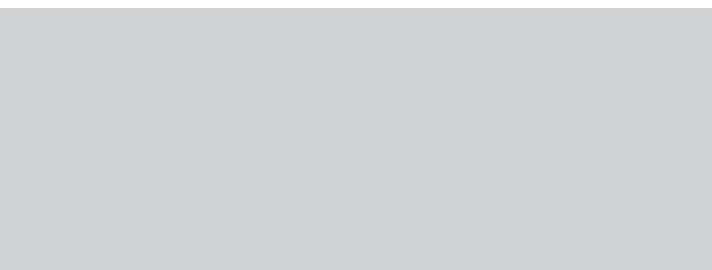
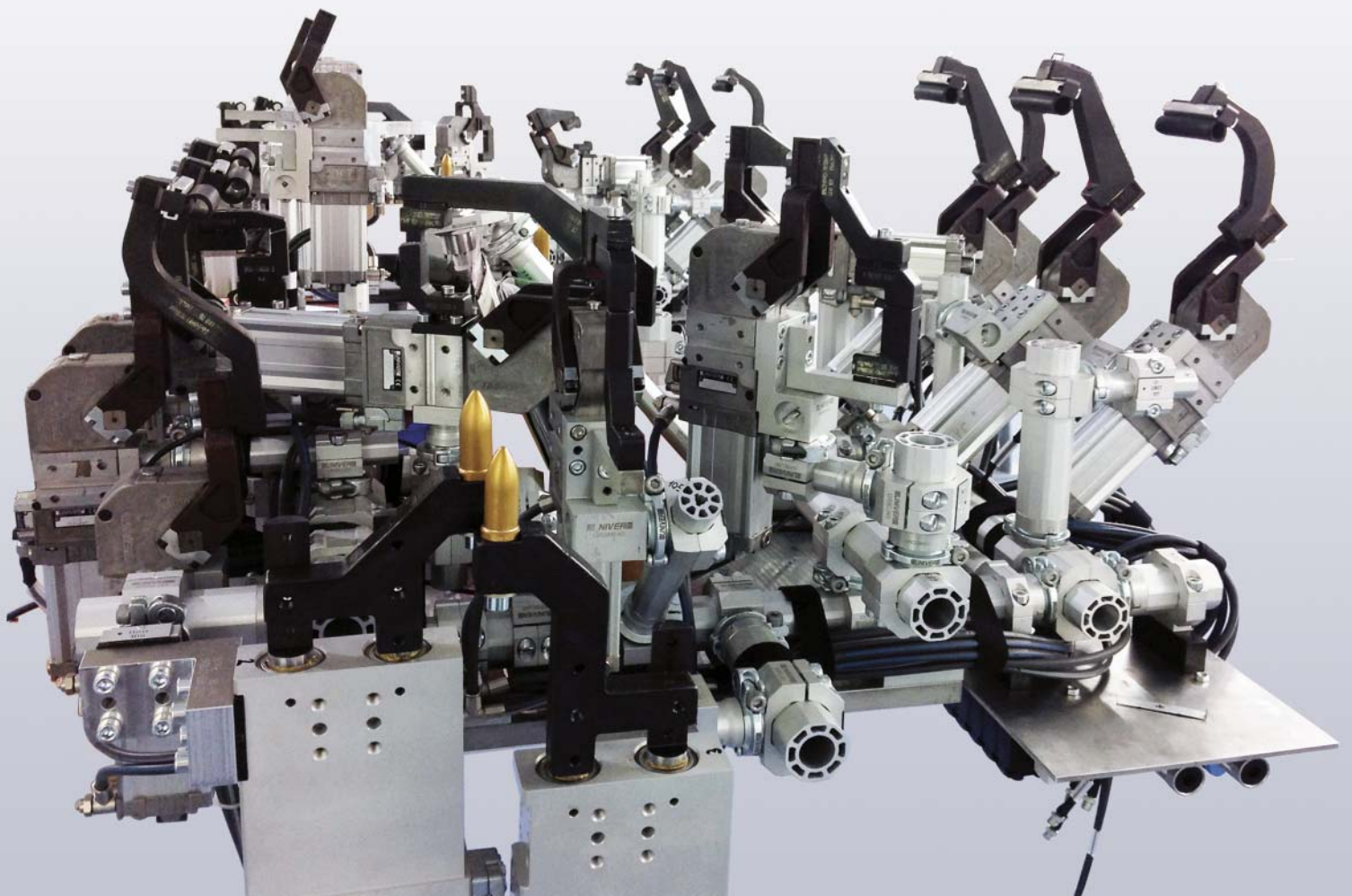



UNIVER S.p.A.

Headquarters

I - 20128 **Milano**
Via Eraclito, 31
Tel. +39 02 25298.1
Fax +39 02 2575254
info@univer-group.com
www.univer-group.com

UNIVER SERVICE S.r.l.

Headquarters

I - 20128 **Milano**
Via Empedocle, 20
Tel. +39 02 25298.1
Fax +39 02 25298370
universervice@universervice.it
www.universervice.it

Branch Offices:

Milano
Bergamo
Como
Torino
Venezia
Bologna

UNIVER do Brasil S/A

BRASIL - 13474-764
Americana **São Paulo - SP**
Rua do Polyester, 29
univerbrasil@univer.com.br

UNIVER CHINA

CHINA - 399 Fu Te North Road,
Free Zone Pudong, **Shanghai**
info@univer-china.com

UNIVER FRANCE S.a.s.

FRANCE - 68000
Colmar
1, rue Denis Papin
info@univer-france.fr

UNIVER G.m.b.H.

GERMANY - D-65428
Rüsselsheim
Eisenstraße 51
info@univer-gmbh.de

UNIVER NORTH AMERICA

USA - 48312
Sterling Heights, Michigan
6620 Cobb Drive
info@univer-group.us

UNIVER Polska Sp. z o.o.

POLAND - 25-663
Kielce
ul. K. Olszewskiego 21E
univer@univer-group.pl

UNIVER S.L.

SPAIN - 08210
Barbera Del Valles **Barcelona**
Ronda Industria, 26 - 28
univer@univerweb.com



www.univer-group.com

Distributors worldwide:

Get in touch with UNIVER Sales Department or visit our website www.univer-group.com