

Binary Counter (Flip Flop)

■ AP-500

Electrical override

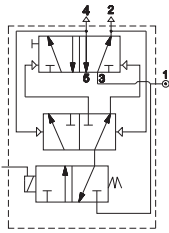

Working pressure: 10 bar
Energizing pressure: 1,5 bar
Ambient temperature: -30 ÷ +80 °C
Coil: U1 - DA series

■ AP-520

Pneumatic override

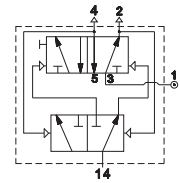

Solenoid valves are supplied without coil/connector/locking nut

Flow control valve - metallic body

■ AM-50

One-way and two-way flow control valve
M5 - G1/8 - G1/4 - G3/8 - G1/2

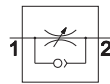

One-way regulation

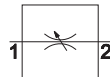

Two-way regulation

		Ø mm
AM-5060	M5	1
AM-5061	G1/8	1
AM-5062	G1/8	2,25
AM-5063	G1/8	3,5
AM-5064	G1/4	5
AM-5065	G1/4	6
AM-5066	G3/8	6
AM-5067	G1/2	9
AM-5070	M5	1
AM-5071	G1/8	1
AM-5072	G1/8	2,25
AM-5074	G1/4	5
AM-5076	G3/8	6
AM-5077	G1/2	9

■ AM-50

One-way flow control valve G1/2 - G3/4 - G1

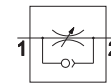

One-way regulation

		Ø mm
AM-5090	G1/2	9
AM-5091	G3/4	9
AM-5092	G1	12

Signal processing valve

■ AM-51

Two-pressure valve "AND"

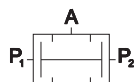

AM-5160
threaded body G1/8

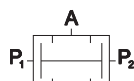

AM-5161
push-in fittings Ø4x2

■ AM-51

Selector valve "OR"

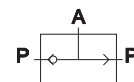

AM-5162
threaded body G1/8

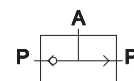

AM-5163
push-in fittings Ø4x2

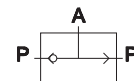

AM-5164
threaded body G1/4

Gradual starter

AM-52
Gradual starter G1/8 ÷ G1



With manual regulation

Model	Connection	Ø mm
AM-5240	G1/8	6,5
AM-5241	G1/4	6,5
AM-5242	G1/4	9,5
AM-5243	G3/8	9,5

With electrical switch

Model	Connection	Ø mm
AM-5242E	G1/8	9,5
AM-5243E	G3/8	9,5



With manual regulation

Model	Connection	Ø mm
AM-5254	G1/2	15
AM-5255	G3/4	15
AM-5256	G 1	24

With electrical switch

Model	Connection	Ø mm
AM-5259	G1/2	15
AM-5260	G3/4	15
AM-5261	G 1	24

Economizer

AM-53
Economizer G1/8 ÷ G1



Model	Connection	Ø mm
AM-5350	G1/8	6,5
AM-5351	G1/4	6,5
AM-5352	G1/4	9,5
AM-5353	G3/8	9,5
AM-5354	G1/2	15
AM-5355	G3/4	15
AM-5356	G 1	24

Check valve

AM-54
Check valve G1/2 - G3/4 - G1



Model	Connection	Ø mm
AM-5400	G1/2	15
AM-5401	G3/4	15
AM-5402	G 1	24

Blocking valve

AM-55
Blocking valve



One-way

Model	Connection	Ø mm
AM-5500	G1/8	6,5
AM-5501	G1/4	6,5
AM-5502	G1/4	9,5
AM-5503	G3/8	9,5
AM-5504	G1/2	15

Two-way

Model	Connection	Ø mm
AM-5510	G1/8	6,5
AM-5511	G1/4	6,5
AM-5512	G1/4	9,5
AM-5513	G3/8	9,5
AM-5514	G1/2	15

Transducer and pressure switch

AM-5200
Pneumo-electrical transducer



AM-5200

AM-5220
Adjustable pressure switch



AM-5220