

PNEUMATIC AUTOMATION

CILINDROS
HIGH-TECH
VÁLVULAS
TRATAMENTO DE AR
ACESSÓRIOS



AUTOMOTIVE

GRAMPO
PINOS LOCALIZADOR
GRAMPOS LOCALIZADORES
PINÇAS
UNIDADES GIRATÓRIAS
UNIDADES DE MARCAÇÃO
GRAMPOS ELÉTRICOS



MODULAR TOOLING SYSTEM

GARRAS GR8

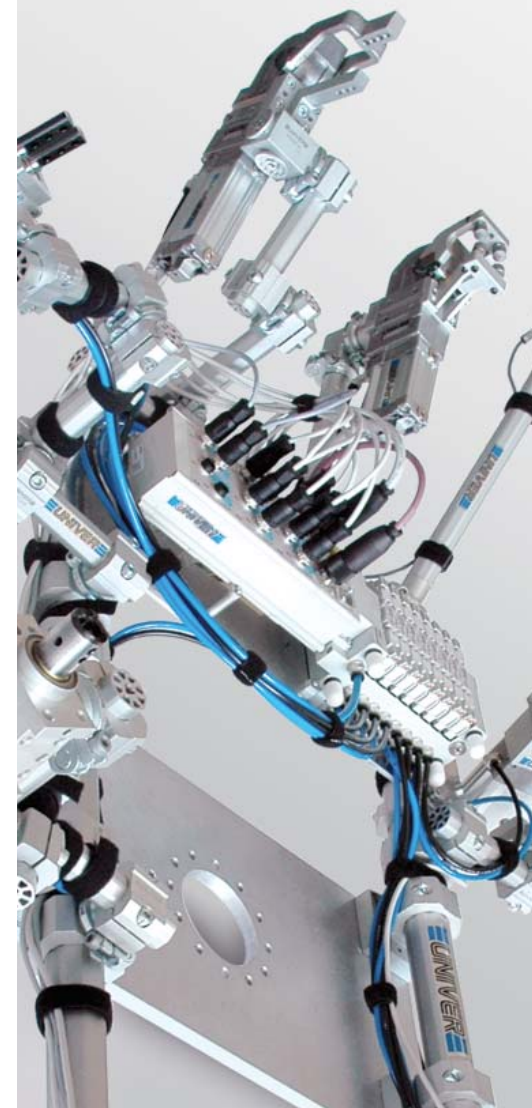



As Origens



Pneumática



Automotive



Garras GR8

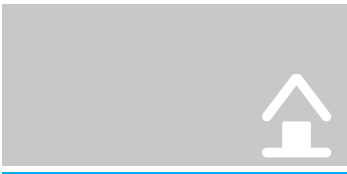

UNIVER inicia a própria atividade no campo da automação industrial nos anos 70, com a produção da primeira série de válvulas de ar comprimido e vácuo com obturador.



Nas décadas sucessivas a gama de produtos se complementa com componentes pneumáticos tecnologicamente avançados e originais UNIVER, consentindo um progressivo crescimento e desenvolvimento da empresa, ao ponto de se tornar uma das maiores sociedades italianas na produção de componentes no mercado da automação.



Em 2000, graças a plurianual experiência no fornecimento de produtos da Divisão Pneumatic Automation no mercado automotivo, nasce a Divisão Automotive, especializada em soluções para BIW da indústria automobilística.



O mais recente lançamento é a divisão Modular Tooling System (GR8) que representa um novo desafio dentro da movimentação das chapas de aço e aplicações BIW no setor automotivo e industrial.

Alguns dos nossos clientes

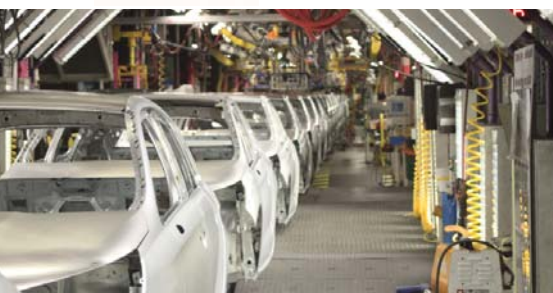

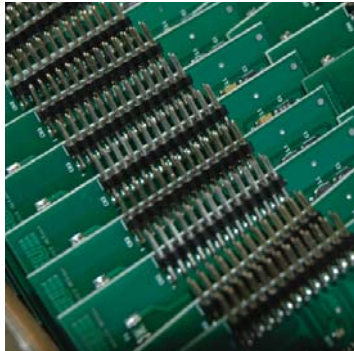

Eletrônica



A divisão eletrônica, em suporte das divisões Pneumatic Automation e Automotive, é especializada no estudo, projeto e realização dos dispositivos elétricos e eletrônicos integrados nos produtos **UNIVER**.



Univer Service



Na Itália a sociedade comercial **UNIVER SERVICE S.r.l.** controla o mercado nacional e garante um serviço rápido e eficaz com a colaboração de unidades operativas diretas e de diversos distribuidores em todo o território.



Univer Group



O grupo **UNIVER** está presente mundialmente em diversas filiais e como rede de distribuição ativa em todas as áreas mais industrializadas do mundo.



Inovação
Pesquisa e desenvolvimento
Qualidade
Formação
Comunicação

www.univer-group.com



CILINDROS PADRÃO NORMALIZADOS

M

Cilindros pneumáticos ISO 6432
ISO 6432 Ø8 ÷ 25 mm



KL

Cilindros pneumáticos ISO 15552
Ø32 ÷ 125 mm
CLEAN PROFILE



KE/K

Cilindros pneumáticos ISO 15552
Ø32 ÷ 125 mm



CILINDROS COMPACTOS NORMALIZADOS

RP/RM

Cilindros compactos UNITOP (RP Ø16 ÷ 63 mm),
ISO 21287 (RM Ø16 ÷ 100 mm)



RO/RN

Cilindros compactos UNITOP (RO Ø16 ÷ 63 mm),
ISO 21287 (RN Ø16 ÷ 63 mm) - Tubo octogonal
ANTI-ROTAÇÃO



CILINDROS OVAIS/CURSO BREVE/ ROTATIVOS

OV

Cilindros ovais
Ø18 ÷ 80 mm



W

Cilindros curso breve
Ø12 ÷ 100 mm
TUBO NOVO DESIGN



R

Cilindros pneumáticos rotativos
Ø32 ÷ 125 mm



PNEUMATIC AUTOMATION

CILINDROS

KD

Cilindros pneumáticos ISO 15552
Ø32 ÷ 125 mm
TUBO SÉRIE PESADO



K

Cilindros pneumáticos ISO 15552
Ø160/200 - 250/320 mm



KL

CLEAN PROFILE

Limpeza fácil

INSTALAÇÃO RÁPIDA

Sensores e coleamentos em um lado

TECNOLOGIA UNIVER

Robustez e confiabilidade

ISO 15552

Permutabilidade

RS

Cilindros compactos STRONG
Ø32 ÷ 100 mm



RQ

Cilindros compactos STRONG
Ø32 ÷ 100 mm - Tubo octogonal
ANTI-ROTAÇÃO



SENSOR

MP

Cilindro retorno mola



DF/DH

Sensores magnéticos
e eletrônicos de proximidade



CILINDROS SEM HASTE

S1

Cilindros sem haste versão padrão
Ø16 ÷ 50 mm



S5

Cilindros sem haste com guias integradas
Ø 25 ÷ 50 mm - Patim em tecnopolímero

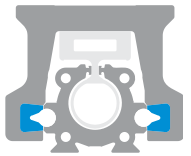

CILINDROS GUIADOS

J1

Unidade de guia para cilindros
série M, KE/K, KD



J3

Unidade de guia para cilindros sem haste
série S1

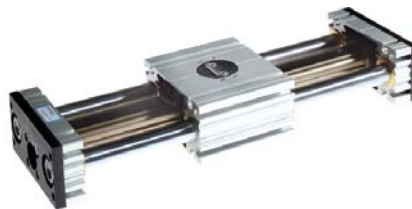

J64RS

Unidade de guia para cilindros compactos
STRONG série RS



J65

Unidade de guia para cilindros compactos
série RP Ø25



JLS/JLV

Cilindros guiados
Bucha deslizante (JLS) - Bucha de esferas (JLV)



Versão com
bucha limpa-haste
metálico (a pedido)



**KIT DE MONTAGEM
CILINDROS**



M/KE/K/KD



RP/RM-RO/RN

PNEUMATIC AUTOMATION

CILINDROS

VL1

Versão com guias integradas a 90°
Ø 25 ÷ 50 mm - Deslizamento com rolamentos de esferas

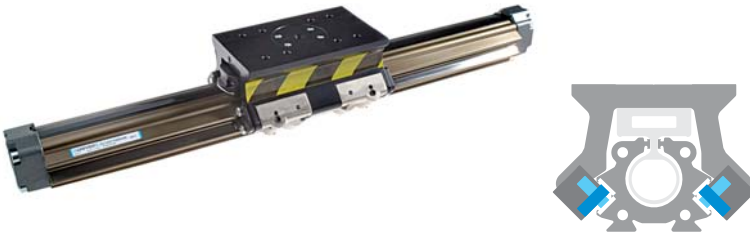

S1/S5/VL1

Original UNIVER desde 1988

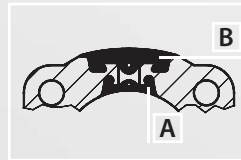

A- Faixa interna (sigilo)
B- Faixa externa (proteção)
em elastômero reforçado com
inserção em Kevlar

J64RT2

Unidade de guia para cilindros telescópicos
série RT2



JT/JX

Guias lineares



UNIDADE DE BLOQUEIO

L1-N

Unidade de bloqueio para cilindros e hastes



ORIGINALE

Sistema de bloqueio original UNIVER desde 1998

ESTÁTICO/DINÂMICO

Bloqueio estático e frenagem dinâmica em um único dispositivo

POTENTE

A força de bloqueio mais elevada entre os dispositivos equivalentes presentes no mercado

SEGURO

Nenhum deslizamento da haste mesmo em presença de óleo ou graxa

L6

Unidade de bloqueio para cilindros sem haste série S5 - VL1



ATUADORES PNEUMÁTICOS INTELIGENTES

NTZ

Atuador pneumático com detector de cota e sistema de bloqueio de segurança integrado



NQZ

Atuador pneumático com detector de cota



PINÇAS PNEUMÁTICAS

YMA10/YMP10

Pinça pneumática abertura angular e paralela padrão



YMA20

Pinça pneumática abertura angular 180°



YMP20

Pinça pneumática abertura paralela guiada



YMP30

Pinça pneumática abertura paralela compacta



CILINDROS TELESCÓPICOS

RT

Cilindros telescópicos
2 estágios (RT2 Ø25 ÷ 63 mm) 3 estágios (RT3 Ø40 ÷ 63 mm)



Cilindros telescópicos
2 estágios

NFZ

Atuador pneumático com sistema de bloqueio de segurança integrado



YMP40

Pinça pneumática maior
abertura paralela



YMP50

Pinça pneumática autocentragem
3 pontos



PNEUMATIC AUTOMATION

HIGH-TECH

RT

ORIGINAL

Design e tecnologia original UNIVER

INDUSTRIALIZADO

Componentes industrializados com produtos e tecnologias de ponta

DIMENSÃO REDUZIDA

-60% menor do que cilindros padrão

ANTI-ROTAÇÃO

Padrão de série com tubo octogonal anti-rotação

Cilindros telescópicos

3 estágios



ELETROPILOTOS

B11- B10 - B12

Nanoválvulas ISO 15218 - 10 mm
 B11 Padrão
 B10 Baixo consumo
 B12 Alto fluxo



B

Nanoválvulas 10 mm



A

Microválvulas ISO 15218 - 15 mm

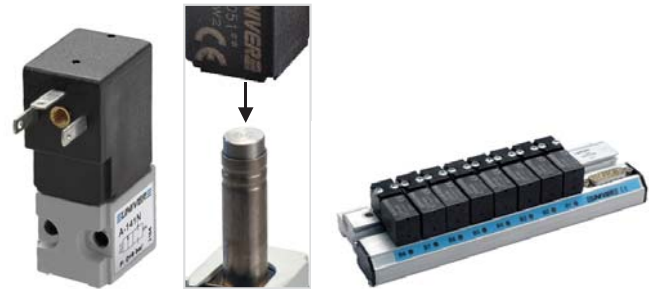

VÁLVULAS NORMALIZADAS

BE/BE12

Válvulas ISO 5599/1 - Sistema misto e spola

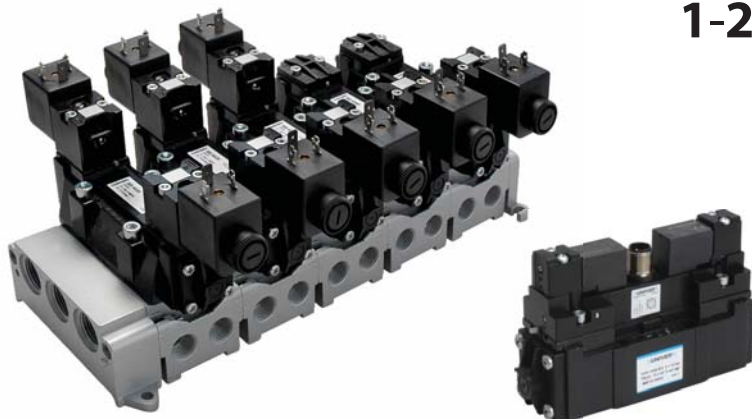

M12

Tamanhos
1-2-3-4

SISTEMA MISTO e SPOOL

Disponível todos os tipos em versões com sistema misto ou spool



MISTO
 para aplicações pesadas



SPOOL
 para todas as aplicações

AC-N

Distribuidores NAMUR



BD

Distribuidores ISO 15407-1/2

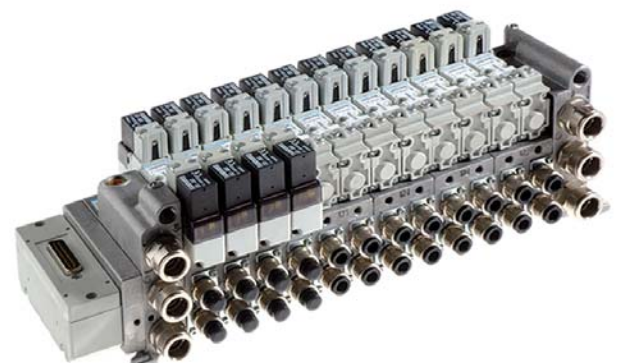

AA

Eletropilotos miniaturizados U1



AB

Eletropilotos miniaturizados U2



AE

Distribuidores série leve ISO 5599/1

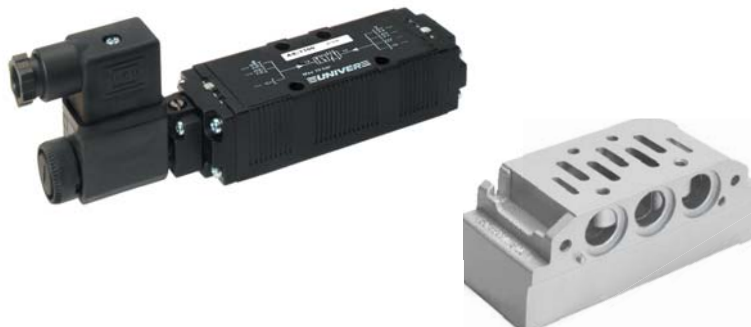

Tamanhos
1-2

ISO
01-02



18 mm (ISO 02)



26 mm (ISO 01)

PNEUMATIC AUTOMATION VÁLVULAS

Placa base com
conexão elétrica
integrada



Memória magnética
BIESTÁVEL



Distribuidores ISO 15407-1/2

BDE

Conexão elétrica integrada
(ISO 15407/2)

BDB

Conector M12
(Automotive)

BDA

Conexão elétrica
única e pneumática
(ISO 15407/1)

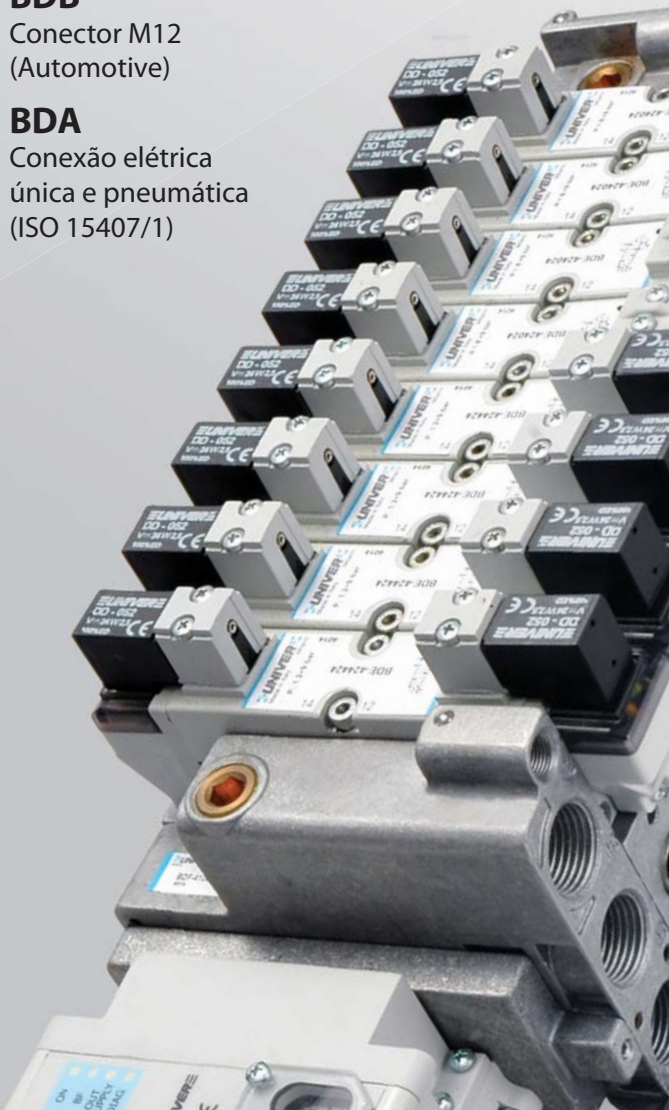

VÁLVULAS SPOOL

CL/CM

Distribuidores UNIVERSAL G1/8 - G1/4



E/F

Distribuidores miniaturizados
COMPA 2 (série E) COMPA 4 (série F)



G7

Distribuidores e eletrodistribuidores
26 mm - G1/8



G6

Distribuidores e eletrodistribuidores 20 mm
Corpo rosqueado G1/8

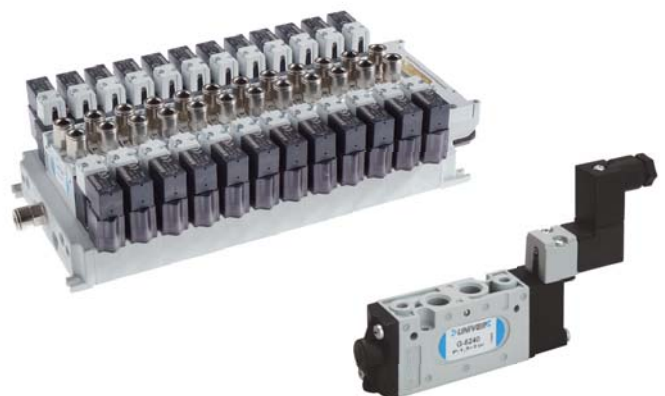

VÁLVULAS COM OBTURADOR

AF/AG

Válvulas com obturadores para ar comprimido (AF) e para vácuo (AG)
G1/8 ÷ G1 1/2



CH

Válvulas com obturador G1/8 2/2 - 3/2



AI/AI-JET

Interruptores de fim de curso miniaturizados (AI)
Base mecânica para acionamento no painel - mola (AI-JET)
Válvulas botão no painel (AI-JET2)



PNEUMATIC AUTOMATION

VÁLVULAS

Distribuidores **ESSENTIAL**

EL18/22

ALTO FLUXO

800 NI/min (G1/8) 1700 NI/min (G1/4)

DIMENSÕES COMPACTAS

18 mm (G1/8) 22 mm (G1/4)

SOLUÇÃO COMPLETA

5/2 - 5/3 - 3/2+3/2

ROBUSTO

Valvula corpo metallico

PS

Distribuidores COMBOBOX



GL6

Distribuidores e eletrodistribuidores 20 mm - Para base



AM

Pedais pneumáticos e elétricos



AC

Distribuidores MIXED
G1/8 - G1/4 - G1/2

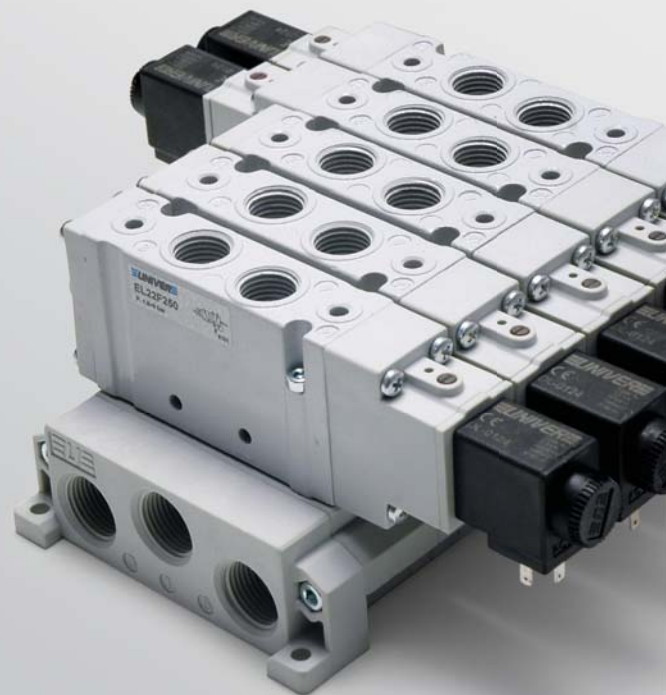

VÁLVULAS COMPACT

P10F

Distribuidores COMPACT 10 mm - M5



P10B

Distribuidores COMPACT 10 mm - Para base



P15F

Distribuidores COMPACT 15 mm - G1/8



P15B

Distribuidores COMPACT 15 mm - Para base

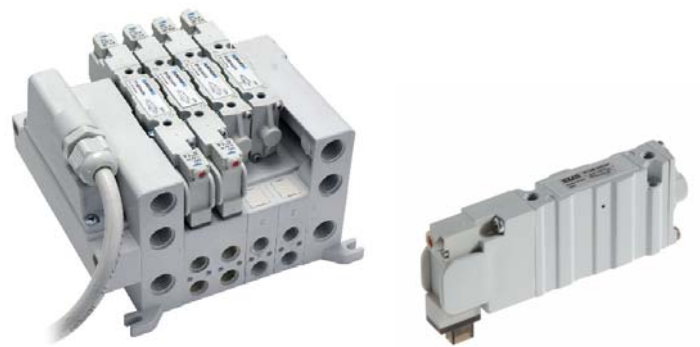

P10F

Distribuidores COMPACT 10 mm
Conector externo



Conector
EM LINHA

P15F

Distribuidores COMPACT 15 mm
Conector externo



Conector
EM LINHA

P15EF

Distribuidores COMPACT 15 mm - G1/8



SISTEMAS EM SÉRIE

TC

Conexões sistemas em série



Módulo em série
para todos os modelos
de Manifold



CANopen

PROFI
BUS

PROFI
NET

EtherNet/IP

DeviceNet

EtherCAT

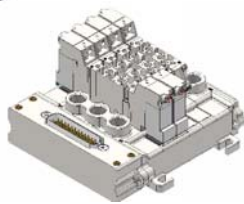

P10F

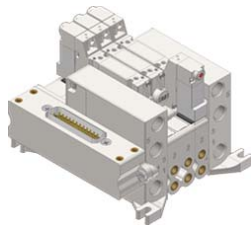

P10B

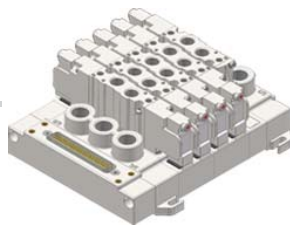

P15F



P15B

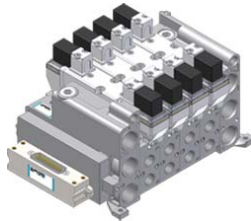

BD - 18 mm

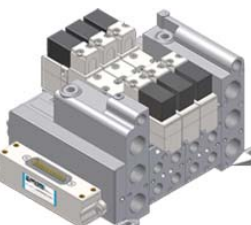

BD - 26 mm

PNEUMATIC AUTOMATION

VÁLVULAS

Distribuidores **COMPACT
P10/P15**

ALTO FLUXO

Tecnologia spool original UNIVER

DIMENSÕES COMPACTAS

Máxima redução das dimensões

INSTALAÇÃO SIMPLIFICADA

Todas as conexões pneumáticas no mesmo lado

SOLUÇÃO COMPLETA

Corpo rosqueado e para base

5/2 - 5/3 - 3/2+3/2



UNIDADE DE TRATAMENTO DE AR

HZE-F

Filtro
tamanho 0



HZE-R

Regulador
tamanho 0



HZE-L

Lubrificador
tamanho 0



HZE-B

Filtroregulador
tamanho 0



HZE-F

Filtro
tamanho 1-2



HZE-R

Regulador
tamanho 1-2



HZE-L

Lubrificador
tamanho 1-2



HZE-B

Filtroregulador
tamanho 1-2



HZE-Y

Válvula de arranque gradual
tamanho 0-1-2



HZE-N

Entrada de ar
tamanho 0-1-2



HZE-P

Válvula bloqueável
tamanho 0-1-2



HZE-S

Válvula de fechamento
tamanho 0-1-2



PNEUMATIC AUTOMATION

TRATAMENTO DE AR

HZE

MODULAR

40 mm (HZE0) 63 mm (HZE1) 80 mm (HZE2)

MANÔMETRO INTEGRADO

Padrão de série

SOLUÇÃO COMPLETA

Possibilidade de montar configurações com acessórios



HZE-D

Filtro com regulador + Lubrificador tamanho 0



HZE-C

Filtro + Regulador + Lubrificador tamanho 0



HZE-D

Filtro com regulador + Lubrificador tamanho 1-2



HZE-C

Filtro + Regulador + Lubrificador tamanho 1-2



HZ9464G

Manômetro embutido



HZ9P...

Manômetro redondo



UNIDADE DE TRATAMENTO DE AR

G1/4 Tamanho 0	G3/8 - G1/2 Tamanho 1	G1/2 Tamanho 2
 <p>FR+L</p> <p>600 NI/min</p>	 <p>FR+L</p> <p>2800 NI/min</p>	 <p>FR+L</p> <p>4300 NI/min</p>

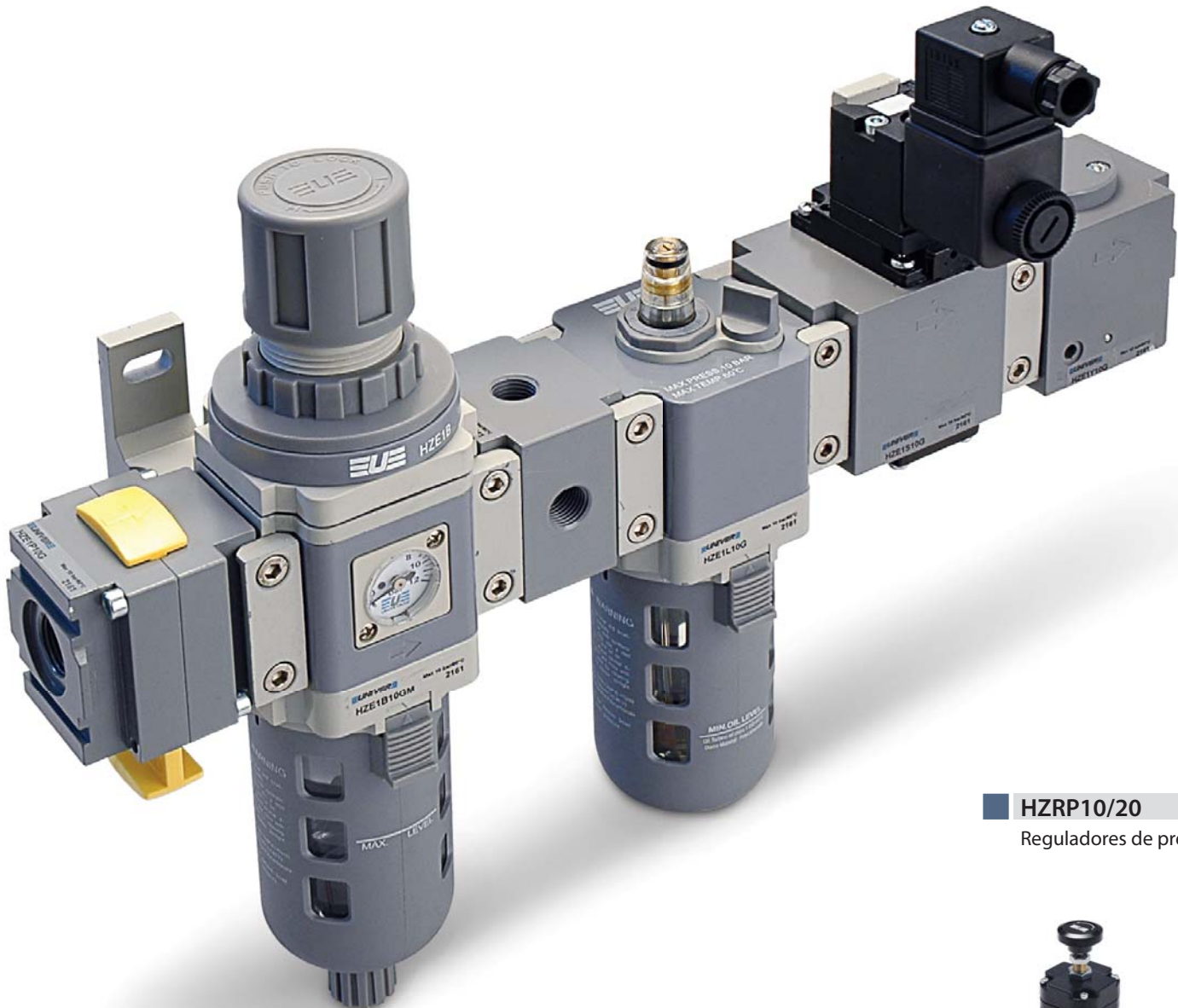

HZRP10/20
Reguladores de precisão



PNEUMATIC AUTOMATION

TRATAMENTO DE AR

HZE0R08G

Regulador sem manômetro
tamanho 0



HZE-RL

Regulador com cadeado
tamanho 1-2



HZE-R

Válvula de não retorno
tamanho 0-1-2



HZE-B

Válvula de não retorno
tamanho 0-1-2



HZE-S

Tamanho 0 U05

Tamanho 1 U05

Tamanho 1 U3 CNOMO



HZRE10/20

Transdutores
eletropneumáticos



HZRM08G

Micro-reguladores
para ar



HZRM...

Micro-reguladores
para ar e água



Filtro com regulador com pressostato digital



CONEXÕES E TUBOS

HA

Conexões automáticas em tecnopolímero



HAR

Conexões dimensões reduzidas



HB

Conexões automáticas em latão niquelado



HGC

Conexões PUSH-ON



HGO

Conexões de compressão



HGU

Engates rápidos para ar comprimido



VÁLVULAS COMPLEMENTARES E ACESSÓRIOS

AP

Contadores binários (flip flop)



AM-50

Reguladores de fluxo corpo metálico



AM-51

Válvulas processamento de sinais



AM-54

Válvulas de não retorno



AM-55

Válvulas de bloqueio



AM-5200

Transdutor pneumoelétrico



AM-5220

Pressostato regulável



PNEUMATIC AUTOMATION ACESSÓRIOS

HC

Conexões e acessórios com funções pneumáticas



HD

Conexões padrão pneumáticas



HEA/HEC/HED

HEA Tubos em poliamida
HEC Tubos em poliuretano
HED Tubos em co-poliuretano



HFA/HFC

HFA Tubo espiral em poliamida
HFC Tubo espiral em poliuretano



AM-52

Arranque progressivo



AM-53

Economizador



HZ9N

Pressostato digital



HZ9N12

Pressostato regulável com membrana



YF

Válvulas para fluidos G1/8 ÷ G1



Tanque ar/óleo
série **AM4**

NEW



GRAMPOS

UBP

UNIVERSAL Mini Clamp

Ø25/32



UBP/UBH

Grampo pneumático UNIVERSAL



IBP

Grampo pneumático UNIVERSAL intercambiável com tamanhos 50/63 mm



UBM/UBQ

Grampo pneumático UNIVERSAL com acionamento manual



IBM

Grampo pneumático UNIVERSAL intercambiável com tamanhos 50/63 mm, com acionamento manual



UBT

Grampo pneumático com acionamento manual central



PINÇA

UGP

Pinça pneumática



UGM

Pinça pneumática com acionamento manual



LGPS

Pinça pneumática **NEW**

Original UNIVER



AUTOMOTIVE

GRAMPO PINÇAS

UDP

Grampo pneumático com 2 braços



UNP

Grampo pneumático **UNIVERSAL** padrão N.A.A.M.S.



UFL/UHL

Grampo manual



UNM

Grampo pneumático **UNIVERSAL** com acionamento manual padrão N.A.A.M.S.



NEW

Unità di bloccaggio
a risparmio energetico

série **UA**

BLUECLAMP
air saving

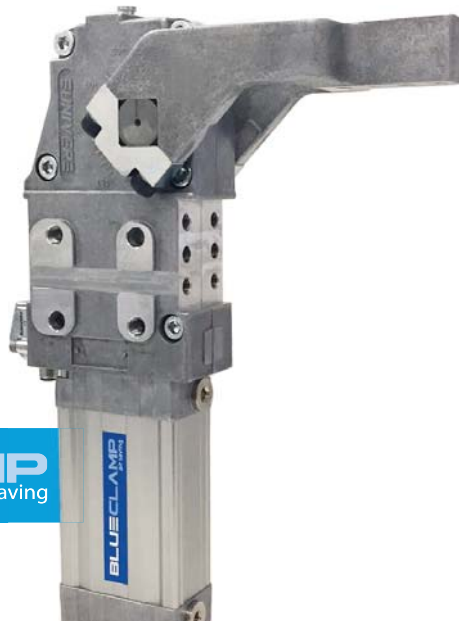

CONTÍNUA REGULAGEM

Ângulo de abertura regulável 0 ÷ 135°

PESO REDUZIDO

Braço e corpo em liga de alumínio

MECÂNISMO ORIGINAL UNIVER

Garante repetibilidade de posicionamento

SENSOR ÓTICO ORIGINAL UNIVER

Revestimento metálico

Conector M12 orientável



PINOS LOCALIZADORES

LCP

Pino localizador pneumático, haste simples



LCG

Pino localizador pneumático padrão CNOMO, haste simples



LCB/LCC

Unità di centraggio compatta, doppia guida



LCZ

Pino localizador pneumático irreversível, haste simples



LCT

Pino localizador pneumático irreversível, haste dupla



LCM

Pino localizador pneumático com acionamento manual, haste simples



LCL

Pino localizador manual, haste simples



LCO

Pino localizador pneumático com haste dupla e acionamento manual



GRAMPOS LOCALIZADORES

LSP

Grampo localizador pneumático



LSP50U

Grampo localizador pneumático, posicionado horizontalmente



LSPL

Unità di bloccaggio e centraggio per applicazioni con raggio laser



LTP

Grampo localizador pneumático com gancho retrátil



AUTOMOTIVE

PINOS LOCALIZADOR

GRAMPOS LOCALIZADORES

LCA

Pino localizador pneumático, haste dupla



LCS

Unità di centraggio con testate compatte, doppia asta



LCY

Pino localizador pneumático irreversível com acionamento manual, haste simples



LCX

Pino localizador pneumático com acionamento manual e haste dupla irreversível



LUP

Grampo localizador pneumático com gancho e pino retráteis

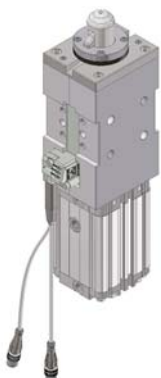

LSL

Grampo localizador com acionamento manual



Aplicações grampos e pino localizador pneumáticos

UNIDADES GIRATÓRIAS

LAGP

Unidade giratória



GRAMPOS ELÉTRICOS

LAE

Grampos elétricos

LNE

Grampos elétricos, fixação padrão N.A.A.M.S.

LGE

Pinças elétricas



TCE

Sistema di controllo modulare per Unità elettriche



Flessibile

compatibile con moduli I/O e
Manifold di valvole

**Sistema di
comunicazione seriale**

Power Unit

gestione efficiente della potenza

Driver unità elettriche

modulo di controllo per 2 unità
Max 8 unità elettriche



UNIDADES DE MARCAÇÃO

PRD

Datador com 1 caractere



PRP

Datador de 7 caracteres



LCE

Cilindros localizadores elétricos



LAGE

Unidades rotatórias elétricas

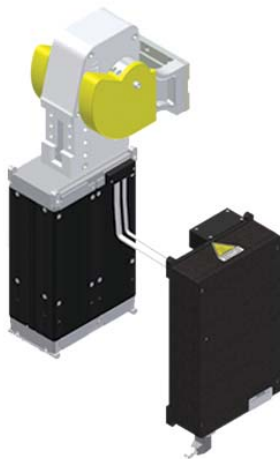

Aplicações unidades elétricas

AUTOMOTIVE

UNIDADES GIRATÓRIAS

UNIDADES DE MARCAÇÃO

GRAMPOS ELÉTRICOS



SISTEMA DE MANIPULAÇÃO MODULAR **GR8**

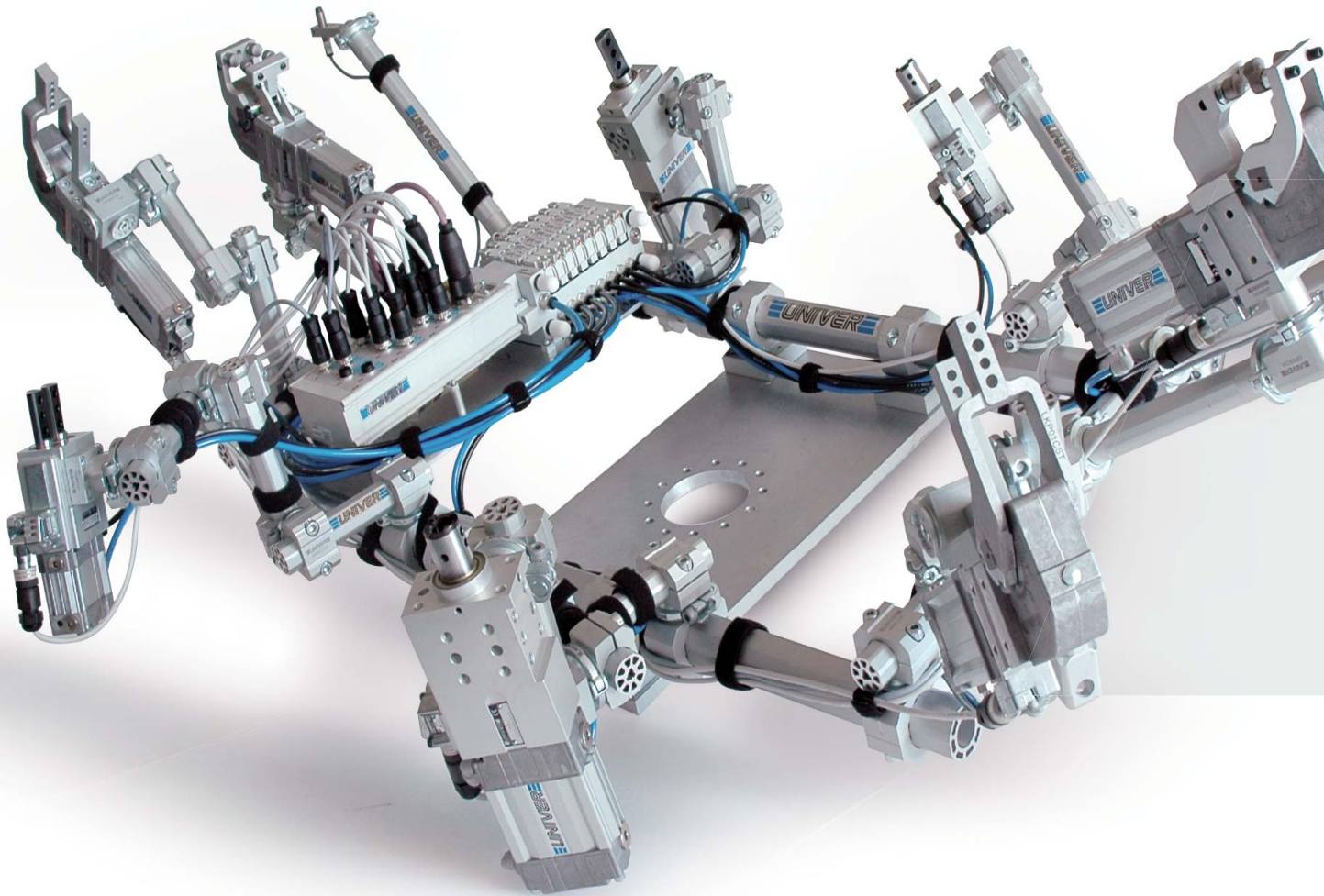

PERFIL Ø 30 - 45 - 70 mm

Rigidez máxima e peso mínimo

30



45



70

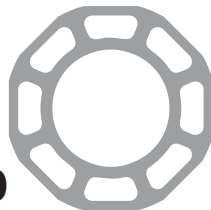

ANEL DE BLOQUEIO

Sistema eficiente que garante um alto nível de precisão de posicionamento

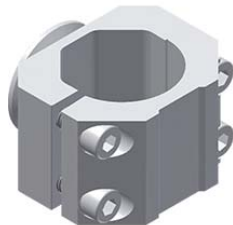

MODULAR TOOLING SYSTEM GARRAS GR8

KIT

Redução considerável
dos elementos de fixação



ALTA PRECISÃO

Alto nível de repetibilidade de posicionamento;
baixa deflexão

COMPONENTES MODULARES

Redução considerável dos elementos de fixação

INSTALAÇÃO E AJUSTES RÁPIDOS

Dispensa solda e tarugos
Componentes de fácil substituição

INTEIRAMENTE REGULÁVEL

Orientação ilimitada no espaço e livre configuração

Originale UNIVER **NEW**

ESFERA

Rotação giratória ilimitada



SISTEMA DE MANIPULAÇÃO MODULAR **GR8**

Aplicações e detalhes dos componentes

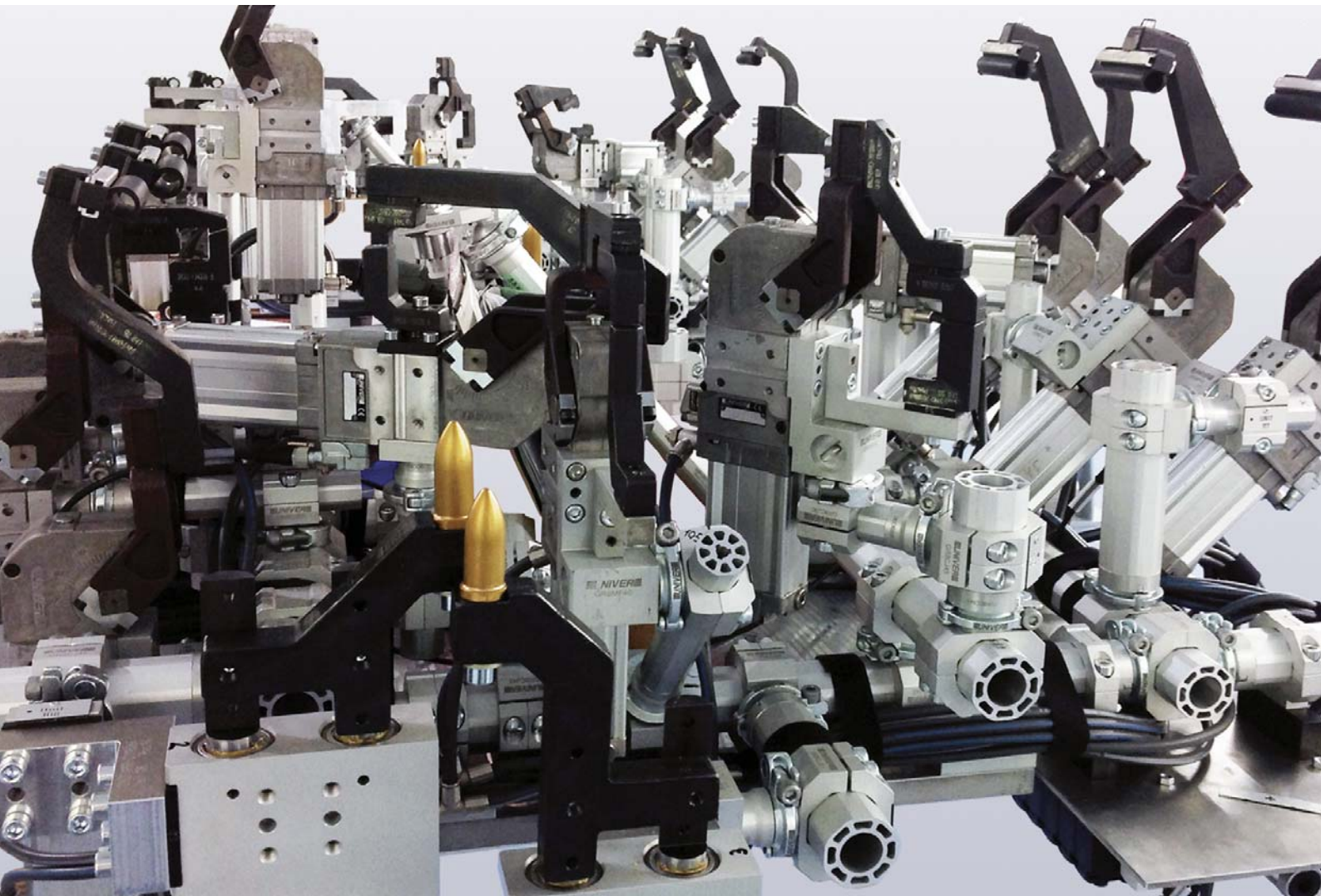

Configurações ilimitadas e complexas
Peso otimizado de todos os elementos de fixação
Rapidez de instalação e regulagem
Componentes modulares

MODULAR
TOOLING
SYSTEM
GARRAS GR8

SOLUÇÃO COMPLETA COM
COMPONENTES **UNIVER**

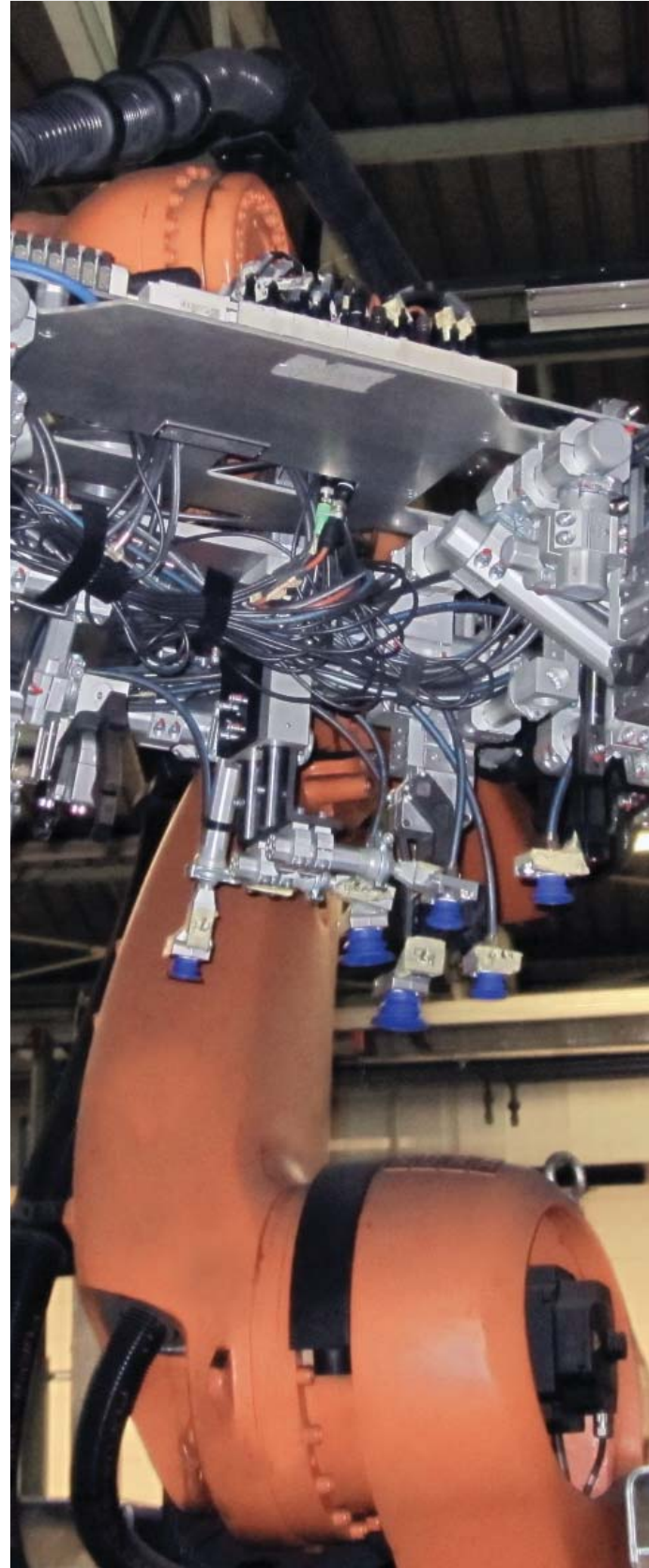
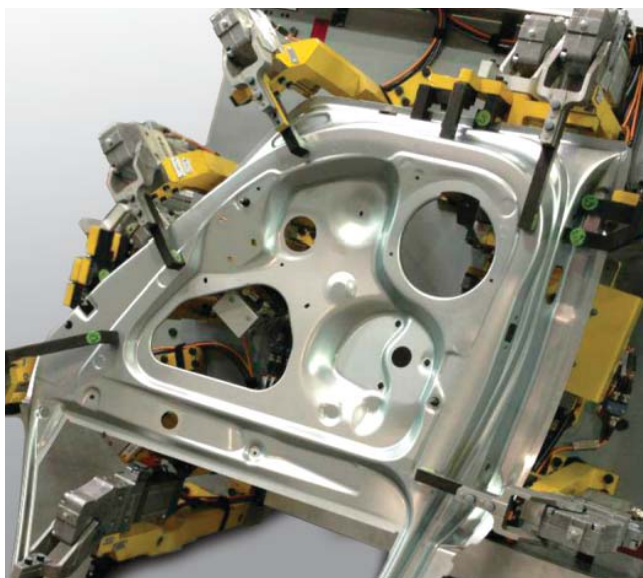



UNIVER S.p.A.

Headquarters

I - 20128 **Milano**
Via Eraclito, 31
Tel. +39 02 25298.1
Fax +39 02 2575254
info@univer-group.com
www.univer-group.com

UNIVER SERVICE S.r.l.

Headquarters

I - 20128 **Milano**
Via Empedocle, 20
Tel. +39 02 25298.1
Fax +39 02 25298370
universervice@universervice.it
www.universervice.it

Unidades operativas

LOMBARDIA

I - 20128 **Milano**
Via Empedocle, 20
Tel. +39 02 25298.1
Fax +39 02 25298370
universervice@universervice.it

I - 24060 Castelli Calepio **Bergamo**
Via C. Curotti, 31/33
Tel. +39 030 7435420
Fax +39 030 733328
castellicalepio@universervice.it

I - 22040 Monguzzo **Como**
Via Valassina, 18/b3
Tel. +39 031 617922
Fax +39 031 651222
monguzzo@universervice.it

PIEMONTE/LIGURIA/VALLE D'AOSTA

I - 10071 Borgaro Torinese **Torino**
Via Veneto, 18
Tel. +39 011 4501871
Fax +39 011 4502898
torino@universervice.it

VENETO/FRIULI VENEZIA-GIULIA TRENTINO-ALTO ADIGE

I - 30030 Vigonovo **Venezia**
Via Prima strada 16/A - Loc. Galta
Tel. +39 049 9834140
Fax +39 049 9833972
vigonovo@universervice.it

EMILIA ROMAGNA

I - 40069 Zola Predosa **Bologna**
Via Balzani, 5
Tel. +39 051 753907
Fax +39 051 6184751
bologna@universervice.it

CENTRO/SUD

I - 40069 Zola Predosa **Bologna**
Via Balzani, 5
Tel. +39 051 753907
Fax +39 051 6184751
bologna@universervice.it

UNIVER DO BRASIL S/A

BRAZIL - 13474-764
Americana **São Paulo**
Rua do Polyester, 29
Distrito Industrial Abdo Najar
Tel. +55 19 3113-9400
Fax +55 19 3113-9405
atendimento@univer.com.br

UNIVER CHINA

CHINA - Shanghai
399 Fu Te North Road,
Free Zone, Pudong
info@univer-china.com

UNIVER FRANCE S.a.s.

FRANCE - 68000
Colmar
1, rue Denis Papin
Tel. +33 3 89210900
Fax +33 3 89216850
info@univer-france.fr

UNIVER G.m.b.H.

GERMANY - D-65428
Rüsselsheim
Eisenstraße 51
Tel. +49 6142 408320
Fax +49 6142 4083290
info@univer-gmbh.de

UNIVER NORTH AMERICA

USA - 48312
Sterling Heights - **Michigan**
6620 Cobb Drive
Tel. +1 248 299 0525
Fax +1 248 299 0528
info@univer-group.us

UNIVER POLSKA Sp. z o.o.

POLAND - 25-663
Kielce
ul. K. Olszewskiego 21E
Tel. +48 41 278 72 53
Fax +48 41 278 72 54
univer@univer-group.pl

UNIVER S.L.

SPAIN - 08210
Barbera Del Valles **Barcelona**
Ronda Industria, 26 - 28
Tel. +34 93 7297360
Fax +34 93 7297380
univer@univerweb.com

Distribuidores no mundo:

Entrar em contato com o nosso Departamento
Comercial ou visite o site www.univer-group.com



www.univer-group.com