

# KD

Ø 32 ÷ 125 mm - Pneumatic cylinders ISO 15552

- Heavy series
- Grooves for DF recessed sensors
- Version with magnetic piston

Available ATEX version upon request

CE Ex II 2Gc IIC T5 II 2Dc T100°C



## TECHNICAL CHARACTERISTICS

Working temperature	-20 ÷ 80 °C
Fluid	filtered air, with or without lubrication
Working pressure	1,5 ÷ 10 bar
Bores	Ø 032 - 040 - 050 - 063 - 080 - 100 - 125 mm
Cushionings	adjustable in both sides

## CONSTRUCTIVE CHARACTERISTICS

End-caps	die-cast aluminium alloy (painted)
Barrel	anodized aluminium
Piston	die-cast aluminium alloy
Guide slide	acetalic resin
Piston rod	chromium-plated steel standard, stainless steel, rolled AISI 303
Piston seal	double-lip seal in nitrile rubber (NBR)
Guide bush for piston rod	UNIVER Original self-lubricating and self-aligning
Shock absorber seals	nitrile rubber (NBR) in both sides
Magnet	plasto-ferrite (standard supplied)

## CODIFICATION KEY

K	D	2	0	0	0	3	2	0	0	5	0		M	
1	2	3	4		5			6	7	8				

1 Series	2 Type	3 Version	4 Bore (mm)
<b>KD</b> = Ø 32÷125 mm - ISO 15552 Pneumatic cylinders (former ISO 6431 and VDMA 24562)	<b>1</b> = Stainless steel piston rod <b>2</b> = Chromium-plated steel piston rod	<b>00</b> = <b>D.A.</b> Standard version <b>01</b> = <b>D.A.</b> Through piston rod <b>60</b> = <b>S.A.</b> Retracted piston rod Max stroke 50 mm <b>70</b> = <b>S.A.</b> Extended piston rod Max stroke 50 mm	<b>032</b> = Ø32 <b>080</b> = Ø80 <b>040</b> = Ø40 <b>100</b> = Ø100 <b>050</b> = Ø50 <b>125</b> = Ø125 <b>063</b> = Ø63
Magnetic version standard supplied		<b>D.A.</b> = Double acting <b>S.A.</b> = Single acting	

5 Stroke (mm)	6 Option	7 Magnetic	8 Atex option
<b>0025</b> = 25 <b>0150</b> = 150 <b>0320</b> = 320 <b>0700</b> = 700 <b>0050</b> = 50 <b>0160</b> = 160 <b>0350</b> = 350 <b>0800</b> = 800 <b>0075</b> = 75 <b>0175</b> = 175 <b>0400</b> = 400 <b>0900</b> = 900 <b>0080</b> = 80 <b>0200</b> = 200 <b>0450</b> = 450 <b>1000</b> = 1000 <b>0100</b> = 100 <b>0250</b> = 250 <b>0500</b> = 500 <b>0125</b> = 125 <b>0300</b> = 300 <b>0600</b> = 600	<b>F</b> = Preset for locking unit reduced protrusion <b>G</b> = Preset for locking unit ISO protrusion	<b>M</b> = Magnetic version standard supplied	<b>X</b> = Atex (upon request)  See ATEX Catalogue for types and versions

**KD190 and KD290 versions with high temperature seals (max 120°C) available upon request**

Stroke tolerances

Ø	stroke ≤ 500	501 ≤ stroke ≤ 1000
	mm	mm
32	+2 - 0	+3,2 - 0
40	+2 - 0	+3,2 - 0
50	+2 - 0	+3,2 - 0
63	+2,5 - 0	+4 - 0
80	+2,5 - 0	+4 - 0
100	+2,5 - 0	+4 - 0
125	+4 - 0	+5 - 0

Single acting cylinder  
Theoretical forces (N) for return stroke

Ø	Max spring force at 0 stroke	Min. spring force at 0 stroke
32	52	28
40	70	42,5
50	98	48
63	98	48
80	140	80
100	140	80
125	235	175

Theoretical forces (N)  
at different working pressure (bar)

Ø	Surface area mm <sup>2</sup>		Working pressure bar					Working pressure bar				
	Thrust	Traction	Thrust					Traction				
			2	4	6	8	10	2	4	6	8	10
32	804	691	161	322	482	643	804	138	276	414	553	691
40	1256	1056	251	502	754	1005	1256	211	422	633	844	1055
50	1962	1649	393	785	1178	1570	1963	330	660	990	1320	1650
63	3116	2802	623	1246	1869	2493	3116	560	1120	1680	2240	2800
80	5024	4533	1005	2010	3014	4019	5024	907	1814	2722	3629	4536
100	7850	7359	1570	3140	4710	6280	7850	1472	2944	4416	5888	7360
125	12266	11462	2453	4906	7359	9812	12266	2294	4588	6882	9176	11470

Cushion

Ø	Length mm	Max kinetic energy absorption Nm
	32	18
40	24	2,5
50	24	4,5
63	30	8
80	30	12
100	35	21
125	35	36

Mass - Standard cylinder

Ø	Cylinder - stroke 0	Increase per mm stroke	Moving element - stroke 0	Increase per mm stroke
	g	g	g	g
32	530	2,8	130	0,9
40	800	4,0	240	1,6
50	1270	6,0	430	2,5
63	1760	6,2	470	2,5
80	2860	10,8	950	3,9
100	3950	13,4	1180	3,9
125	6870	18,6	2180	6,3

Mass - Through piston rod cylinder

Ø	Cylinder - stroke 0	Increase per mm stroke	Moving element - stroke 0	Increase per mm stroke
	g	g	g	g
32	660	3,7	200	1,8
40	950	5,5	370	3,2
50	1570	8,5	640	4,9
63	2050	8,7	750	4,9
80	3380	14,7	1370	7,7
100	4550	17,3	1600	7,7
125	8080	24,9	3200	12,6

Graph of theoretical forces/pressure  
and acceptable strokes depending on maximum peak load

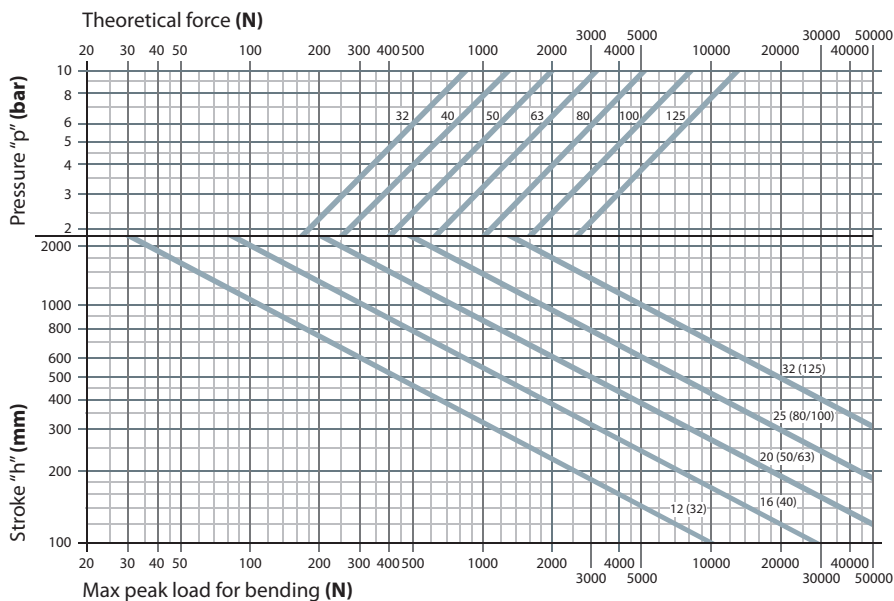

Fixing elements and accessories

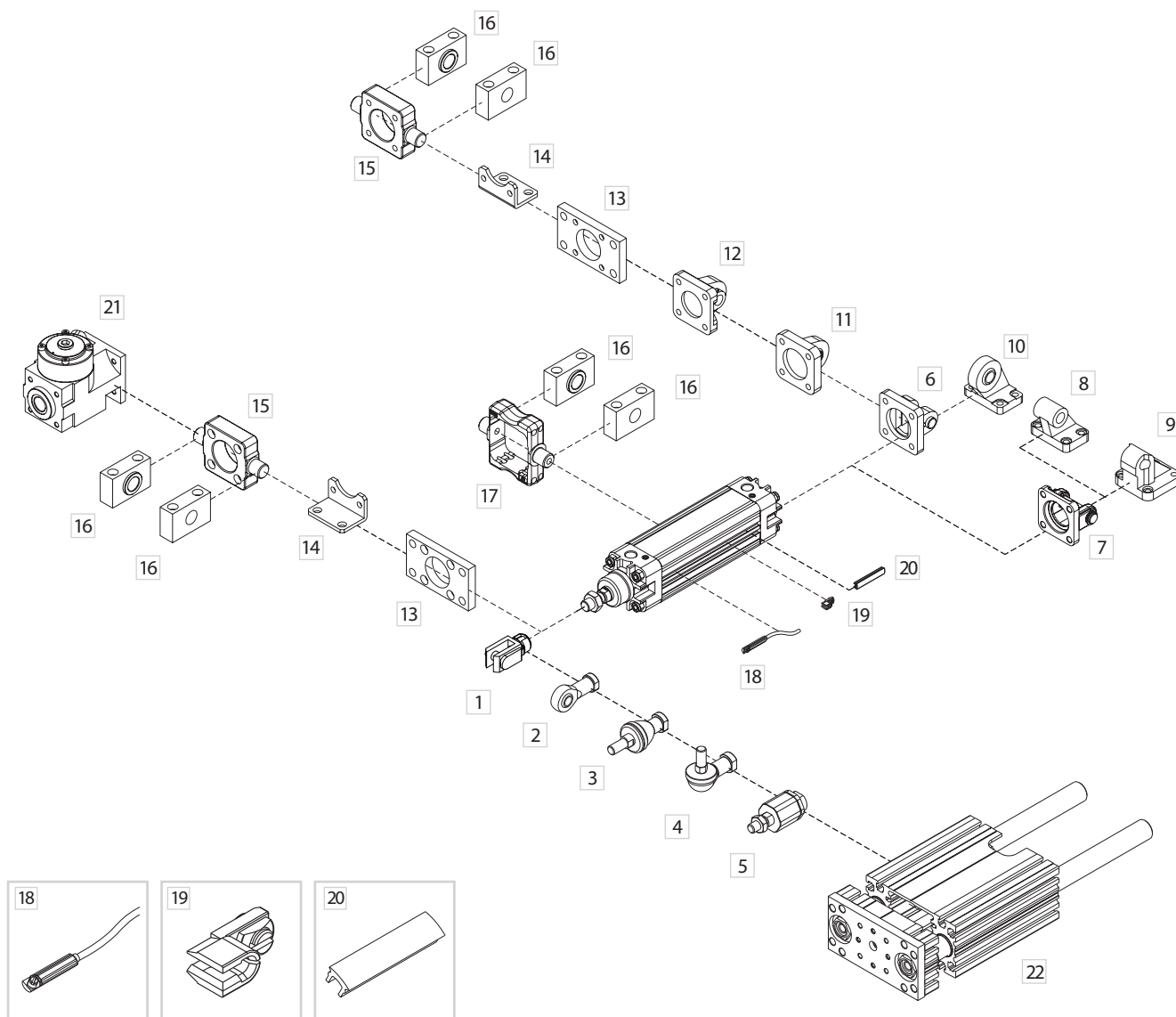

DESCRIPTION	PART NO.
1 Female fork with clips	KF-15 ___
2 Articulated self-lubricating fork	KF-17 ___
3 Fork with axially mounted articulated pin	KF-22 ___
4 Fork with angle-mounted articulated pin	KF-23 ___
5 Floating joint	KF-24 ___
6 Female hinge (ISO MP2) with pin	KF-10 ___ A
7 Narrow female hinge with pin (DIN648K)	KF-10 ___ AS
8 Counter-hinge 90° (CETOP RP107P)	KF-19 ___ CTA
9 Counter-hinge 90°	KF-19 ___
10 Articulated counter-hinge (DIN648K)	KF-19 ___ SC
11 Articulated rear male hinge (ISO MP6)	KF-11 ___ S
12 Rear male hinge (ISO MP4)	KF-11 ___
13 Front/rear flange (ISO MF1-MF2)	KF-12 ___
14 Angle bracket (ISO MS1)	KF-13 ___
15 Front/rear hinge with floating pin	KF-14 ___ AP
16 Hinge support	KF-41 ___
17 ISO intermediate hinge (ISO MT4)	KDF-14 ___
18 DF magnetic sensor (see accessories section)	DF- ___
19 Cable clamping for DF sensor (see accessories section)	DF-001
20 DHF covering strip (see accessories section)	DHF-0020100
21 Locking unit	L1-N
22 Slide unit	J12

### Double acting/Single acting

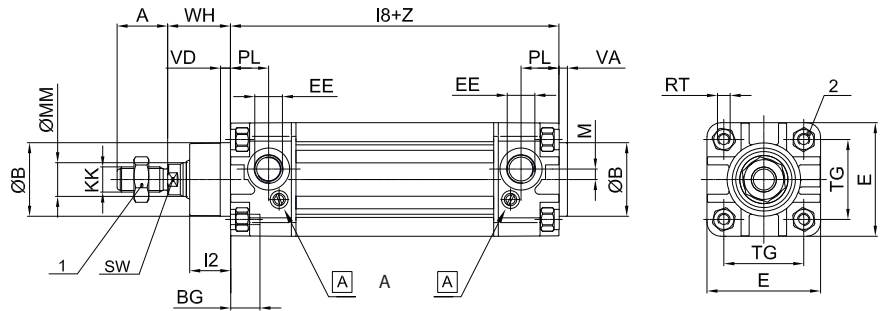
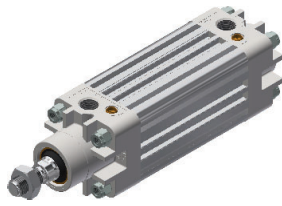

A Adjusting screw pneumatic cushioning

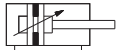
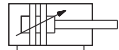

**KD100/200**  
D.A. Standard



**KD160/260**  
S.A. Retracted piston rod



**KD170/270**  
S.A. Extended piston rod

For extended rod version add **WH+Z**(stroke) dimensions

### Double acting through piston rod

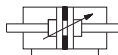
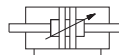
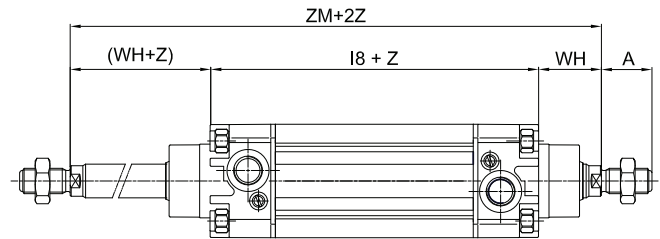
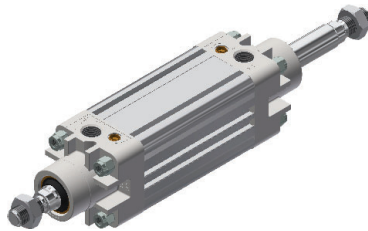

**KD101/201**  
D.A. Through piston rod

Z = Stroke

Ø	A	ØB	BG	E+0,5	KK	I2	I3	I8	PL	RT	SW	TG	VA	VD	WH	ØMM	EE	M	1	2	ZM
32	22	30	16	46,5	M10x1,25	16	5	94 ±0,4	14	M6	10	32,5 ±0,5	3,5	5	26	12	G1/8	4,4	17	6	146
40	24	35	16	52	M12x1,25	20	5	105 ±0,7	16	M6	13	38 ±0,5	4	5,5	30	16	G1/4	5	19	6	165
50	32	40	17	64,5	M16x1,5	26	6	106 ±0,7	15,5	M8	17	46,5 ±0,6	4	6	37	20	G1/4	6	24	8	180
63	32	45	18	76,5	M16x1,5	26	6	121 ±0,8	17,5	M8	17	56,5 ±0,7	4	6	37	20	G3/8	8	24	8	195
80	40	45	20	95	M20x1,5	32	7	128 ±0,8	20	M10	22	72 ±0,7	4	8	46	25	G3/8	7,5	30	10	220
100	40	55	20	114	M20x1,5	35	7	138 ±1	20,5	M10	22	89 ±0,7	4	8	51	25	G1/2	9	30	10	240
125	54	60	24	140	M27x2	45	8	160 ±1	20,5	M12	27	110 ±1,1	5,5	10	65	32	G1/2	11	41	12	290

## Tandem version

### CODIFICATION KEY

K	D	2	A	0	3	2	0	5	0	M
1	2	3	4	5						

1 Series	2 Type	3 Bore (mm)	4 Stroke (mm)	5 Magnetic
<b>KD</b> = Ø 32÷125 mm - ISO 15552 Pneumatic Cylinders (former ISO 6431 VDMA 24562) <b>Magnetic version standard supplied</b>	<b>1A</b> = Double thrust tandem only for forward movement, stainless steel piston rod <b>2A</b> = Double thrust tandem only for forward movement, chromium-plated steel piston rod <b>1D</b> = Double thrust tandem only for reverse movement, stainless steel piston rod <b>2D</b> = Double thrust tandem only for reverse movement, chromium-plated steel piston rod	<b>032</b> = Ø32 <b>080</b> = Ø80 <b>040</b> = Ø40 <b>100</b> = Ø100 <b>050</b> = Ø50 <b>125</b> = Ø125 <b>063</b> = Ø63	Upon request	<b>M</b> = Magnetic version (standard supplied)

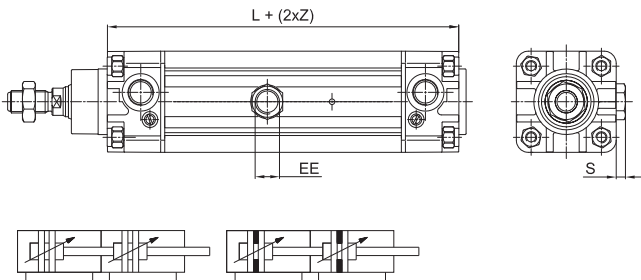

Z = Stroke

Ø	EE	L	S
32	G1/8	169	3
40	G1/4	189	5
50	G1/4	175	4
63	G3/8	195	7
80	G3/8	211	6
100	G1/2	224	9
125	G1/2	251	9

Tandem cylinders are constructed using two pistons coupled together which double the force in forward movement compared to the traditional ISO cylinders of the same bore size

## Two-position tandem version

### CODIFICATION KEY

K	D	2	B	0	3	2	0	0	5	0	0	0	7	0	M
1	2	3	4	5	6										

1 Series	2 Type	3 Bore (mm)	4 Stroke Z1 (mm)	5 Stroke Z2 (mm)	6 Magnetic
<b>KD</b> = Ø 32÷125 mm - ISO 15552 Pneumatic Cylinders (former ISO 6431 VDMA 24562) <b>Magnetic version standard supplied</b>	<b>1B</b> = Two-position tandem, stainless steel <b>2B</b> = Two-position tandem, chromium-plated steel	<b>032</b> = Ø32 <b>080</b> = Ø80 <b>040</b> = Ø40 <b>100</b> = Ø100 <b>050</b> = Ø50 <b>125</b> = Ø125 <b>063</b> = Ø63	Stroke of rear cylinder Upon request	Stroke of head cylinder Upon request	<b>M</b> = Magnetic version (standard supplied)

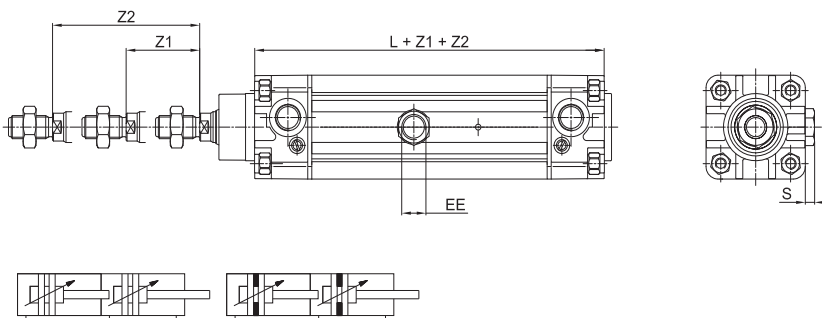

Z = Stroke

Ø	EE	L	S
32	G1/8	166	3
40	G1/4	186	5
50	G1/4	172	4
63	G3/8	192	7
80	G3/8	208	6
100	G1/2	221	9
125	G1/2	248	9

Two-position cylinders with two independent piston-rods which allow to realize a double positioning in which the thrust forces are the same as those of an ISO cylinder of the same bore size

For all other dimensions please refer to the standard version.  
 For other types of cylinders kindly contact our sales office

## Opposed tandem version

### CODIFICATION KEY

K	D	2	C	0	3	2	0	3	0	0	5	0	M
1	2	3	4	5	6								

1 Series	2 Type	3 Bore (mm)	4 Stroke Z1 (mm)	5 Stroke Z2 (mm)	6 Magnetic
<b>KD</b> = Ø 32÷125 mm - ISO 15552 Pneumatic Cylinders (former ISO 6431 VDMA 24562) <b>Magnetic version standard supplied</b>	<b>1C</b> = Opposed tandem, stainless steel <b>2C</b> = Opposed tandem, chromium-plated steel	<b>032</b> = Ø32 <b>040</b> = Ø40 <b>050</b> = Ø50 <b>063</b> = Ø63 <b>080</b> = Ø80 <b>100</b> = Ø100 <b>125</b> = Ø125	Shorter stroke (upon request)	Longer stroke (upon request)	<b>M</b> = Magnetic version (standard supplied)

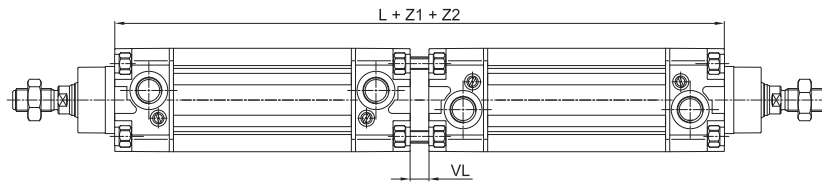

Ø	Z = Stroke	
	L	VL
32	194	6
40	220	10
50	222	10
63	252	10
80	266	10
100	288	12
125	334	14

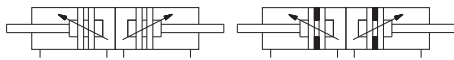

1

Type of cylinder characterized by the coupling of two cylinders and whose piston rods move in opposite directions. The values of the thrust force are the same as those of the traditional cylinders

## With common piston rod tandem version (upon request)

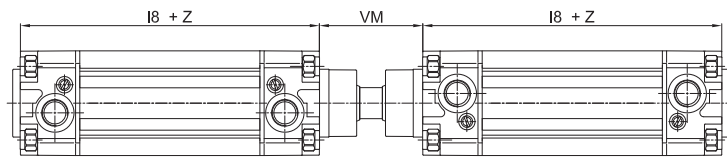

Ø	Z = Stroke		
	I8	VM	
32	94	±0,4	48
40	105	±0,7	54
50	106	±0,7	69
63	121	±0,8	69
80	128	±0,8	86
100	138	±1	91
125	160	±1	119

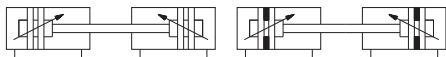

Two coupled cylinders with common piston rod  
The values of the thrust force are the same as those of the traditional cylinders.  
For all other dimensions please refer to the standard version.  
For other types of cylinders kindly contact our sales office.

Female rear hinge (ISO MP2) with pin

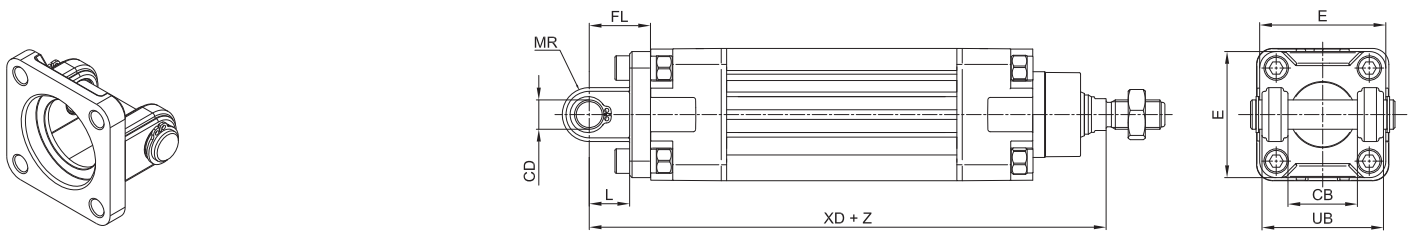

Material: Aluminium, zinc-plated steel pin

Z = Stroke

Ø	CB	CD	E	FL	L	MR	UB	XD		Mass	Part no.
	H14	H9		± 0,2	min.	Max	h14			g	
32	26	10	48	22	12	11	45	142	±1,25	75	KF-10032A
40	28	12	54	25	15	13	52	160	±1,25	110	KF-10040A
50	32	12	65	27	15	13	60	170	±1,25	150	KF-10050A
63	40	16	75	32	20	17	70	190	±1,6	270	KF-10063A
80	50	16	95	36	20	17	90	210	±1,6	420	KF-10080A
100	60	20	115	41	25	21	110	230	±1,6	765	KF-10100A
125	70	25	140	50	30	26	130	275	±2	1445	KF-10125A

Narrow female hinge with pin (DIN648K)

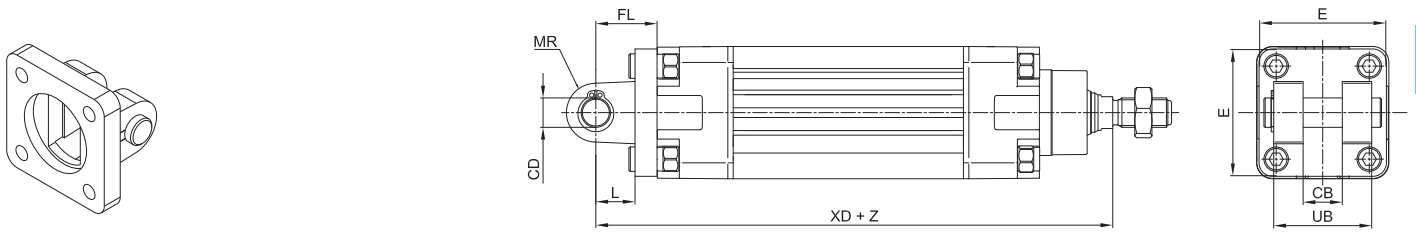

Material: Aluminium, zinc-plated steel pin

Z = Stroke

Ø	CB	CD	E	FL	L	MR	UB	XD		Mass	Part no.
	H14	H9		± 0,2	min.	Max	h14			g	
32	14	10	45	22	13	10	34	142	±1,25	68	KF-10032AS
40	16	12	52	25	16	12	40	160	±1,25	112	KF-10040AS
50	21	16	65	27	16	14	45	170	±1,25	196	KF-10050AS
63	21	16	75	32	21	18	51	190	±1,6	288	KF-10063AS
80	25	20	95	36	22	20	65	210	±1,6	566	KF-10080AS
100	25	20	115	41	27	22	75	230	±1,6	818	KF-10100AS
125	37	30	140	50	30	25	97	275	±2	1706	KF-10125AS

1  
CYLINDERS

Pin for female hinge

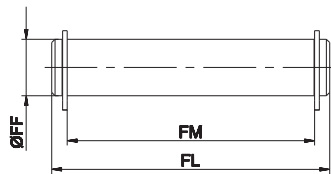

Pin for narrow female hinge

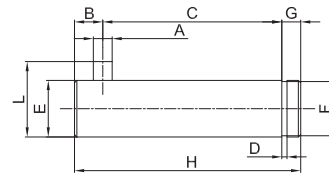

Including 2 circlips

Material: Zinc-plated steel

Ø	FF	FL	FM	Mass	Part no.*
	f8			g	
32	10	53	46	30	KF-18032
40	12	61,3	53	50	KF-18040
50	12	69	61	50	KF-18050
63	16	80,5	71	120	KF-18063
80	16	100,5	91	150	KF-18080
100	20	122,5	111	290	KF-18100
125	25	140	131	1530	KF-18125

Including circlip

Material: Zinc-plated steel

Ø	A	C	D	E	F	G	H	L	B	Mass	Part no.
	H12	$\begin{smallmatrix} +0,5 \\ -0,3 \end{smallmatrix}$	h13	f7	h11			$\begin{smallmatrix} 0 \\ -0,5 \end{smallmatrix}$	g		
32	3	32,5	1,1	10	9,6	4	41	14	4,5	26	KF-18032S
40	4	38	1,1	12	11,5	4	48	16	6	42	KF-18040S
50	4	43	1,1	16	15,2	5	54	20	6	84	KF-18050S
63	4	49	1,1	16	15,2	5	60	20	$\begin{smallmatrix} 0 \\ -1 \end{smallmatrix}$	94	KF-18063S
80	4	63	1,3	20	19	6	75	24	6	184	KF-18080S
100	4	73	1,3	20	19	6	85	24	6	208	KF-18100S
125	6	94	1,6	30	28,6	7	110	36	$\begin{smallmatrix} 0 \\ -2 \end{smallmatrix}$	606	KF-18125S

\* = Pin for part no. KF-10...

Rear male hinge (ISO MP4)

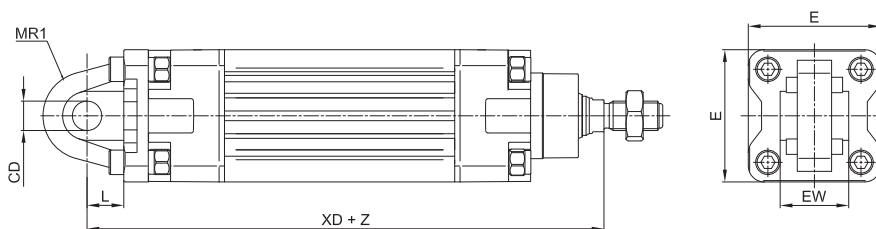
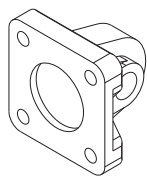

Material: Aluminium

Z = Stroke

Ø	CD	E	EW	L	MR1	XD	Mass	Part no.	
	H9								min.
32	10	48	26	-0,2 / -0,6	12	142	±1,25	80	KF-11032
40	12	54	28	-0,2 / -0,6	15	160	±1,25	100	KF-11040
50	12	65	32	-0,2 / -0,6	15	170	±1,25	170	KF-11050
63	16	75	40	-0,2 / -0,6	20	190	±1,6	250	KF-11063
80	16	95	50	-0,2 / -0,6	20	210	±1,6	420	KF-11080
100	20	115	60	-0,2 / -0,6	25	230	±2	660	KF-11100
125	25	140	70	-0,5 / -1,2	30	275	±1,25	1500	KF-11125

\* = Non-standard dimension

Articulated rear male hinge (ISO MP6)

1

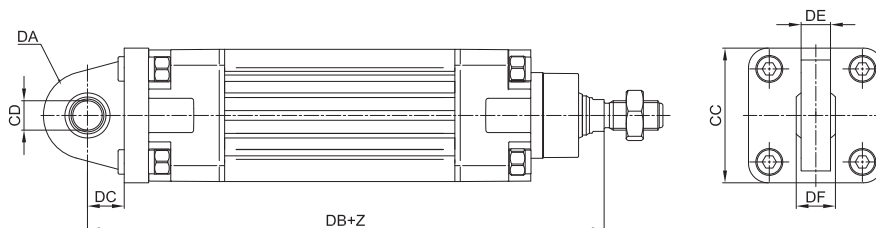
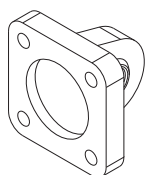

Material: Aluminium

Z = Stroke

Ø	CC	CD	DA	DB	DC	DE	DF	Mass	Part no.
		H9						g	
32	48	10	15	142	14	10,5	14	100	KF-11032S
40	54	12	18	160	16,5	12	16	200	KF-11040S
50	65	12	20	170	17,5	12	16	300	KF-11050S
63	75	16	21	190	21,5	15	21	350	KF-11063S
80	95	16	27	210	24	15	21	1600	KF-11080S
100	115	20	29,5	230	28	18	25	700	KF-11100S
125	140	30	40	275	30	25	37	1410	KF-11125S

Front/rear flange (ISO MF1-MF2)

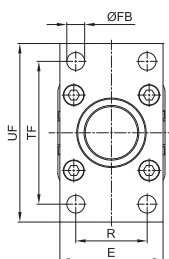
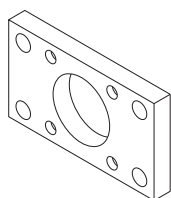

> Rear assembly

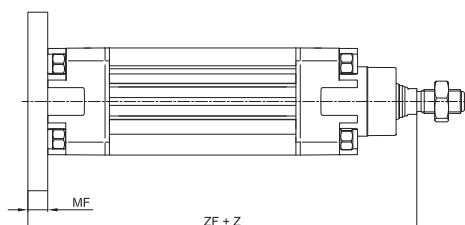

> Front assembly

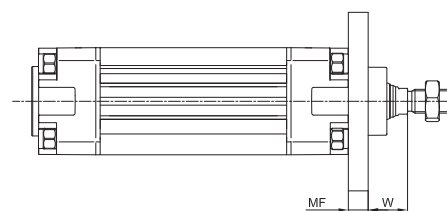

Material: Zinc-plated steel

Z = Stroke

Ø	E	ØFB	MF	R	TF	UF	W	ZF	Mass	Part no.		
		H13	± 0,2	JS14	JS14	Max					g	
32	45	7	10	32	64	80	16	±1,6	130	±1,25	200	KF-12032
40	52	9	10	36	72	90	20	±1,6	145	±1,25	250	KF-12040
50	65	9	12	45	90	110	25	±2	155	±1,25	500	KF-12050
63	75	9	12	50	100	120	25	±2	170	±1,6	650	KF-12063
80	95	12	16	63	126	150	30	±2	190	±1,6	1500	KF-12080
100	115	14	16	75	150	170	35	±2	205	±1,6	2200	KF-12100
125	140	16	20	90	180	205	45	±2,5	245	±2	4100	KF-12125



Angle bracket (ISO MS1)

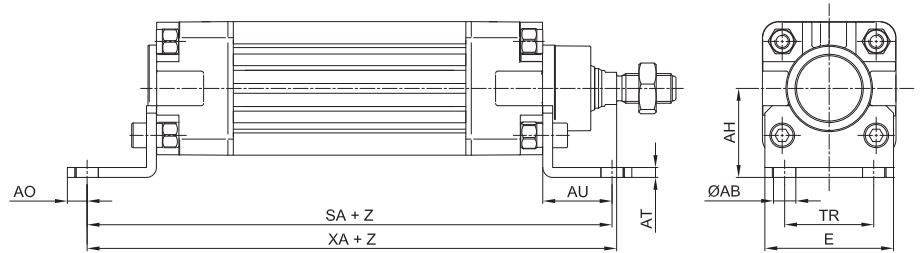
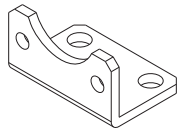

Material: Zinc-plated steel

Z = Stroke

Ø	ØAB	AH	AO	AT	AU	E	SA		TR	XA	Mass	Part no.	
	H13	JS15					±0,2	JS14					
32	7	32	6	4	24	45	142	±1,25	32	144	±1,25	55	KF-13032
40	9	36	8	4	28	52	161	±1,25	36	163	±1,25	80	KF-13040
50	9	45	10	5	32	64	170	±1,25	45	175	±1,25	146	KF-13050
63	9	50	12	5	32	74	185	±1,6	50	190	±1,6	175	KF-13063
80	12	63	15	6	41	94	210	±1,6	63	215	±1,6	390	KF-13080
100	14	71	20	6	41	114	220	±1,6	75	230	±1,6	525	KF-13100
125	16	90	15	8	45	140	250	±2	90	270	±2	1040	KF-13125

ISO intermediate hinge (ISO MT4)

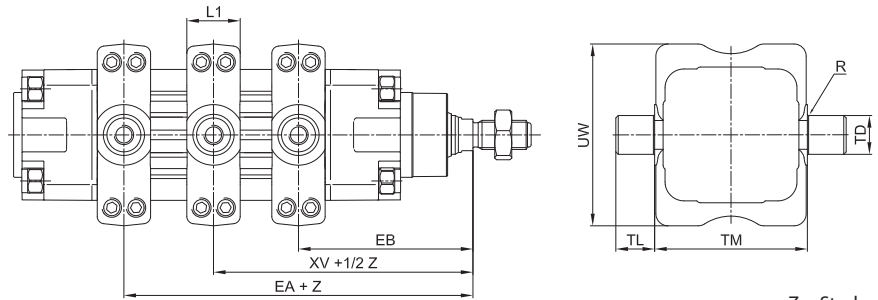
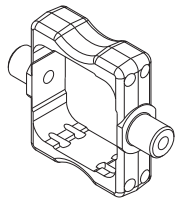

Material: Zinc-plated steel

Z = Stroke

Ø	EA	EB	L1	R	TD	TL	TM	UW	XV		Mass	Part no.
	Max	min.							e9	h14		
32	82	64	22	0,5	12	12	50	65	73	±2	120	KDF-14032
40	93	72	22	0,5	16	16	63	75	82,5	±2	240	KDF-14040
50	101	79	22	1	16	16	75	95	90	±2	320	KDF-14050
63	107	88	28	1	20	20	90	105	97,5	±2	470	KDF-14063
80	123	97	28	1	20	20	110	130	110	±2	800	KDF-14080
100	131	109	34	1	25	25	132	145	120	±2	1500	KDF-14100
125	164	126	34	1,5	25	25	160	175	145	±2,5	1920	KDF-14125

The dimension XV + 1/2 indicates the position of the hinge between the end-caps of the cylinder

Front/rear hinge with floating pin

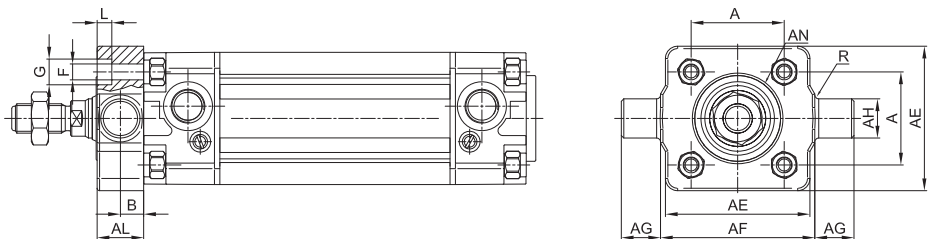
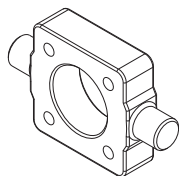

Material: Zinc-plated steel

Ø	AE	AL	AH	AG	AF	AN	A	B	F	G	L	R	Mass	Part no.
	Max	Max	e9	h14	h14	h11	±0,2	±0,2/0	H13	H13	+0,5/0	0/-0,3	g	
32	46	14	12	12	50	30	32,5	6,5	6,5	-	6	1	137	KF-14032AP
40	59	19	16	16	63	35	38	9	6,5	10,5	6	1,6	385	KF-14040AP
50	69	19	16	16	75	40	46,5	9	8,5	13,5	8	1,6	513	KF-14050AP
63	84	24	20	20	90	45	56,5	11,5	8,5	13,5	8	1,6	1041	KF-14063AP
80	102	24	20	20	110	45	72	11,5	10,5	16,5	10	1,6	1567	KF-14080AP
100	125	29	25	25	132	55	89	14	10,5	16,5	10	2	3000	KF-14100AP
125	155	32	25	25	160	133	110	-	13,5	20	12	2	2400	KF-14125AP

Counter hinge 90°

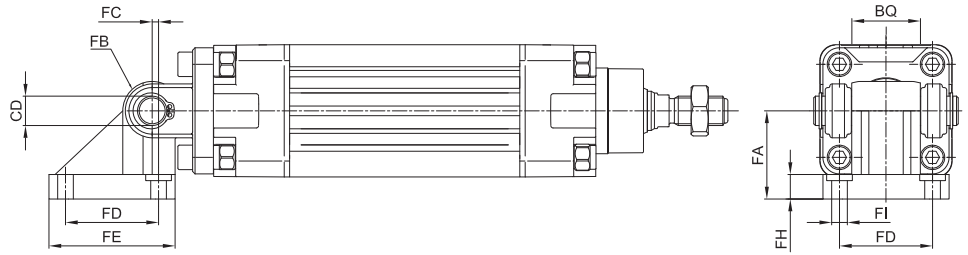
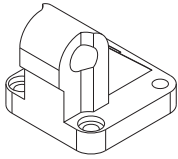

Material: Aluminium

Ø	CD	FA	FB	FC	FD	FE	FH	FI	F1	F2	BQ	Mass	Part no.	
	H9											g		
32	10	32	10	1,2	32,5	46,5	9	6,4	5,5	10,5	26	-0,2 -0,6	90	KF-19032
40	12	36	12	2,6	38	51,5	9	6,4	5,5	10,5	28		120	KF-19040
50	12	45	12	0,3	46,5	63,5	9	8,4	5	13,5	32		200	KF-19050
63	16	50	16	3,3	56,5	73,5	10,5	8,4	5	13,5	40		320	KF-19063
80	16	63	16	1,0	72	93	12	10,5	4,5	16,5	50		580	KF-19080
100	20	73	20	2,5	89	113	13	10,5	4,5	16,5	60		910	KF-19100

Counter hinge 90° (CETOP RP107P)

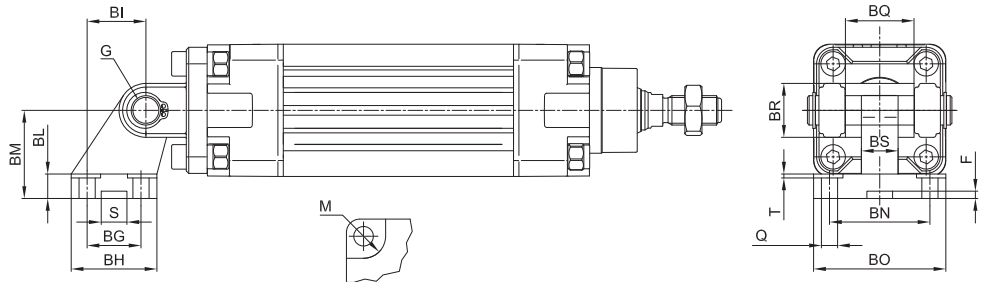
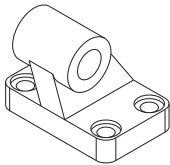

Material: Aluminium

Ø	Q	M	BG	BH	BI	BL	BM	BN	BO	BS	BR	T	G	S	F	BQ	Massa	Part no.
	H13	H13	JS14	Max	JS14		JS15	JS14	Max	Max	Max	Max	H9	+0,5/0	+0,5/0		g	
32	6,6	11	18	31	21	8	32	38	51	10	20	1,6	10	10,5	3	26	56	KF-19032CTA
40	6,6	11	22	35	24	10	36	41	54	15	22	1,6	12	10,5	3	28	139	KF-19040CTA
50	9	15	30	45	33	12	45	50	65	16	26	1,6	12	10,5	3	32	142	KF-19050CTA
63	9	15	35	50	37	14	50	52	67	16	30	1,6	16	10,5	3	40	200	KF-19063CTA
80	11	18	40	60	47	14	63	66	86	20	30	2,5	16	10,5	3	50	321	KF-19080CTA
100	11	18	50	70	55	17	71	76	96	20	38	2,5	20	10,5	3	60	656	KF-19100CTA
125	14	20	60	90	70	20	90	94	124	30	45	3,2	25	10,5	3	70	826	KF-19125CTA

Articulated counter hinge (DIN648K)

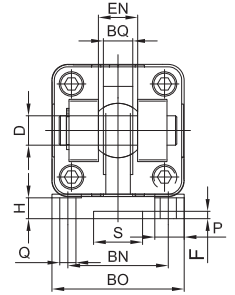
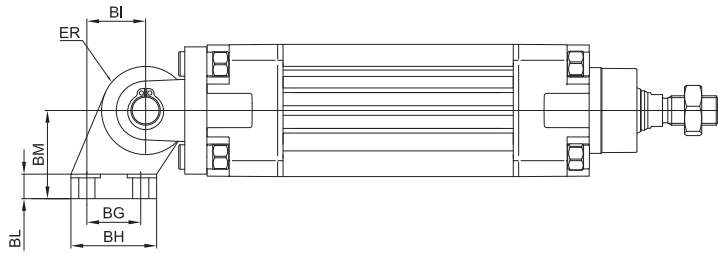
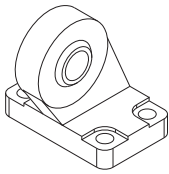

Material: Aluminium

Ø	Q	P	BG	BH	BI	BL	BM	BN	BO	EN	ER	BQ	D	H	S	F	g	Part no.
	H13	H13	JS14	Max	JS15		JS15	JS14	Max	0/-0,1	Max	Max	H7	+0,5/0	H13			
32	6,6	11	18	31	21	10	32	38	51	14	15	10,5	10	8,5	20	3	178	KF-19032SC
40	6,6	11	22	35	24	10	36	41	54	16	18	12	12	8,5	20	3	268	KF-19040SC
50	9	15	30	45	33	12	45	50	65	21	20	15	16	10,5	20	3	458	KF-19050SC
63	9	15	35	50	37	12	50	52	67	21	23	15	16	10,5	20	3	550	KF-19063SC
80	11	18	40	60	47	14	63	66	86	25	27	18	20	11,5	20	3	970	KF-19080SC
100	11	18	50	70	55	15	71	76	96	25	30	18	20	12,5	20	3	1326	KF-19100SC
125	13,5	20	60	90	70	20	90	94	124	37	40	25	30	17	20	3	3000	KF-19125SC

Hinge support

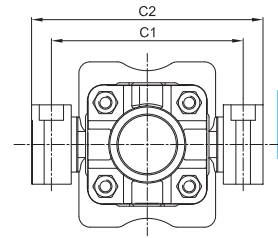
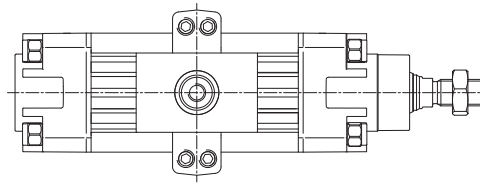
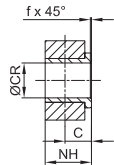
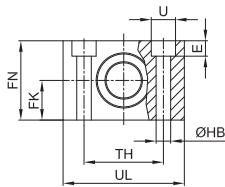
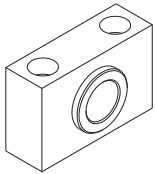

Material: Aluminium body and brass bushing

Ø	C	ØCR	FK	FN	ØHB	NH	TH	UL	ØU	E	f	C1	C2	Mass	Part no.
	H9	f7	±0,1				±0,1			±0,5				g	
32	10,5	12	15	30	6,6	18	32	46	11	7	1	71	86	100	KF-41032
40	12	16	18	36	9	21	36	55	15	9	1,6	87	105	150	KF-41040050
50	12	16	18	36	9	21	36	55	15	9	1,6	99	117	150	KF-41040050
63	13	20	20	40	11	23	42	65	18	11	1,6	116	136	234	KF-41063080
80	13	20	20	40	11	23	42	65	18	11	1,6	136	156	234	KF-41063080
100	16	25	25	50	14	28,5	50	75	20	13	2	164	189	435	KF-41100125
125	16	25	25	50	14	28,5	50	75	20	13	2	192	217	435	KF-41100125

Locking unit for ISO cylinder Ø 32 ÷ 125

> ISO protrusion

> Reduced protrusion

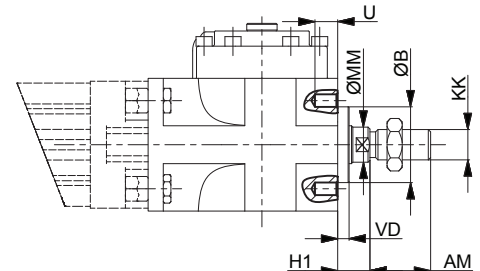
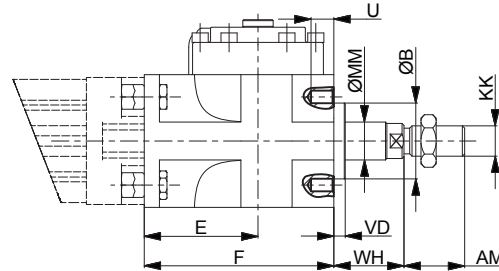
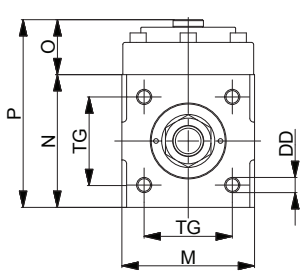

> Additional length to standard rod  
S<sub>1</sub> for ISO protrusion  
S<sub>2</sub> for reduced protrusion

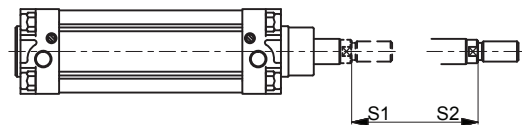

Ø	AM	B	DD	E	F	H1	KK	M	MM	N	O	P	S1	S2	TG	U	VD	WH
32	22	30	M6	54,5	84	16	M10 x 1,25	50	12	50	29,5	79,5	85	75	32,5	10	6	26
40	24	35	M6	58	90	15	M12 x 1,25	58	16	58	29,5	87,5	90	75	38	9	6	30
50	32	40	M8	60	100	17	M16 x 1,5	70	20	70	29	99	100	80	46,5	10	6	37
63	32	45	M8	65	110	17	M16 x 1,5	85	20	85	37	122	110	90	56,5	13	6	37
80	40	45	M10	75	125	21	M20 x 1,5	100	25	100	40,5	140,5	125	100	72	16	8	46
100	40	55	M10	90	152	26	M20 x 1,5	116	25	116	59	179	150	125	89	18	8	51
125	54	60	M12	112,5	185	35	M27 x 2	145	32	145	62	207	185	155	110	22	9,5	65

**Female fork with clips**

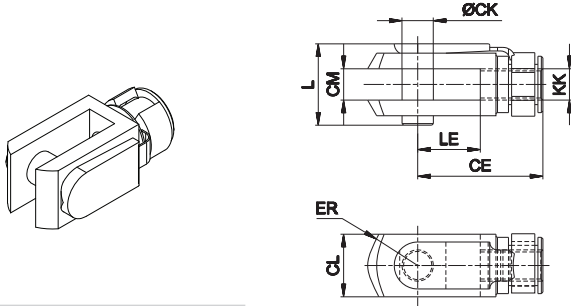

Material: Zinc-plated steel

Ø	CE	CK	CL	CM	ER	KK	L	LE	Mass g	Part no.
32	40	10	20	10	16	M10x1,25	26	20	90	KF-15032
40	48	12	24	12	19	M12x1,25	32	24	150	KF-15040
50 - 63	64	16	32	16	25	M16x1,5	40	32	340	KF-15050
80 - 100	80	20	40	20	32	M20x1,5	50	40	670	KF-15080
125	110	30	55	30	45	M27x2	65	54	1790	KF-15125

Fork with pin for piston rod according to ISO 8140 standard with

**Articulated self-lubricating fork**

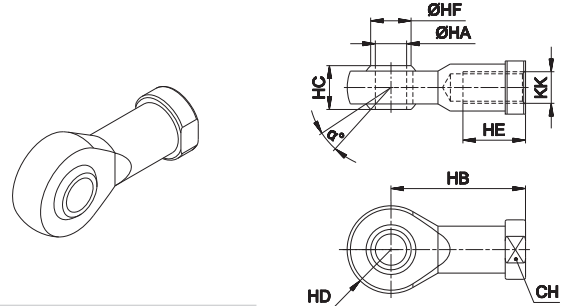

Material: Zinc-plated steel

Ø	α°	CH	KK	HA	HB	HC	HD	HE	HF	Mass g	Part no.
32	13	17	M10x1,25	10	43	14	14	20	12,9	76	KF-17032
40	13	19	M12x1,25	12	50	16	16	22	15,4	110	KF-17040
50 - 63	15	22	M16x1,5	16	64	21	21	28	19,3	220	KF-17050
80 - 100	14	30	M20x1,5	20	77	25	25	33	24,3	400	KF-17080
125	17	41	M27x2	30	110	37	35	51	34,8	1119	KF-17125

**Fork with axially mounted articulated pin**

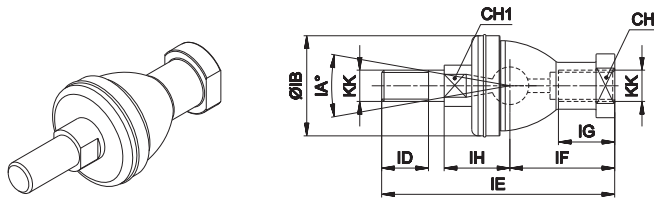

Material: Zinc-plated steel

Ø	CH	CH1	IA°	KK	IH	IB	ID	IE	IF	IG	Mass g	Part no.
32	17	11	30	M10x1,25	19,5	32	15	74,5	35	18	120	KF-22025
40	19	17	30	M12x1,25	22	36	17	84	40	20	185	KF-22040
50 - 63	22	19	22	M16x1,5	27,5	47	23	112	50	27	360	KF-22050
80 - 100	30	24	15	M20x1,5	31,5	58	25	133	63	38	570	KF-22080
125	-	-	-	-	-	-	-	-	-	-	-	-

**Fork with angle mounted articulated pin**

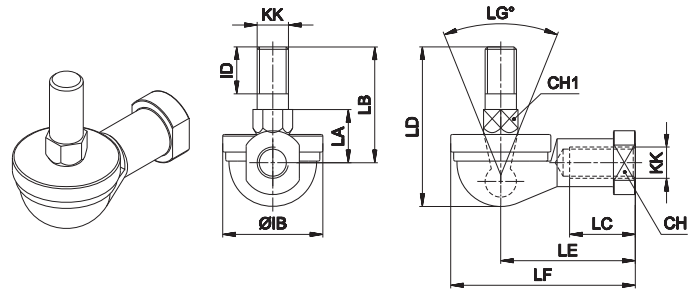

Material: Zinc-plated steel

Ø	CH	CH1	LG°	KK	IB	ID	LA	LB	LC	LD	LE	LF	Mass g	Part no.
32	17	11	50	M10x1,25	32	15	17	37	21	50,5	43	57	110	KF-23025
40	19	17	50	M12x1,25	36	17	19	42	27	57,5	50	66	165	KF-23040
50 - 63	22	19	40	M16x1,5	47	23	23,5	60	33	79,5	64	84	330	KF-23050
80 - 100	30	24	32	M20x1,5	58	25	27	68	40	90	77	99	540	KF-23080
125	-	-	-	-	-	-	-	-	-	-	-	-	-	-

**Floating joint**

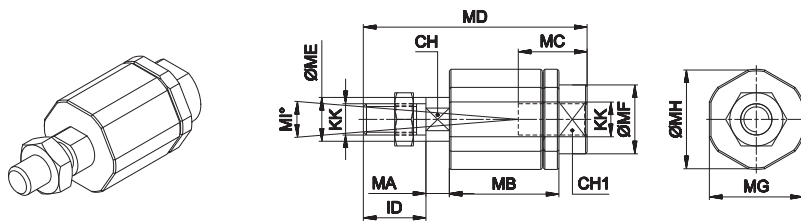

Material: Zinc-plated steel

Ø	CH	CH1	ID	KK	MA	MB	MC	MD	ME	MF	MG	MH	MI°	Mass g	Part no.
40	12	19	75	M12x1,25	5	35	20	75	14	22	30	32	8	230	KF-24040
50 - 63	20	30	103	M16x1,5	8	54	32	103	22	32	41	45	6	660	KF-24050
80 - 100	20	30	119	M20x1,5	8	54	40	119	22	32	41	45	6	700	KF-24080
125	24	54	54	M27x2	10	60	48	147	32	57	65	70	8	2060	KF-24125

**Piston rod locknut (zinc-plated steel)**



Material: Zinc-plated steel

Ø	KK	KV	KW	Mass g	Part no.
40	M12x1,25	19	7	10	KF-16040
50 - 63	M16x1,5	24	8	20	KF-16050
80 - 100	M20x1,5	30	9	30	KF-16080
125	M27x2	41	12	80	KF-16125

Slot positions for DF magnetic sensor

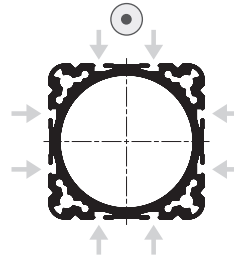
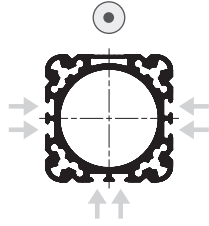
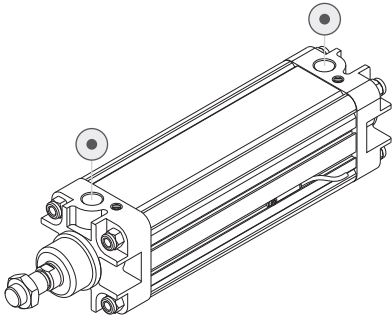

supply port

**KD Ø32 ÷ Ø63 mm**  
right/left and opposite  
to the supply port

**KD Ø80 ÷ Ø125 mm**  
all sides

Slot positions for DH magnetic sensor - K cylinder series

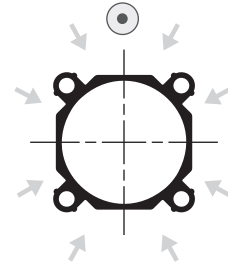
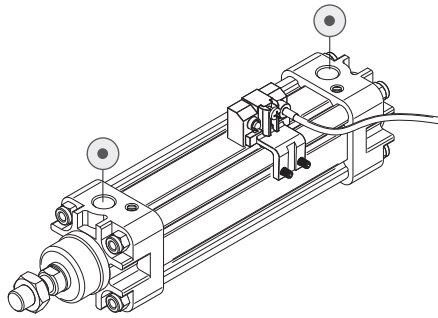
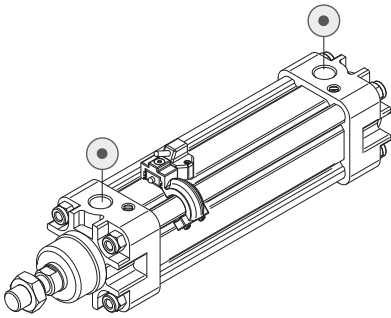

standard  
on all sides