

LKP010-2304/2305/2306

□ 22 mm - offset 75 mm

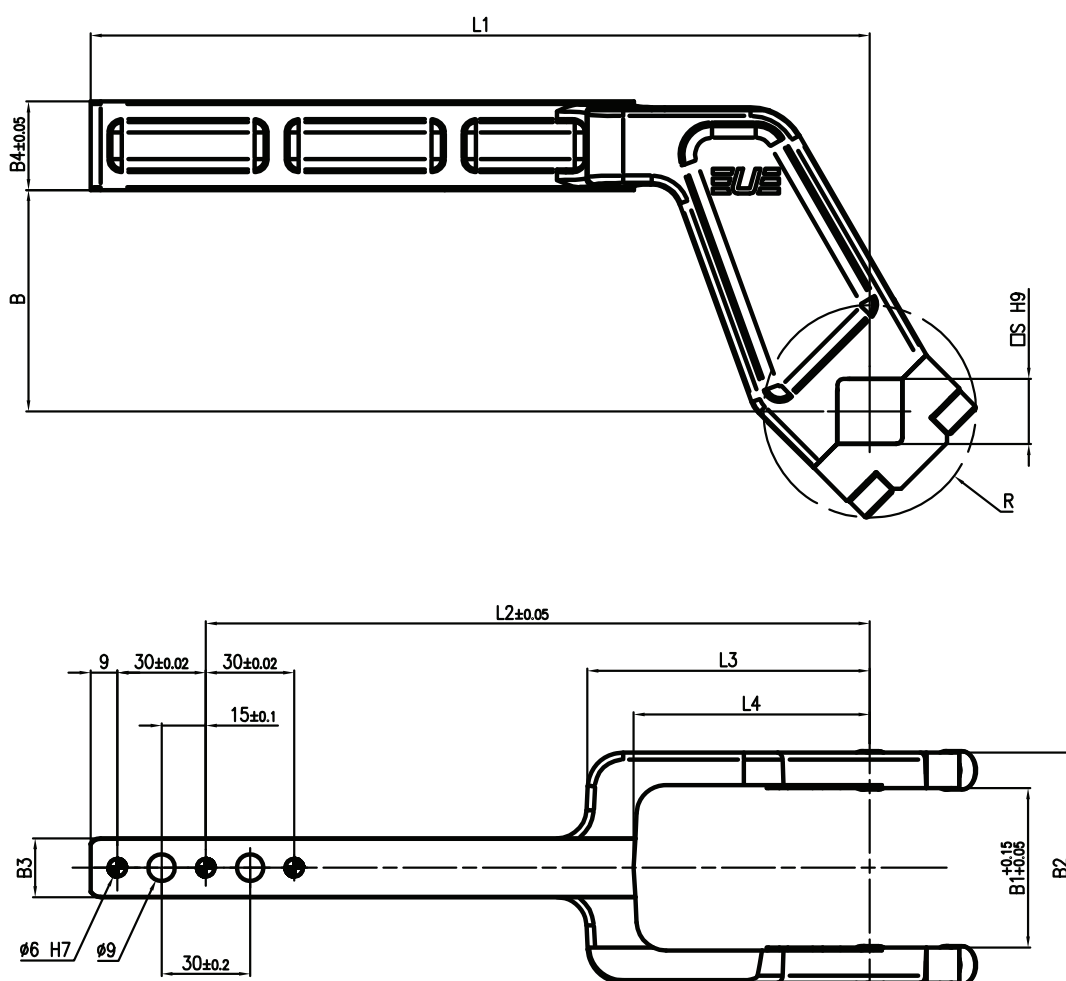

Part no.	B	B1	B2	B3	B4	L1	L2	L3	L4	R	S	Material
LKP010-2304	75	54	78	20	30	144	105	95	80	36	22	Steel
LKP010-2305	75	54	78	20	30	204	165	95	80	36	22	Steel
LKP010-2306	75	54	78	20	30	264	225	95	80	36	22	Steel