

W

Ø 12 ÷ 100 mm - Short stroke cylinders

The wide range of versions and the project originality make UNIVER Short stroke cylinders the perfect solution for those who need pneumatic cylinders with short strokes and compact dimensions. Thanks to their versatility, reliability and the different bore size availability, these cylinders are the ideal answer to the industry's demands.

Available ATEX version upon request

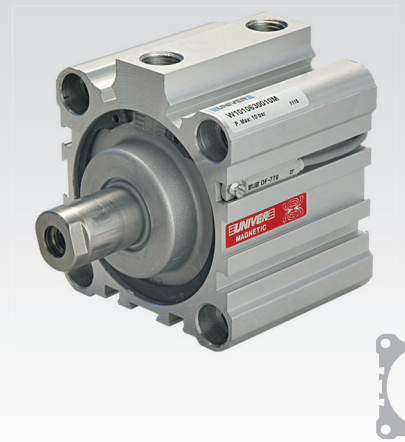

TECHNICAL CHARACTERISTICS

Ambient temperature	-20 ÷ 80 °C
Fluid	filtered air, with or without lubrication
Working pressure	1,5 ÷ 10 bar
Bores	Ø 12 - 16 - 20 - 25 - 32 - 40 - 50 - 63 - 80 - 100 mm

CONSTRUCTIVE CHARACTERISTICS

End-caps	aluminium
Barrel	anodized aluminium
Piston	aluminium
Guide slide	acetalic resin
Piston rod	rolled stainless steel (AISI 303)
Piston seal	nitrile rubber
Guide bush for piston rod	steel structure, PTFE and sintered bronze sliding
Piston rod scraper seal	polyurethane
Shock absorber seals	nitrile rubber in both sides
Magnet	plasto-ferrite

CODIFICATION KEY

W	1	0	0	0	3	2	0	0	5	0			
1	2	3	4		5			6	7	8			

1 Series	2 Type	3 Version	4 Bore (mm)
W = Ø 12÷100 mm Short Stroke Cylinders	1 = Stainless steel piston rod 7 = Stainless steel piston rod with male rear hinge, versions 00 - 10 - 60 - 70 (except for bore Ø12)	00 = D.A. Standard version 01 = D.A. Through piston rod 10 = D.A. Non-rotating piston rod (except for Ø 12) ^(a) 11 = D.A. Non-rotating through piston rod (except for Ø 12) ^(a) 31 = D.A. Hollow through piston rod (except for Ø 12-16) 60 = S.A. Retracted piston rod 70 = S.A. Extended piston rod D.A. = Double acting S.A. = Single acting	012 = Ø12 016 = Ø16 020 = Ø20 025 = Ø25 032 = Ø32 040 = Ø40 050 = Ø50 063 = Ø63 080 = Ø80 100 = Ø100

5 Stroke (mm)	6 Option	7 Magnetic	8 Atex option
Single acting 0005 - 0010 (Ø12÷25) 0005 - 0010 - 0025 (Ø32÷100) Double acting 0005 - 0010 - 0020 - 0025 0030 - 0040 - 0050 (Ø12-16) 0005 - 0010 - 0020 - 0025 0030 - 0040 - 0050 - 0075 (Ø20÷100)	S = Safety distance ^(a) (only for versions 10 and 11)	M = Magnetic version (except for Ø 12)	X = Atex (upon request) For types and versions, see ATEX catalogue

(a) = The cylinder types without safety distance requested by the customer have to be installed by the user in accordance with EC rules EN 294 EN 294 (vedi pag. 9)
Atex version not available

Stroke tolerances

Ø	Nominal tolerances mm
12	+ 1,5/0
16	+ 1,5/0
20	+ 1,5/0
25	+ 1,5/0
32	+ 2/0
40	+ 2/0
50	+ 2/0
63	+ 2,5/0
80	+ 2,5/0
100	+ 2,5/0

Theoretical forces (N) at working pressure (bar)

Ø	Surface area mm ²		Working pressure bar					Working pressure bar				
	Thrust	Traction	Thrust					Traction				
			2	4	6	8	10	2	4	6	8	10
12	113	85	23	45	68	90	113	17	34	51	68	85
16	201	173	40	80	121	161	201	35	69	104	138	173
20	314	236	63	126	188	251	314	47	94	142	189	236
25	491	412	98	196	295	393	491	82	165	247	330	412
32	804	691	161	322	482	643	804	138	276	414	553	691
40	1256	1056	251	502	754	1005	1256	211	422	633	844	1055
50	1962	1762	393	785	1178	1570	1963	352	704	1057	1409	1762
63	3116	2802	623	1246	1869	2493	3116	560	1120	1680	2240	2800
80	5024	4533	1005	2010	3014	4019	5024	907	1814	2722	3629	4536
100	7850	7359	1570	3140	4710	6280	7850	1472	2944	4416	5888	7360

Single acting cylinder Theoretical forces (N) for return stroke

Ø	Max force	Min force
12	6,8	2,6
16	7,8	4,1
20	13,2	7,8
25	19,6	11,7
32	35,3	17
40	45,6	21,5
50	70,5	24,6
63	96	41
80	119,5	52,9
100	237,2	118,5

1

Mass - Double acting cylinder

Ø	Cylinder - stroke 0		Increase per mm stroke g
	g		
	non-magnetic	magnetic	
12	45	-	1,20
16	74	102	1,40
20	95	120	2
25	135	155	2,85
32	233	292	4,06
40	394	430	5,47
50	390	446	6,40
63	640	772	9,70
80	1190	1275	14,85
100	1720	1920	19,70

Mass - Double acting through or hollow through piston rod cylinder

Ø	Cylinder - stroke 0		Increase per mm stroke g
	g		
	non-magnetic	magnetic	
12	55	-	1,40
16	86	114	1,60
20	112	137	2,65
25	165	185	3,50
32	295	354	5
40	500	536	7
50	478	534	8
63	790	922	12,2
80	1345	1430	18,7
100	1875	2075	23,6

Mass - Single acting retracted piston rod cylinder

Ø	Cylinder - stroke 0		Increase per mm stroke g
	g		
	non-magnetic	magnetic	
12	38	-	1,20
16	59	79	1,40
20	70	95	2
25	96	116	2,85
32	194	253	4,06
40	326	362	5,47
50	322	378	6,4
63	533	715	9,7
80	1020	1105	14,85
100	1490	1690	19,70

Mass - Single acting extended piston rod cylinder

Ø	Cylinder - stroke 0		Increase per mm stroke g
	g		
	non-magnetic	magnetic	
12	45	-	1,20
16	70	98	1,40
20	86	111	2
25	122	142	2,85
32	212	271	4,06
40	366	402	5,47
50	352	408	6,40
63	590	772	9,70
80	1104	1189	14,85
100	1576	1776	19,70

Mass - Double acting non-rotating piston rod cylinder

Ø	Cylinder - stroke 0		Increase per mm stroke
	g		
	non-magnetic	magnetic	
16	92	120	1,60
20	133	158	2,45
25	185	205	3,30
32	330	390	4,85
40	545	580	6,70
50	600	656	7,60
63	960	1092	11,50
80	1750	1835	17,25
100	2630	2830	22,80

Mass - Double acting non-rotating through piston rod cylinder

Ø	Cylinder - stroke 0		Increase per mm stroke
	g		
	non-magnetic	magnetic	
16	104	132	1,80
20	150	175	3,10
25	214	234	3,95
32	392	452	5,80
40	651	686	8,20
50	688	744	9,20
63	1110	1242	14
80	1905	1990	21
100	2785	2985	26,70

Mass - Double acting with male rear hinge cylinder

Ø	Cylinder - stroke 0		Increase per mm stroke
	Kg		
	non-magnetic	magnetic	
16	0,082	0,11	1,40
20	0,108	0,133	2
25	0,159	0,179	2,85
32	0,277	0,336	4,06
40	0,471	0,507	5,47
50	0,417	0,473	6,40
63	0,682	0,814	9,70
80	1,239	1,324	14,85
100	1,775	1,975	19,70

Mass - Double acting non-rotating piston rod with male rear hinge cylinder

Ø	Cylinder - stroke 0		Increase per mm stroke
	Kg		
	non-magnetic	magnetic	
16	0,12	0,140	1,60
20	0,14	0,160	2,45
25	0,189	0,190	3,30
32	0,340	0,360	4,85
40	0,510	0,560	6,70
50	0,480	0,499	7,60
63	0,820	0,850	11,50
80	1,330	1,50	17,25
100	1,980	2,10	22,80

Mass - Single acting retracted piston rod with male rear hinge cylinder

Ø	Cylinder - stroke 0		Increase per mm stroke
	Kg		
	non-magnetic	magnetic	
16	0,067	0,087	1,40
20	0,083	0,098	2
25	0,119	0,139	2,85
32	0,238	0,297	4,06
40	0,403	0,439	5,47
50	0,349	0,405	6,4
63	0,575	0,757	9,7
80	1,069	1,154	14,85
100	1,545	1,745	19,70

Mass - Single acting extended piston rod with male rear hinge cylinder

Ø	Cylinder - stroke 0		Increase per mm stroke
	Kg		
	non-magnetic	magnetic	
16	0,078	0,106	1,40
20	0,099	0,124	2
25	0,145	0,165	2,85
32	0,256	0,316	4,06
40	0,422	0,479	5,47
50	0,379	0,435	6,40
63	0,632	0,914	9,70
80	1,153	1,238	14,85
100	1,631	1,831	19,70

Bending load (on piston rod) diagrams

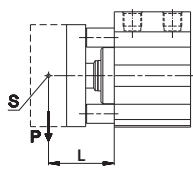

S = Point of application of load
 P = Load (N)
 L = Protrusion

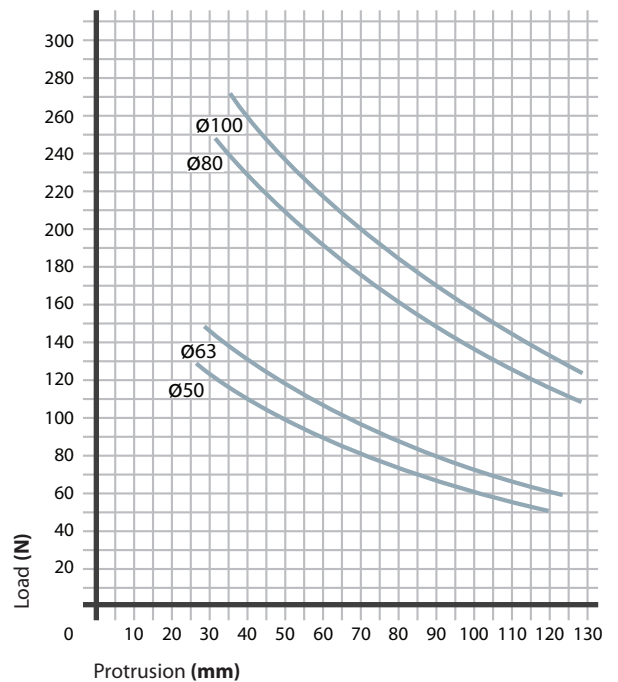
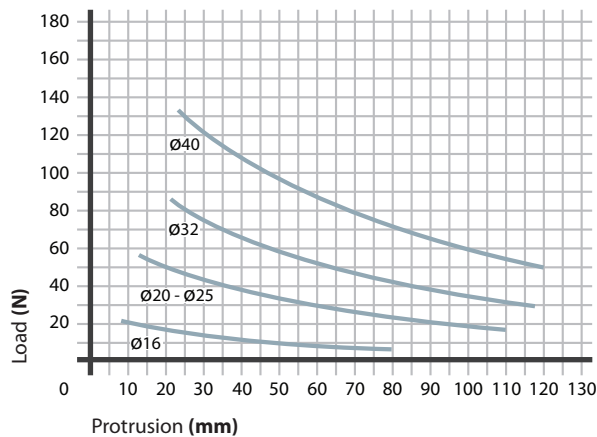

■ Fixing elements and accessories

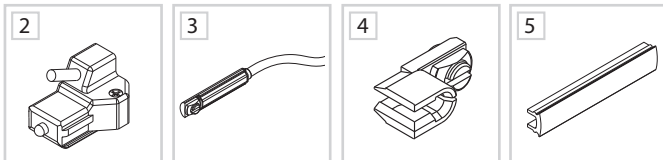
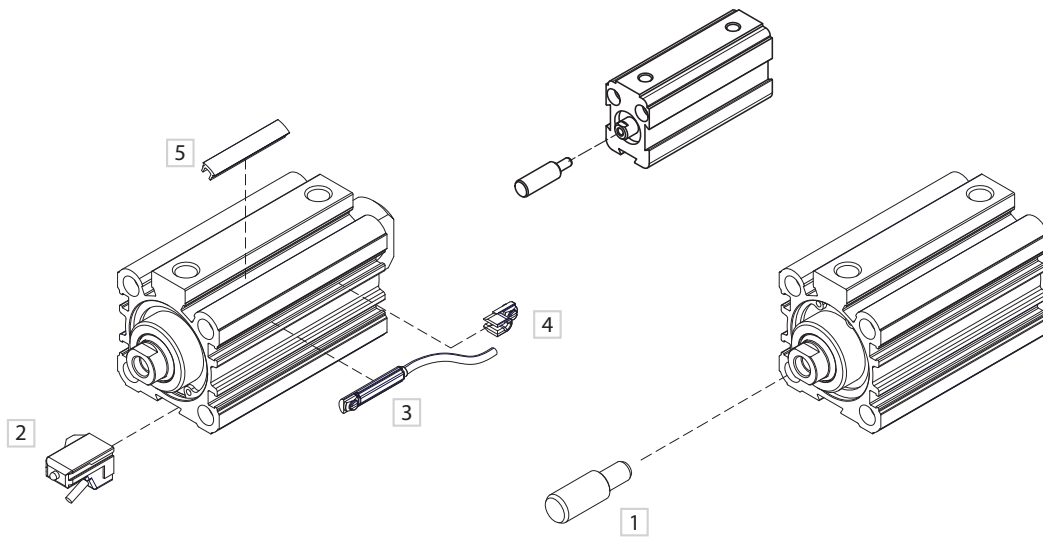

	DESCRIPTION	NOTE	PART NO.
1	Nipple		WF-50_ _ _
2	DH sensor		DH- _ _ _
3	DF sensor		DF- _ _ _
4	Cable clamping for DF sensor		DF-001
5	DHF covering strip		DHF-0020100

Double acting Ø12

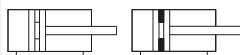
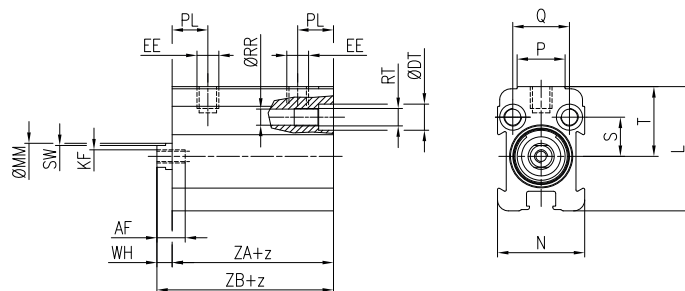
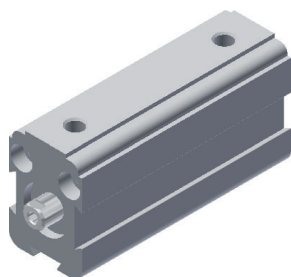

Double acting Ø16 ÷ Ø100

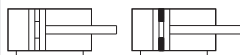
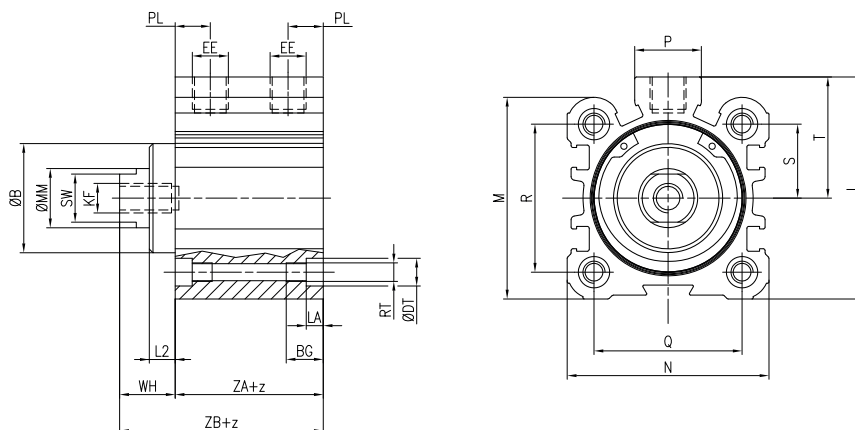
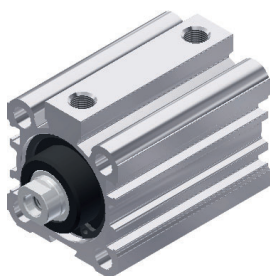

Z = Stroke

Ø	AF	B	BG	DT	EE	KF	L	LA	L2	M	MM	N	P
12	6,5	-	9	6	M5	M3	28,5	3,4	-	-	6	20	11
16	6,5	-	9	5,8	M5	M3	31	3,4	-	28	6	28	11
20	10	-	10	7,5	M5	M5	35	4,6	-	32	10	32	11
25	10	-	10	7,5	G1/8	M5	44,5	4,6	-	39	10	37	18
32	12	23	16	8,5	G1/8	M6	54	5,7	5	48	12	45	18
40	14	29,5	16	8,5	G1/8	M8	60	5,7	7	54,5	16	54,5	18
50	14	35,5	16	10,5	G1/4	M8	72	6,8	6,5	64	16	64	22
63	15	43	20	13,5	G1/4	M10	88	9	8,5	80	20	80	22
80	20	50	20	13,5	G3/8	M12	110	9	8	100	25	100	26
100	20	56	25	16,5	G3/8	M12	134	11	8	124	25	124	26

Ø	PL	Q	R	RR	RT	S	SW	T	WH	ZA	ZB	ZA	ZB
												Magnetic	
12	8,2	13	-	3,7	M4	9	5	16	3,5	32	35,5	-	-
16	6,5	20	20	3,7	M4	10	5	17	3,5	32	35,5	42	45,5
20	7	22	22	4,6	M5	11	8	19	7	35	42	45	52
25	7,5	26	28	4,6	M5	14	8	25	7	35	42	45	52
32	9	32	36	5,55	M6	18	10	30	12	37	49	47	59
40	9,5	40	40	5,55	M6	20	13	33	15	40	55	45	60
50	10	50	50	7,4	M8	25	13	40	15	40	55	45	60
63	10	62	62	9,3	M10	31	17	48	17	42	59	47	64
80	15	82	82	9,3	M10	41	22	60	19,5	52	71,5	57	76,5
100	15	103	103	11,2	M12	51,5	22	72	19,5	52	71,5	57	76,5

Double acting through piston rod Ø12

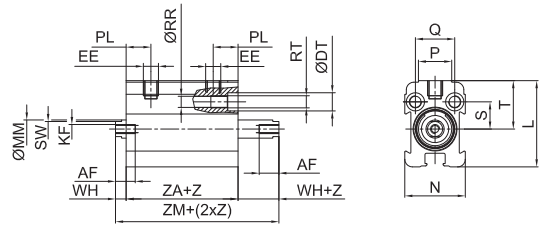
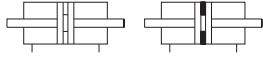
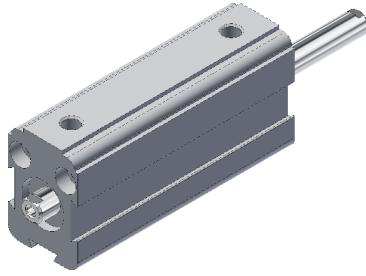

Double acting through piston rod Ø16 ÷ Ø100

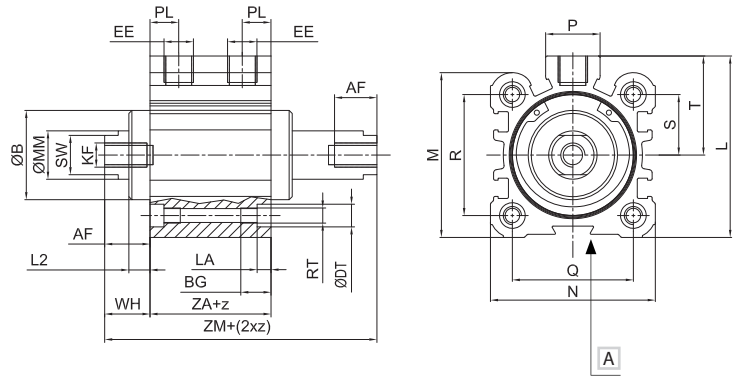
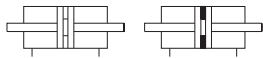
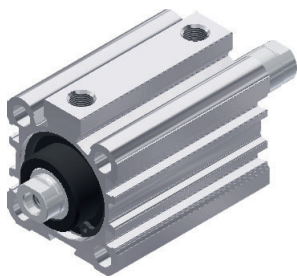

Double acting hollow through piston rod Ø20 ÷ Ø100

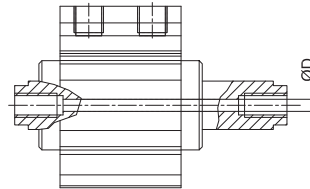
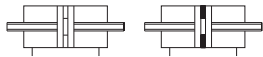

A Groove for sensor

Z = Stroke

Ø	AF	B	BG	D	DT	EE	KF	L	LA	L2	M	MM	N	P
12	6,5	-	9	-	6	M5	M3	28,5	3,4	-	-	6	20	11
16	6,5	-	9	-	5,8	M5	M3	31	3,4	-	28	6	28	11
20	10	-	10	2,5	7,5	M5	M5	35	4,6	-	32	10	32	11
25	10	-	10	2,5	7,5	G1/8	M5	44,5	4,6	-	39	10	37	18
32	12	23	16	3	8,5	G1/8	M6	54	5,7	5	48	12	45	18
40	14	29,5	16	4	8,5	G1/8	M8	60	5,7	7	54,5	16	54,5	18
50	14	35,5	16	4	10,5	G1/4	M8	72	6,8	6,5	64	16	64	22
63	15	43	20	6	13,5	G1/4	M10	88	9	8,5	80	20	80	22
80	20	50	20	6	13,5	G3/8	M12	110	9	8	100	25	100	26
100	20	56	25	6	16,5	G3/8	M12	134	11	8	124	25	124	26

Ø	PL	Q	R	RR	RT	S	SW	T	WH	ZA	ZM	ZA	ZM
12	8,2	13	-	3,7	M4	9	5	16	3,5	37	44	-	-
16	6,5	20	20	3,7	M4	10	5	17	3,5	37	44	47	54
20	7	22	22	4,6	M5	11	8	19	7	40	54	50	64
25	7,5	26	28	4,6	M5	14	8	25	7	40	54	50	64
32	9	32	36	5,55	M6	18	10	30	12	42	66	52	76
40	9,5	40	40	5,55	M6	20	13	33	15	45	75	50	80
50	10	50	50	7,4	M8	25	13	40	15	45	75	50	80
63	10	62	62	9,3	M10	31	17	48	17	47	81	52	86
80	15	82	82	9,3	M10	41	22	60	19,5	52	91	57	96
100	15	103	103	11,2	M12	51,5	22	72	19,5	52	91	57	96

Single acting retracted piston rod Ø12

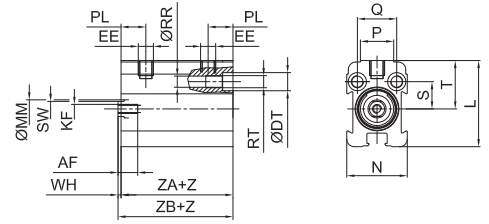
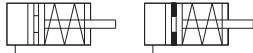
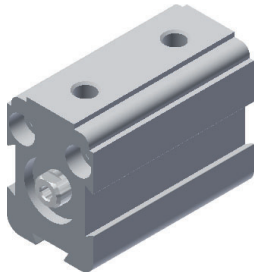

Single acting retracted piston rod Ø16 ÷ Ø100

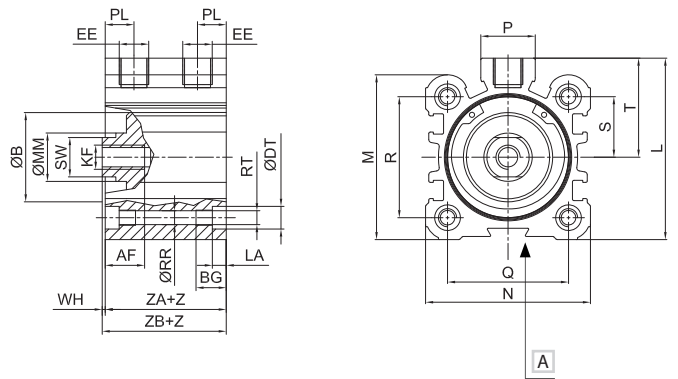
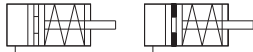
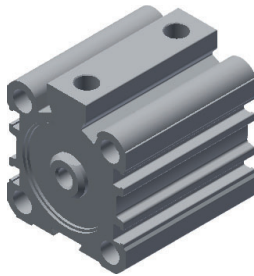

A Groove for sensor

Z = Stroke

Ø	AF	BG	DT	EE	KF	L	LA	M	MM	N	P	PL
12	6,5	9	6	M5	M3	28,5	3,4	-	6	20	11	8,2
16	6,5	9	5,8	M5	M3	31	3,4	28	6	28	11	6,5
20	10	10	7,5	M5	M5	35	4,6	32	10	32	11	7
25	10	10	7,5	G1/8	M5	44,5	4,6	39	10	37	18	7,5
32	12	16	8,5	G1/8	M6	54	5,7	48	12	45	18	9
40	14	16	8,5	G1/8	M8	60	5,7	54,5	16	54,5	18	9,5
50	14	16	10,5	G1/4	M8	72	6,8	64	16	64	22	10
63	15	20	13,5	G1/4	M10	88	9	80	20	80	22	10
80	20	20	13,5	G3/8	M12	110	9	100	25	100	26	15
100	20	25	16,5	G3/8	M12	134	11	124	25	124	26	15

Ø	Q	R	RR	RT	S	SW	T	WH	ZA	ZB	ZA	ZB
											Magnetic	
12	13	-	3,7	M4	9	5	16	1	27	28	-	-
16	20	20	3,7	M4	10	5	17	1	22	23	37	38
20	22	22	4,6	M5	11	8	19	1	25	26	40	41
25	26	28	4,6	M5	14	8	25	1	25	26	40	41
32	32	36	5,55	M6	18	10	30	1	32	33	47	48
40	40	40	5,55	M6	20	13	33	1	35	36	45	46
50	50	50	7,4	M8	25	13	40	1	35	36	45	46
63	62	62	9,3	M10	31	17	48	2	37	39	47	49
80	82	82	9,3	M10	41	22	60	6	47	53	57	63
100	103	103	11,2	M12	51,5	22	72	6	47	53	57	63

Single acting extended piston rod Ø12

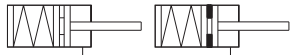
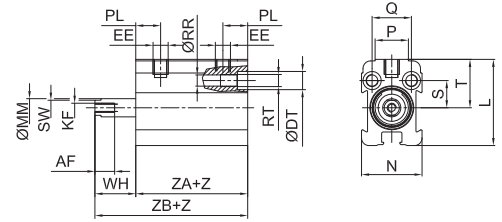
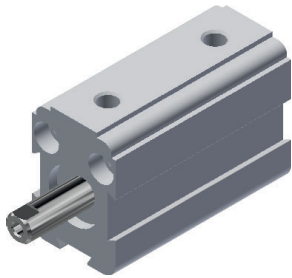

Single acting extended piston rod Ø16 ÷ Ø100

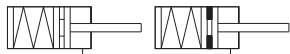
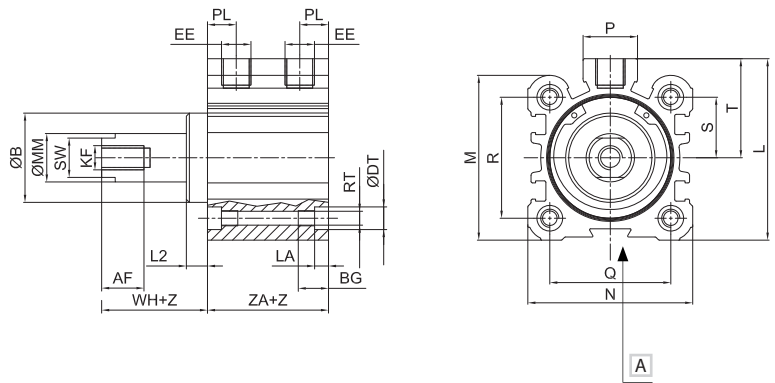
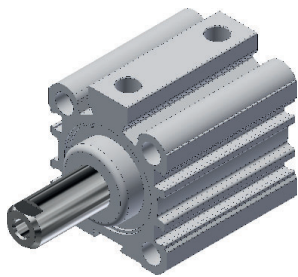

A Groove for sensor

Z = Stroke

Ø	AF	B	BG	DT	EE	KF	L	LA	L2	M	MM	N
12	6,5	-	9	6	M5	M3	28,5	3,4	-	-	6	20
16	6,5	-	9	5,8	M5	M3	31	3,4	-	28	6	28
20	10	-	10	7,5	M5	M5	35	4,6	-	32	10	32
25	10	-	10	7,5	G1/8	M5	44,5	4,6	-	39	10	37
32	12	23	16	8,5	G1/8	M6	54	5,7	5	48	12	45
40	14	29,5	16	8,5	G1/8	M8	60	5,7	7	54,5	16	54,5
50	14	35,5	16	10,5	G1/4	M8	72	6,8	6,5	64	16	64
63	15	43	20	13,5	G1/4	M10	88	9	8,5	80	20	80
80	20	50	20	13,5	G3/8	M12	110	9	8	100	25	100
100	20	56	25	16,5	G3/8	M12	134	11	8	124	25	124

Ø	P	PL	Q	R	RR	RT	S	SW	T	WH	ZA	ZA
12	11	8,2	13	-	3,7	M4	9	5	16	3,5	32	-
16	11	6,5	20	20	3,7	M4	10	5	17	3,5	27	42
20	11	7	22	22	4,6	M5	11	8	19	7	30	45
25	18	7,5	26	28	4,6	M5	14	8	25	7	30	47
32	18	9	32	36	5,55	M6	18	10	30	12	32	45
40	18	9,5	40	40	5,55	M6	20	13	33	15	35	45
50	22	10	50	50	7,4	M8	25	13	40	15	35	45
63	22	10	62	62	9,3	M10	31	17	48	17	37	47
80	26	15	82	82	9,3	M10	41	22	60	19,5	47	57
100	26	15	103	103	11,2	M12	51,5	22	72	19,5	47	57

Magnetic

Double acting non-rotating piston rod Ø16 ÷ Ø100

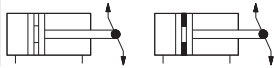
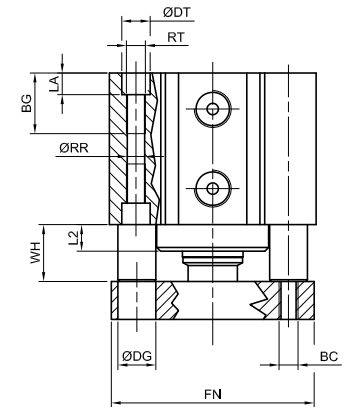
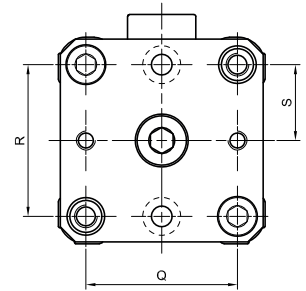
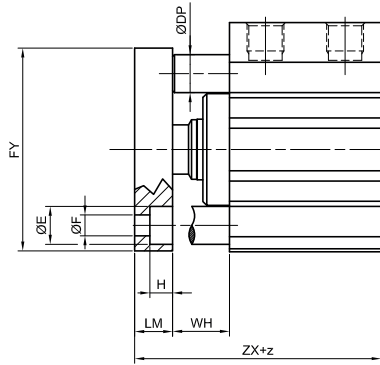
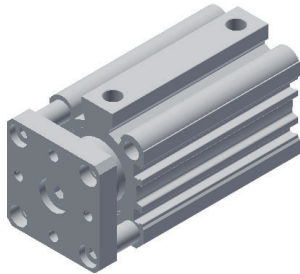

Double acting non-rotating piston rod and safety distance Ø16 ÷ Ø100

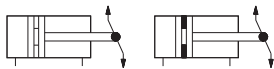
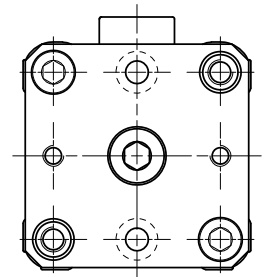
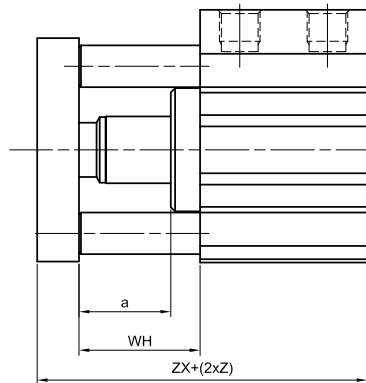
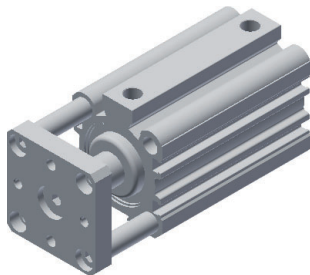

Accident prevention safety distance in accordance with EC rules EN 294 to be provided by the user

A Groove for sensor

Z = Stroke

Ø	BC	BG	DG	DP	DT	E	F	FN	FY	H	LA	LM
16	M3	9	6	4	5,8	6	3,5	27,5	27,5	3,5	3,4	7
20	M4	10	7,5	6	7,5	7,5	4,5	31,5	31,5	4,5	4,6	8
25	M4	10	7,5	6	7,5	7,5	4,5	36	38	5	4,6	8
32	M4	16	10	8	8,5	10	5,5	44,5	47,5	6	5,7	10
40	M5	16	10	10	8,5	10	5,5	53,5	53,5	6	5,7	10
50	M6	16	11	10	10,5	11	6,5	63,5	63,5	7	6,8	12
63	M6	20	15	12	13,5	14	9	79,5	79,5	9	9	12
80	M8	20	15	14	13,5	14	9	99,5	99,5	9	9	14
100	M8	25	17	16	16,5	16,5	10,5	123,5	123,5	10,5	11	16

> Safety distance version available

Ø	L2	Q	R	RR	S	WH	ZX	ZX Magnetic	a	WH	ZX	ZX Magnetic
16	-	20	20	3,7	10	3,5	42,5	52,5	28,5	28,5	67,5	77,5
20	-	22	22	4,6	11	7	50	60	27	27	70	80
25	-	26	28	4,6	14	7	50	60	27	27	70	80
32	5	32	36	5,55	18	12	59	69	27	32	79	89
40	7	40	40	5,55	20	15	65	70	28	35	85	90
50	6,5	50	50	7,4	25	15	67	72	28,5	35	87	92
63	8,5	62	62	9,3	31	17	71	76	28,5	37	91	96
80	8	82	82	9,3	41	19,5	85,5	90,5	26,5	34,5	100,5	105,5
100	8	103	103	11,2	51,5	19,5	87,5	92,5	26,5	34,5	102,5	107,5

Double acting non-rotating through piston rod Ø16 ÷ Ø100

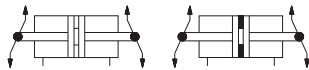
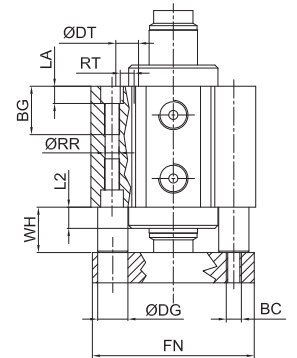
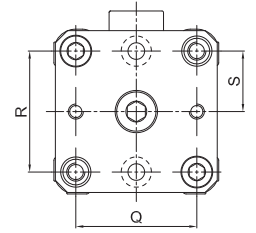
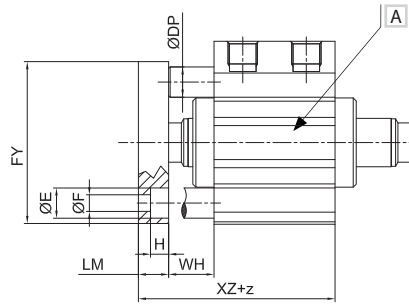
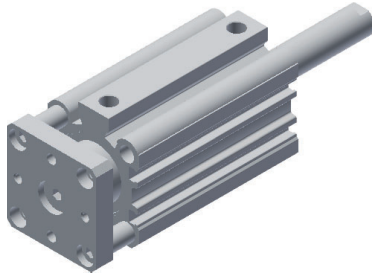

Double acting non-rotating through piston rod and safety distance Ø16 ÷ Ø100

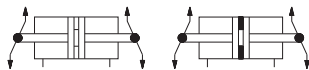
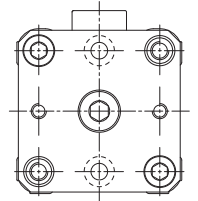
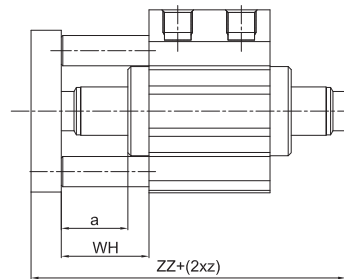
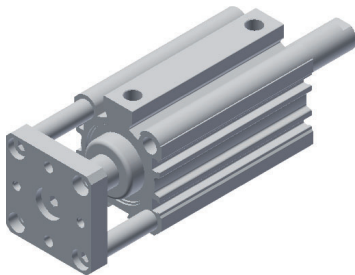

Accident prevention safety distance in accordance with EC rules EN 294 to be provided by the user

A Groove for sensor

Z = Stroke

Ø	BC	BG	DG	DP	DT	E	F	FN	FY	H	LA	LM
16	M3	9	6	4	5,8	6	3,5	27,5	27,5	3,5	3,4	7
20	M4	10	7,5	6	7,5	7,5	4,5	31,5	31,5	4,5	4,6	8
25	M4	10	7,5	6	7,5	7,5	4,5	36	38	5	4,6	8
32	M4	16	10	8	8,5	10	5,5	44,5	47,5	6	5,7	10
40	M5	16	10	10	8,5	10	5,5	53,5	53,5	6	5,7	10
50	M6	16	11	10	10,5	11	6,5	63,5	63,5	7	6,8	12
63	M6	20	15	12	13,5	14	9	79,5	79,5	9	9	12
80	M8	20	15	14	13,5	14	9	99,5	99,5	9	9	14
100	M8	25	17	16	16,5	16,5	10,5	123,5	123,5	10,5	11	16

> Safety distance version available

Ø	L2	Q	R	RR	S	WH	ZZ	ZZ	a	WH	ZZ	ZZ
								Magnetic				Magnetic
16	-	20	20	3,7	10	3,5	51	61	28,5	28,5	76	86
20	-	22	22	4,6	11	7	62	72	27	27	82	92
25	-	26	28	4,6	14	7	62	72	27	27	82	92
32	5	32	36	5,55	18	12	76	86	27	32	96	106
40	7	40	40	5,55	20	15	85	90	28	35	105	110
50	6,5	50	50	7,4	25	15	87	92	28,5	35	107	112
63	8,5	62	62	9,3	31	17	93	98	28,5	37	113	118
80	8	82	82	9,3	41	19,5	105	110	26,5	34,5	120	125
100	8	103	103	11,2	51,5	19,5	107	112	26,5	34,5	122	127

Male rear hinge Ø16 ÷ Ø100

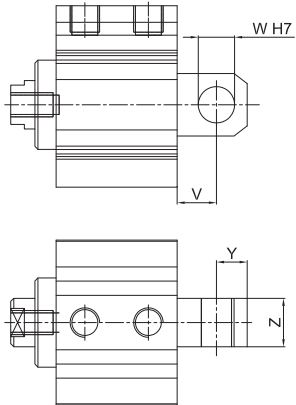

Ø	Y	Z	W	V
16	5,5	9	6	6,2
20	5,5	9	6	6,5
25	6	12	6	8
32	9	14	10	11
40	10	16	12	13
50	12	17	12	16,5
63	14	21	16	18
80	14	21	16	16,5
100	17	25	20	21

Tandem version

CODIFICATION KEY

W	1	A	0	3	2	0	5	0	
1	2	3	4	5					

1 Series	2 Type	3 Bore (mm)	4 Stroke (mm)	5 Magnetic
W = Ø 12÷100 mm Short Stroke Cylinders	1A = Double thrust tandem only for forward movement	012 = Ø12 016 = Ø16 020 = Ø20 025 = Ø25 032 = Ø32	040 = Ø40 050 = Ø50 063 = Ø63 080 = Ø80 100 = Ø100	Z1/Z2 Upon request M = Magnetic version (upon request)

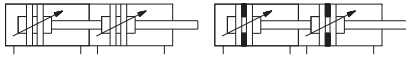
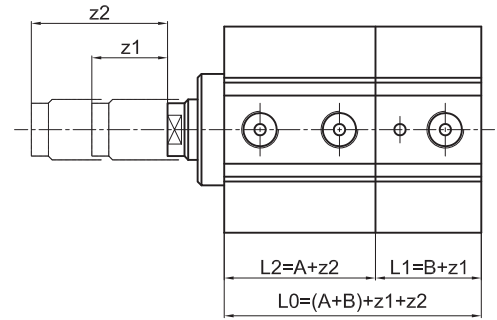

Ø	Tandem			Tandem magnetic		
	L2 = A + Z2	L1 = B + Z1	L0 = (A + B) + Z1 + Z2	L2 = A + Z2	L1 = B + Z1	L0 = (A + B) + Z1 + Z2
16	L2 = 37 + Z2	L1 = 22 + Z1	L0 = 59 + Z1 + Z2	L2 = 47 + Z2	L1 = 37 + Z1	L0 = 84 + Z1 + Z2
20	L2 = 40 + Z2	L1 = 25 + Z1	L0 = 65 + Z1 + Z2	L2 = 50 + Z2	L1 = 40 + Z1	L0 = 90 + Z1 + Z2
25	L2 = 40 + Z2	L1 = 25 + Z1	L0 = 65 + Z1 + Z2	L2 = 50 + Z2	L1 = 40 + Z1	L0 = 90 + Z1 + Z2
32	L2 = 42 + Z2	L1 = 23 + Z1	L0 = 65 + Z1 + Z2	L2 = 52 + Z2	L1 = 38 + Z1	L0 = 90 + Z1 + Z2
40	L2 = 45 + Z2	L1 = 26,5 + Z1	L0 = 71,5 + Z1 + Z2	L2 = 50 + Z2	L1 = 36,5 + Z1	L0 = 86,5 + Z1 + Z2
50	L2 = 45 + Z2	L1 = 26 + Z1	L0 = 71 + Z1 + Z2	L2 = 50 + Z2	L1 = 36 + Z1	L0 = 86 + Z1 + Z2
63	L2 = 47 + Z2	L1 = 29 + Z1	L0 = 76 + Z1 + Z2	L2 = 52 + Z2	L1 = 39 + Z1	L0 = 91 + Z1 + Z2
80	L2 = 52 + Z2	L1 = 38 + Z1	L0 = 90 + Z1 + Z2	L2 = 57 + Z2	L1 = 48 + Z1	L0 = 105 + Z1 + Z2
100	L2 = 52 + Z2	L1 = 38 + Z1	L0 = 90 + Z1 + Z2	L2 = 57 + Z2	L1 = 48 + Z1	L0 = 105 + Z1 + Z2

Two-position tandem version

CODIFICATION KEY

W	1	B	0	3	2	0	5	0	0	9	0
1	2	3	4	5	6						

1 Series	2 Type	3 Bore (mm)	4 Stroke 1 (mm)	5 Stroke 2 (mm)	6 Magnetic	
W = Ø 12÷100 mm Short Stroke Cylinders	1B = Two-position tandem	012 = Ø12 016 = Ø16 020 = Ø20 025 = Ø25 032 = Ø32	040 = Ø40 050 = Ø50 063 = Ø63 080 = Ø80 100 = Ø100	Stroke of rear cylinder Upon request	Stroke of head cylinder Upon request	M = Magnetic version (upon request)

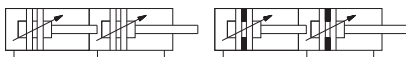
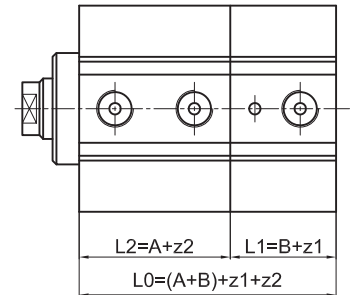

Ø	Tandem			Tandem magnetic		
	L2 = A + Z2	L1 = B + Z1	L0 = (A + B) + Z1 <+ Z2	L2 = A + Z2	L1 = B + Z1	L0 = (A + B) + Z1 <+ Z2
16	L2 = 37 + Z2	L1 = 22 + Z1	L0 = 59 + Z1 <+ Z2	L2 = 47 + Z2	L1 = 37 + Z1	L0 = 84 + Z1 <+ Z2
20	L2 = 40 + Z2	L1 = 25 + Z1	L0 = 65 + Z1 <+ Z2	L2 = 50 + Z2	L1 = 40 + Z1	L0 = 90 + Z1 <+ Z2
25	L2 = 40 + Z2	L1 = 25 + Z1	L0 = 65 + Z1 <+ Z2	L2 = 50 + Z2	L1 = 40 + Z1	L0 = 90 + Z1 <+ Z2
32	L2 = 42 + Z2	L1 = 23 + Z1	L0 = 65 + Z1 <+ Z2	L2 = 52 + Z2	L1 = 38 + Z1	L0 = 90 + Z1 <+ Z2
40	L2 = 45 + Z2	L1 = 26,5 + Z1	L0 = 71,5 + Z1 <+ Z2	L2 = 50 + Z2	L1 = 36,5 + Z1	L0 = 86,5 + Z1 <+ Z2
50	L2 = 45 + Z2	L1 = 26 + Z1	L0 = 71 + Z1 <+ Z2	L2 = 50 + Z2	L1 = 36 + Z1	L0 = 87 + Z1 <+ Z2
63	L2 = 47 + Z2	L1 = 29 + Z1	L0 = 76 + Z1 <+ Z2	L2 = 52 + Z2	L1 = 39 + Z1	L0 = 91 + Z1 <+ Z2
80	L2 = 52 + Z2	L1 = 38 + Z1	L0 = 90 + Z1 <+ Z2	L2 = 57 + Z2	L1 = 48 + Z1	L0 = 105 + Z1 <+ Z2
100	L2 = 52 + Z2	L1 = 38 + Z1	L0 = 90 + Z1 <+ Z2	L2 = 57 + Z2	L1 = 48 + Z1	L0 = 105 + Z1 <+ Z2

Stroke C1 is always lower than stroke C2

Three-position tandem version WS (upon request)

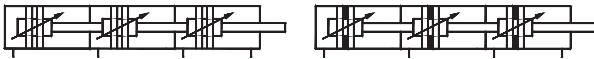
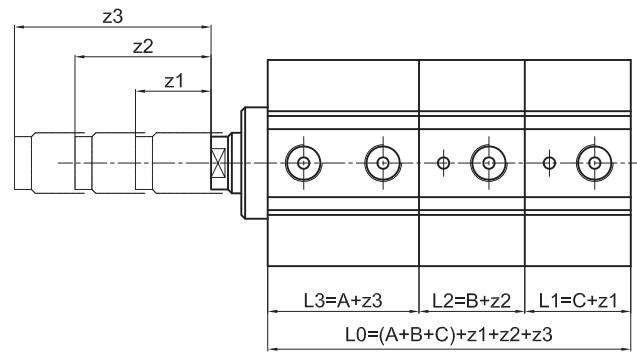

Ø	Tandem				Tandem magnetic			
	L3 = A + Z3	L2 = B + Z2	L1 = D + Z1	L0 = (A + B + D) + Z1 + Z2 + Z3	L3 = A + Z3	L2 = B + Z2	L1 = D + Z1	L0 = (A + B + D) + Z1 + Z2 + Z3
16	L3 = 37 + Z3	L2 = 27 + Z2	L1 = 22 + Z1	L0 = 86 + Z1 + Z2 + Z3	L3 = 47 + Z3	L2 = 42 + Z2	L1 = 37 + Z1	L0 = 126 + Z1 + Z2 + Z3
20	L3 = 40 + Z3	L2 = 30 + Z2	L1 = 25 + Z1	L0 = 95 + Z1 + Z2 + Z3	L3 = 50 + Z3	L2 = 45 + Z2	L1 = 40 + Z1	L0 = 135 + Z1 + Z2 + Z3
25	L3 = 40 + Z3	L2 = 30 + Z2	L1 = 25 + Z1	L0 = 95 + Z1 + Z2 + Z3	L3 = 50 + Z3	L2 = 45 + Z2	L1 = 40 + Z1	L0 = 135 + Z1 + Z2 + Z3
32	L3 = 42 + Z3	L2 = 28 + Z2	L1 = 23 + Z1	L0 = 93 + Z1 + Z2 + Z3	L3 = 52 + Z3	L2 = 43 + Z2	L1 = 38 + Z1	L0 = 133 + Z1 + Z2 + Z3
40	L3 = 45 + Z3	L2 = 31,5 + Z2	L1 = 26,5 + Z1	L0 = 103 + Z1 + Z2 + Z3	L3 = 50 + Z3	L2 = 41,5 + Z2	L1 = 36,5 + Z1	L0 = 128 + Z1 + Z2 + Z3
50	L3 = 45 + Z3	L2 = 31 + Z2	L1 = 26 + Z1	L0 = 102 + Z1 + Z2 + Z3	L3 = 50 + Z3	L2 = 41 + Z2	L1 = 36 + Z1	L0 = 127 + Z1 + Z2 + Z3
63	L3 = 47 + Z3	L2 = 36 + Z2	L1 = 29 + Z1	L0 = 112 + Z1 + Z2 + Z3	L3 = 52 + Z3	L2 = 44 + Z2	L1 = 39 + Z1	L0 = 135 + Z1 + Z2 + Z3
80	L3 = 52 + Z3	L2 = 38 + Z2	L1 = 38 + Z1	L0 = 128 + Z1 + Z2 + Z3	L3 = 57 + Z3	L2 = 48 + Z2	L1 = 48 + Z1	L0 = 153 + Z1 + Z2 + Z3
100	L3 = 52 + Z3	L2 = 38 + Z2	L1 = 38 + Z1	L0 = 128 + Z1 + Z2 + Z3	L3 = 57 + Z3	L2 = 48 + Z2	L1 = 48 + Z1	L0 = 153 + Z1 + Z2 + Z3

For all other dimensions please refer to the standard version
Options with non-rotating piston rod are also possible

Nipple

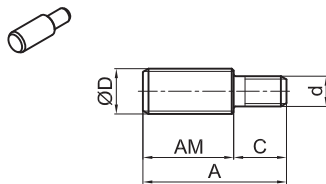

Fixing screws

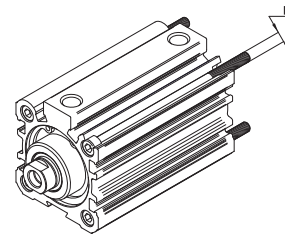

Material: Zinc-plated steel

Cylinder Ø	A	AM	C	D	d	Part no.
12 - 16	22,5	16	6,5	6x1	M3	WF-50012
20 - 25	30	20	10	8x1,25	M5	WF-50020
32	34	22	12	10x1,25	M6	WF-50032
40	38	24	14	12x1,25	M8	WF-50040
50	46	32	14	16x1,5	M8	WF-50050
63	47	32	15	16x1,5	M10	WF-50063
80 - 100	60	40	20	20x1,5	M12	WF-50080

Cylinder Ø	12	16*	20	25	32	40	50	63	80	100
M	3	3	4	4	5	5	6	8	8	10

* = only for bore 16 (magnetic version), the fixing screws have to be non-magnetic

Slot positions for DF - DH magnetic sensors

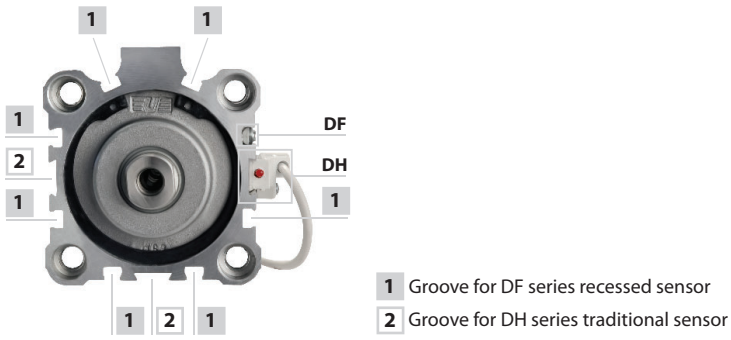

Ø 12 mm



Ø 16-20 mm



Ø 25-32 mm



Ø 40 mm

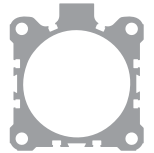

Ø 50-63-80-100 mm

1